

# AIR CONDITIONER

## Wall Mounted Type

# INSTALLATION MANUAL



PART No. 9333893006-02

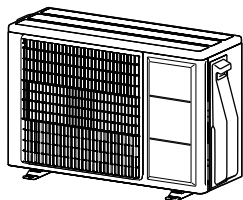
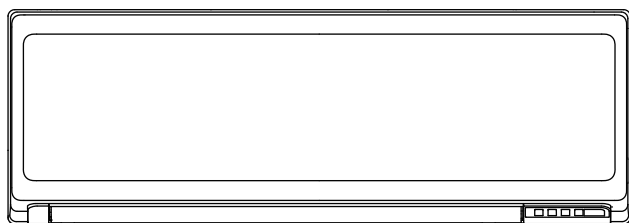

### Contents

1. SAFETY PRECAUTIONS.....	1
2. PRODUCT SPECIFICATION.....	4
4. INSTALLATION WORK.....	5
5. ELECTRICAL WIRING.....	7
6. REMOVING AND REPLACING PARTS.....	8
7. REMOTE CONTROLLER INSTALLATION.....	9
8. FUNCTION SETTING.....	9
9. OPTIONAL KIT INSTALLATION.....	11
10. INSTALLATION WORK.....	11
11. ELECTRICAL WIRING.....	12
12. PIPE INSTALLATION.....	14
13. FINISHING.....	15
14. TEST RUN.....	15
15. CUSTOMER GUIDANCE.....	15
16. ERROR CODES.....	16

## 1. SAFETY PRECAUTIONS

- Be sure to read this manual thoroughly before installation.
- The warnings and precautions indicated in this manual contain important information pertaining to your safety. Be sure to observe them.
- Hand this manual, together with the operating manual, to the customer. Request the customer to keep them on hand for future use, such as for relocating or repairing the unit.

### WARNING

Indicates a potentially or imminently hazardous situation which, if not avoided, could result in death or serious injury.

### CAUTION

Indicates a potentially hazardous situation that may result in minor or moderate injury or damage to property.

### WARNING

- Installation of this product must be done by experienced service technicians or professional installers only in accordance with this manual. Installation by nonprofessional or improper installation of the product may cause serious accidents such as injury, water leakage, electric shock, or fire. If the product is installed in disregard of the instructions in this manual, it will void the manufacturer's warranty.
- To avoid getting an electric shock, never touch the electrical components soon after the power supply has been turned off. After turning off the power, always wait 10 minutes or more before you touch the electrical components.
- Do not turn on the power until all work has been completed. Turning on the power before the work is completed can cause serious accidents such as electric shock or fire.
- If refrigerant leaks while work is being carried out, ventilate the area. If the refrigerant comes in contact with a flame, it produces a toxic gas.

[Original instructions]

For authorized service personnel only.

- Installation must be performed in accordance with regulations, codes, or standards for electrical wiring and equipment in each country, region, or the installation place.
- Do not use this equipment with air or any other unspecified refrigerant in the refrigerant lines. Excess pressure can cause a rupture.
- During installation, make sure that the refrigerant pipe is attached firmly before you run the compressor.  
Do not operate the compressor under the condition of refrigerant piping not attached properly with 3-way valve open. This may cause abnormal pressure in the refrigeration cycle that leads to rupture and even injury.
- When installing or relocating the air conditioner, do not mix gases other than the specified refrigerant (R32) to enter the refrigerant cycle.  
If air or other gas enters the refrigerant cycle, the pressure inside the cycle will rise to an abnormally high value and cause rupture, injury, etc.
- To connect the indoor unit and outdoor unit, use air conditioner piping and cables available locally as standard parts. This manual describes proper connections using such installation set.
- Do not modify power cable, use extension cable or branch wiring. Improper use may cause electric shock or fire by poor connection, insufficient insulation or over current.
- Do not purge the air with refrigerants but use a vacuum pump to vacuum the installation.
- There is not extra refrigerant in the outdoor unit for air purging.
- Use a vacuum pump for R32 or R410A exclusively.
- Using the same vacuum pump for different refrigerants may damage the vacuum pump or the unit.
- Use a clean gauge manifold and charging hose for R32 or R410A exclusively.
- Do not use means to accelerate the defrosting process or to clean, other than those recommended by the manufacturer.
- The appliance shall be stored in a room without continuously operating ignition sources (for example: open flames, an operating gas appliance or an operating electric heater).
- Do not pierce or burn.
- Be aware that refrigerants may not contain an odour.
- During the pump-down operation, make sure that the compressor is turned off before you remove the refrigerant piping.  
Do not remove the connection pipe while the compressor is in operation with 3-way valve open.  
This may cause abnormal pressure in the refrigeration cycle that leads to rupture and even injury.
- This appliance is not intended for use by persons (including children) with reduced physical, sensory or mental capabilities, or lack of experience and knowledge, unless they have been given supervision or instruction concerning use of the appliance by a person responsible for their safety. Children should be supervised to ensure that they do not play with the appliance.
- To avoid danger of suffocation, keep the plastic bag or thin film used as the packaging material away from young children.

### CAUTION

- For the air conditioner to work appropriately, install it as written in this manual.
  - The appliance shall not be installed in an unventilated space, if that space is smaller than 1.61 m<sup>2</sup>.
  - This product must be installed by qualified personnel with a capacity certification of handling refrigerant fluids. Refer to regulation and laws in use on installation place.
  - Install the product by following local codes and regulations in force at the place of installation, and the instructions provided by the manufacturer.
  - This product is part of a set constituting an air conditioner. The product must not be installed alone or be installed with non-authorized device by the manufacturer.
  - Always use a separate power supply line protected by a circuit breaker operating on all wires with a distance between contact of 3 mm for this product.
  - To protect the persons, earth (ground) the product correctly, and use the power cable combined with an Earth Leakage Circuit Breaker (ELCB).
  - This product is not explosion proof, and therefore should not be installed in explosive atmosphere.
  - This product contains no user-serviceable parts. Always consult experienced service technicians for repairing.
  - When installing pipes shorter than 3 m, sound of the outdoor unit will be transferred to the indoor unit, which will cause large operating sound or some abnormal sound.
  - When moving or relocating the air conditioner, consult experienced service technicians for disconnection and reinstallation of the product.
  - Do not touch the fins of the heat exchanger. Touching the heat exchanger fins could result in damage to the fins or personal injury such as skin rupture.
  - Do not touch the aluminum fins of heat exchanger built-in the indoor or outdoor unit to avoid personal injury when you install or maintain the unit.
  - Do not place any other electrical products or household belongings under the indoor unit. Condensation dripping from the indoor unit might get them wet, and may cause damage or malfunction to the property.
- Be careful not to scratch the air conditioner when handling it.

English

Deutsch

Français

Español

Italiano

Ελληνικά

Portugués

Türkçe

## Precautions for using R32 refrigerant

The basic installation work procedures are the same as conventional refrigerant (R410A, R22) models.

However, pay careful attention to the following points:

Since the working pressure is 1.6 times higher than that of refrigerant R22 models, some of the piping and installation and service tools are special. (See "2.1. Special tools for R32 (R410A)".)

Especially, when replacing a refrigerant R22 model with a new refrigerant R32 model, always replace the conventional piping and flare nuts with the R32 and R410A piping and flare nuts on the outdoor unit side.

For R32 and R410A, the same flare nut on the outdoor unit side and pipe can be used.

Models that use refrigerant R32 and R410A have a different charging port thread diameter to prevent erroneous charging with refrigerant R22 and for safety. Therefore, check beforehand. [The charging port thread diameter for R32 and R410A is 1/2-20 UNF.]

Be more careful than R22 so that foreign matter (oil, water, etc.) does not enter the piping. Also, when storing the piping, securely seal the opening by pinching, taping, etc. (Handling of R32 is similar to R410A.)

### CAUTION

#### 1-Installation (Space)

- That the installation of pipe-work shall be kept to a minimum.
- That pipe-work shall be protected from physical damage.
- That compliance with national gas regulations shall be observed.
- That mechanical connections shall be accessible for maintenance purposes.
- In cases that require mechanical ventilation, ventilation openings shall be kept clear of obstruction.
- When disposing of the product is used, be based on national regulations, properly processed.

#### 2-Serviceing

##### 2-1 Service personnel

- Any person who is involved with working on or breaking into a refrigerant circuit should hold a current valid certificate from an industry-accredited assessment authority, which authorises their competence to handle refrigerants safely in accordance with an industry recognised assessment specification.
- Servicing shall only be performed as recommended by the equipment manufacturer. Maintenance and repair requiring the assistance of other skilled personnel shall be carried out under the supervision of the person competent in the use of flammable refrigerants.
- Servicing shall be performed only as recommended by the manufacturer.

##### 2-2 Work

- Prior to beginning work on systems containing flammable refrigerants, safety checks are necessary to ensure that the risk of ignition is minimized. For repair to the refrigerating system, the precautions in 2-2 to 2-8 shall be complied with prior to conducting work on the system.
- Work shall be undertaken under a controlled procedure so as to minimize the risk of a flammable gas or vapour being present while the work is being performed.
- All maintenance staff and others working in the local area shall be instructed on the nature of work being carried out.
- Work in confined spaces shall be avoided.
- The area around the workspace shall be sectioned off.
- Ensure that the conditions within the area have been made safe by control of flammable material.

##### 2-3 Checking for presence of refrigerant

- The area shall be checked with an appropriate refrigerant detector prior to and during work, to ensure the technician is aware of potentially flammable atmospheres.
- Ensure that the leak detection equipment being used is suitable for use with flammable refrigerants, i.e. nonsparking, adequately sealed or intrinsically safe.

##### 2-4 Presence of fire extinguisher

- If any hot work is to be conducted on the refrigeration equipment or any associated parts, appropriate fire extinguishing equipment shall be available at hand.
- Have a dry powder or CO<sub>2</sub> fire extinguisher adjacent to the charging area.

##### 2-5 No ignition sources

- No person carrying out work in relation to a refrigeration system which involves exposing any pipe work that contains or has contained flammable refrigerant shall use any sources of ignition in such a manner that it may lead to the risk of fire or explosion.
- All possible ignition sources, including cigarette smoking, should be kept sufficiently far away from the site of installation, repairing, removing and disposal, during which flammable refrigerant can possibly be released to the surrounding space.
- Prior to work taking place, the area around the equipment is to be surveyed to make sure that there are no flammable hazards or ignition risks. "No Smoking" signs shall be displayed.

##### 2-6 Ventilated area

- Ensure that the area is in the open or that it is adequately ventilated before breaking into the system or conducting any hot work.
- A degree of ventilation shall continue during the period that the work is carried out.
- The ventilation should safely disperse any released refrigerant and preferably expel it externally into the atmosphere.

### CAUTION

#### 2-7 Checks to the refrigeration equipment

- Where electrical components are being changed, they shall be fit for the purpose and to the correct specification.
- At all times the manufacturer's maintenance and service guidelines shall be followed.
- If in doubt consult the manufacturer's technical department for assistance.
- The following checks shall be applied to installations using flammable refrigerants.
  - The charge size is in accordance with the room size within which the refrigerant containing parts are installed.
  - The ventilation machinery and outlets are operating adequately and are not obstructed.
  - If an indirect refrigerating circuit is being used, the secondary circuit shall be checked for the presence of refrigerant.
  - Marking to the equipment continues to be visible and legible. Markings and signs that are illegible shall be corrected.
  - Refrigeration pipe or components are installed in a position where they are unlikely to be exposed to any substance which may corrode refrigerant containing components, unless the components are constructed of materials which are inherently resistant to being corroded or are suitably protected against being so corroded.

#### 2-8 Checks to electrical devices

- Repair and maintenance to electrical components shall include initial safety checks and component inspection procedures.
- If a fault exists that could compromise safety, then no electrical supply shall be connected to the circuit until it is satisfactorily dealt with.
- If the fault cannot be corrected immediately but it is necessary to continue operation, an adequate temporary solution shall be used.
- This shall be reported to the owner of the equipment so all parties are advised.
- Initial safety checks shall include.
  - That capacitors are discharged: this shall be done in a safe manner to avoid possibility of sparking.
  - That there no live electrical components and wiring are exposed while charging, recovering or purging the system.
  - That there is continuity of earth bonding.

#### 3-Repairs to sealed components

- During repairs to sealed components, all electrical supplies shall be disconnected from the equipment being worked upon prior to any removal of sealed covers, etc.
- If it is absolutely necessary to have an electrical supply to equipment during servicing, then a permanently operating form of leak detection shall be located at the most critical point to warn of a potentially hazardous situation.
- Particular attention shall be paid to the following to ensure that by working on electrical components, the casing is not altered in such a way that the level of protection is affected.
  - This shall include damage to cables, excessive number of connections, terminals not made to original specification, damage to seals, incorrect fitting of glands, etc.
  - Ensure that apparatus is mounted securely.
  - Ensure that seals or sealing materials have not degraded such that they no longer serve the purpose of preventing the ingress of flammable atmospheres.
  - Replacement parts shall be in accordance with the manufacturer's specifications.

NOTE: The use of silicon sealant may inhibit the effectiveness of some types of leak detection equipment.  
Intrinsically safe components do not have to be isolated prior to working on them.

#### 4-Repair to intrinsically safe components

- Do not apply any permanent inductive or capacitance loads to the circuit without ensuring that this will not exceed the permissible voltage and current permitted for the equipment in use.
- Intrinsically safe components are the only types that can be worked on while live in the presence of a flammable atmosphere.
- The test apparatus shall be at the correct rating.
- Replace components only with parts specified by the manufacturer.
- Other parts may result in the ignition of refrigerant in the atmosphere from a leak.

#### 5-Cabling

- Check that cabling will not be subject to wear, corrosion, excessive pressure, vibration, sharp edges or any other adverse environmental effects.
- The check shall also take into account the effects of aging or continual vibration from sources such as compressors or fans.

#### 6-Detection of flammable refrigerants

- Under no circumstances shall potential sources of ignition be used in the searching for or detection of refrigerant leaks.
- A halide torch (or any other detector using a naked flame) shall not be used.

 **CAUTION**

7-Leak detection methods

- Electronic leak detectors shall be used to detect flammable refrigerants, but the sensitivity may not be adequate, or may need re-calibration. (Detection equipment shall be calibrated in a refrigerant-free area.)
- Ensure that the detector is not a potential source of ignition and is suitable for the refrigerant used.
- Leak detection equipment shall be set at a percentage of the LFL of the refrigerant and shall be calibrated to the refrigerant employed and the appropriate percentage of gas (25 % maximum) is confirmed.
- Leak detection fluids are suitable for use with most refrigerants but the use of detergents containing chlorine shall be avoided as the chlorine may react with the refrigerant and corrode the copper pipe-work.
- If a leak is suspected, all naked flames shall be removed/extinguished.
- If a leakage of refrigerant is found which requires brazing, all of the refrigerant shall be recovered from the system, or isolated (by means of shut off valves) in a part of the system remote from the leak.  
Oxygen free nitrogen (OFN) shall then be purged through the system both before and during the brazing process.

8-Removal and evacuation

- When breaking into the refrigerant circuit to make repairs – or for any other purpose –conventional procedures shall be used.  
However, it is important that best practice is followed since flammability is a consideration.  
The following procedure shall be adhered to:
  - remove refrigerant
  - purge the circuit with inert gas
  - evacuate
  - purge again with inert gas
  - open the circuit by cutting or brazing
- The refrigerant charge shall be recovered into the correct recovery cylinders.
- The system shall be “flushed” with OFN to render the unit safe.
- This process may need to be repeated several times.
- Compressed air or oxygen shall not be used for this task.
- Flushing shall be achieved by breaking the vacuum in the system with OFN and continuing to fill until the working pressure is achieved, then venting to atmosphere, and finally pulling down to a vacuum.
- This process shall be repeated until no refrigerant is within the system.
- When the final OFN charge is used, the system shall be vented down to atmospheric pressure to enable work to take place.
- This operation is absolutely vital if brazing operations on the pipe work are to take place.
- Ensure that the outlet for the vacuum pump is not close to any ignition sources and there is ventilation available.

9-Charging procedures

- In addition to conventional charging procedures, the following requirements shall be followed.
  - Ensure that contamination of different refrigerants does not occur when using charging equipment.  
Hoses or lines shall be as short as possible to minimize the amount of refrigerant contained in them.
  - Cylinders shall be kept upright.
  - Ensure that the refrigeration system is earthed prior to charging the system with refrigerant.
  - Label the system when charging is complete (if not already).
  - Extreme care shall be taken not to overfill the refrigeration system.
- Prior to recharging the system it shall be pressure tested with OFN.
- The system shall be leak tested on completion of charging but prior to commissioning.
- A follow up leak test shall be carried out prior to leaving the site.

 **CAUTION**

10-Decommissioning

- Before carrying out this procedure, it is essential that the technician is completely familiar with the equipment and all its details.
- It is recommended good practice that all refrigerants are recovered safely.
- Prior to the task being carried out, an oil and refrigerant sample shall be taken in case analysis is required prior to re-use of reclaimed refrigerant.
- It is essential that electrical power is available before the task is commenced.
  - a) Become familiar with the equipment and its operation.
  - b) Isolate system electrically.
  - c) Before attempting the procedure ensure that:
    - mechanical handling equipment is available, if required, for handling refrigerant cylinders;
    - all personal protective equipment is available and being used correctly;
    - the recovery process is supervised at all times by a competent person;
    - recovery equipment and cylinders conform to the appropriate standards.
  - d) Pump down refrigerant system, if possible.
  - e) If a vacuum is not possible, make a manifold so that refrigerant can be removed from various parts of the system.
  - f) Make sure that cylinder is situated on the scales before recovery takes place.
  - g) Start the recovery machine and operate in accordance with manufacturer’s instructions.
  - h) Do not overfill cylinders. (No more than 80 % volume liquid charge).
  - i) Do not exceed the maximum working pressure of the cylinder, even temporarily.
  - j) When the cylinders have been filled correctly and the process completed, make sure that the cylinders and the equipment are removed from site promptly and all isolation valves on the equipment are closed off.
  - k) Recovered refrigerant shall not be charged into another refrigeration system unless it has been cleaned and checked.





11-Labeling

- Equipment shall be labelled stating that it has been de-commissioned and emptied of refrigerant.
- The label shall be dated and signed.
- Ensure that there are labels on the equipment stating the equipment contains flammable refrigerant.

12-Recovery

- When removing refrigerant from a system, either for servicing or decommissioning, it is recommended good practice that all refrigerants are removed safely.
- When transferring refrigerant into cylinders, ensure that only appropriate refrigerant recovery cylinders are employed.
- Ensure that the correct number of cylinders for holding the total system charge are available.
- All cylinders to be used are designated for the recovered refrigerant and labelled for that refrigerant (i.e. special cylinders for the recovery of refrigerant).
- Cylinders shall be complete with pressure relief valve and associated shut-off valves in good working order.
- Empty recovery cylinders are evacuated and, if possible, cooled before recovery occurs.
- The recovery equipment shall be in good working order with a set of instructions concerning the equipment that is at hand and shall be suitable for the recovery of flammable refrigerants.
- In addition, a set of calibrated weighing scales shall be available and in good working order.
- Hoses shall be complete with leak-free disconnect couplings and in good condition.
- Before using the recovery machine, check that it is in satisfactory working order, has been properly maintained and that any associated electrical components are sealed to prevent ignition in the event of a refrigerant release.  
Consult manufacturer if in doubt.
- The recovered refrigerant shall be returned to the refrigerant supplier in the correct recovery cylinder, and the relevant Waste Transfer Note arranged.
- Do not mix refrigerants in recovery units and especially not in cylinders.
- If compressors or compressor oils are to be removed, ensure that they have been evacuated to an acceptable level to make certain that flammable refrigerant does not remain within the lubricant.
- The evacuation process shall be carried out prior to returning the compressor to the suppliers.
- Only electric heating to the compressor body shall be employed to accelerate this process.
- When oil is drained from a system, it shall be carried out safely.

Explanation of symbols displayed on the indoor unit or outdoor unit.

	<b>WARNING</b>	This symbol shows that this appliance uses a flammable refrigerant. If the refrigerant is leaked and exposed to an external ignition source, there is a risk of fire.
	<b>CAUTION</b>	This symbol shows that the operation manual should be read carefully.
	<b>CAUTION</b>	This symbol shows that a service personnel should be handling this equipment with reference to the installation manual.
	<b>CAUTION</b>	This symbol shows that information is available such as the operating manual or installation manual.

## 2. PRODUCT SPECIFICATION

### 2.1. Special tools for R32 (R410A)

Tool name	Change from R22 to R32 (R410A)
Gauge manifold	Pressure is high and cannot be measured with a R22 gauge. To prevent erroneous mixing of other refrigerants, the diameter of each port has been changed. It is recommended to use gauge with seals -0.1 to 5.3 MPa (-1 to 53 bar) for high pressure. -0.1 to 3.8 MPa (-1 to 38 bar) for low pressure.
Charge hose	To increase pressure resistance, the hose material and base size were changed. (R32/R410A)
Vacuum pump	A conventional vacuum pump can be used by installing a vacuum pump adaptor. (Use of a vacuum pump with a series motor is prohibited.)
Gas leakage detector	Special gas leakage detector for HFC refrigerant R410A or R32.

#### Copper pipes

It is necessary to use seamless copper pipes and it is desirable that the amount of residual oil is less than 40 mg/10 m. Do not use copper pipes having a collapsed, deformed or discolored portion (especially on the interior surface). Otherwise, the expansion valve or capillary tube may become blocked with contaminants.

As an air conditioner using R32 (R410A) incurs pressure higher than when using R22, it is necessary to choose adequate materials.









#### ⚠ WARNING

- Do not use the existing (for R22) piping and flare nuts. If the existing materials are used, the pressure inside the refrigerant cycle will rise and cause failure, injury, etc. (Use the special R32/R410A materials.)
- Use (refill or replace with) specified refrigerant (R32) only. Use of unspecified refrigerant can cause product malfunction, burst, or injury.
- Do not mix any gas or impurities except specified refrigerant (R32). Inflow of air or application of unspecified material makes the internal pressure of the refrigerant cycle too high, and may cause product malfunction, burst of piping, or injury.
- For installation purposes, be sure to use the parts supplied by the manufacturer or other prescribed parts. The use of non-prescribed parts can cause serious accidents such as the unit falling, water leakage, electric shock, or fire.
- Do not turn on the power until all work has been completed.
- Do not use a vacuum pump or refrigerant recovery tools with a series motor, since it may ignite. (for outdoor unit)

### 2.2. Accessories

- The following installation parts are supplied. Use them as required.
- Keep the Installation Manual in a safe place and do not discard any other accessories until the installation work has been completed.

#### ■ For indoor unit

Name and Shape	Q'ty	Name and Shape	Q'ty
Operating Manual 	1	Cloth tape 	1
Operating Manual (CD-ROM) 	1	Tapping screws 	5
Installation Manual (This manual) 	1	Battery 	2
Remote controller 	1	Wall hook bracket 	1

#### ■ For outdoor unit

Name and shape	Q'ty	Description
Drain pipe 	1	For outdoor unit drain piping work (May not be supplied, depending on the model.)

The following items are necessary to install this air conditioner. (The items are not included with the air conditioner and must be purchased separately.)

Additional materials	
Connection pipe assembly	Wall cap
Connection cable (4-conductor)	Saddle
Wall pipe	Drain hose
Decorative tape	Tapping screws
Vinyl tape	Putty

### 2.3. General specification

#### 2.3.1. Selecting the pipe material

#### ⚠ CAUTION

- Use pipes that have clean external and internal sides without any contamination which may cause trouble during use, such as sulfur, oxide, dust, cutting waste, oil, or water.
- It is necessary to use seamless copper pipes. Material: Phosphor deoxidized seamless copper pipes. It is desirable that the amount of residual oil is less than 40 mg/10 m.
- Improper pipe selection will degrade performance. As an air conditioner using R32(R410A) incurs pressure higher than when using conventional refrigerant, it is necessary to choose adequate materials.

- Thicknesses of copper pipes used with R32(R410A) are as shown in the table.
- Never use copper pipes thinner than those indicated in the table even if they are available on the market.

#### Thicknesses of Annealed Copper Pipes

Pipe outside diameter [mm (in.)]	Thickness [mm]
6.35 (1/4)	0.80
9.52 (3/8)	0.80

#### 2.3.2. Protection of pipes

- Protect the pipes to prevent the entry of moisture and dust.
- Especially, pay attention when passing the pipes through a hole or connecting the end of a pipe to the outdoor unit.

Location	Working period	Protection method
Outdoor	1 month or more	Pinch pipes
	Less than 1 month	Pinch or tape pipes
Indoor	-	Pinch or tape pipes

#### 2.3.3. Refrigerant pipe size and allowable piping length

#### ⚠ CAUTION

- Keep the piping length between the indoor unit and outdoor unit within the allowable tolerance.
- The maximum lengths of this product are shown in the table. If the units are further apart than this, correct operation cannot be guaranteed.

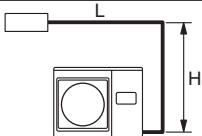
Model	KP series
Pipe diameter <Liquid/Gas> [mm (in.)]	6,35 (1/4) /9,52 (3/8)
Max. piping length (L) [m]	20
Max. height difference (H) <Indoor unit to outdoor unit> [m]	15
View (Example)	

#### ⚠ CAUTION

- Wrap heat insulation around both gas pipe and liquid pipe. No heat-insulation work or incorrect heat-insulation work may cause water leaks.
- In a reverse cycle model, use heat insulation with heat resistance above 120 °C.
- If expected humidity of the installation location of refrigerant pipes is higher than 70 %, wrap the heat insulation around the refrigerant pipes. If the expected humidity is between 70 % and 80 %, use heat insulation that has a thickness of 15 mm or more. If the expected humidity is higher than 80 %, use heat insulation that has a thickness of 20 mm or more.
- The use of thinner heat insulation than specified above, may cause a condensation on the surface of the insulation.
- Use heat insulation with thermal conductivity of 0.045 W/(m·K) or less, at 20 °C.

## 2.4. Electrical requirement

The indoor unit is powered from the outdoor unit. Do not power indoor unit from separate power source.

### ⚠ WARNING

- Standard for electrical wiring and equipment differs in each country or region. Before you start electrical working, confirm related regulations, codes, or standards.
- Be sure to install a breaker of the specified capacity (for outdoor unit).

<b>Voltage rating</b>	1 $\Phi$ 230 V (50 Hz)
<b>Operating range</b>	198 to 264 V

Cable	Conductor size [mm <sup>2</sup> ] <sup>*1</sup>	Type	Remarks
Power Supply Cable	1.5	Type60245 IEC57	2 wire + Ground 1 $\Phi$ 230 V
Connection Cable	1.5	Type60245 IEC57	3 wire + Ground 1 $\Phi$ 230 V

\*1 Selected sample: Select the correct cable type and size according to the country or region's regulations.

\* Limit the voltage drop less than 2 %. Increase the cable diameter if voltage drop is 2 % or more.

Model	Breaker capacity [A]	Earth leakage breaker [mA]
KP series	15	30

- Select the breaker that enough load current can pass through it.
- Before starting work check that power is not being supplied to all poles of the indoor unit and outdoor unit.
- Install all electrical works in accordance to standard.
- Install the disconnect device with a contact gap of at least 3 mm in all poles nearby the units. (Both indoor unit and outdoor unit)

## 2.5. Optional parts

Refer to each installation manual for the method of installing optional parts.

Parts name	Model No.	Application
Remote controller holder	UTZ-RXLA	For storing wireless remote controller
WLAN adapter	UTY-TFSXF2	For wireless LAN control

## 2.6. Additional charge

### ⚠ CAUTION

When adding refrigerant, add the refrigerant from the charging port at the completion of work.

Refrigerant suitable for a piping length of 15 m is charged in the outdoor unit at the factory. When the piping is longer than 15 m, additional charging is necessary. For the additional amount, refer to the following table.

Pipe length	15 m	20 m	Rate
Additional refrigerant	None	+100 g	20 g/m

Between 15 m and the maximum length, when using a connection pipe other than that in the table, charge additional refrigerant with 20 g/1 m as the criteria.

## 4. INSTALLATION WORK

[For indoor unit]

### 4.1. Selecting the mounting position

Decide the mounting position with the customer as follows:

- (1) Install the indoor unit level on a strong wall which is not subject to vibration.
- (2) The inlet and outlet ports should not be obstructed: the air should be able to blow all over the room.
- (3) Install the unit a dedicated electrical branch circuit.
- (4) Do not install the unit where it will be exposed to direct sunlight.
- (5) Install the unit where connection to the outdoor unit is easy.
- (6) Install the unit where the drain pipe can be easily installed.
- (7) Take servicing, etc. into consideration and leave the spaces shown in "4.2. Installation dimensions". Also install the unit where the filter can be removed.

Correct initial installation location is important because it is difficult to move the unit after it is installed.

### ⚠ WARNING

Install the indoor unit where is capable to support the weight of the unit. Secure the unit firmly so that the unit does not topple or fall.

### ⚠ CAUTION

Do not install the unit in the following areas:

- Area with high salt content, such as at the seaside. It will deteriorate metal parts, causing the parts to fail or the unit to leak water.
- Area filled with mineral oil or containing a large amount of splashed oil or steam, such as a kitchen. It will deteriorate plastic parts, causing the parts to fail or the unit to leak water.
- Area where is close to heat sources.
- Area that generates substances that adversely affect the equipment, such as sulfuric gas, chlorine gas, acid, or alkali. It will cause the copper pipes and brazed joints to corrode, which can cause refrigerant leakage.
- Area that can cause combustible gas to leak, contains suspended carbon fibers or flammable dust, or volatile in flammables such as paint thinner or gasoline.
- If gas leaks and settles around the unit, it can cause a fire.
- Area where animals may urinate on the unit or ammonia may be generated.
- Do not use the unit for special purposes, such as storing food, raising animals, growing plants, or preserving precision devices or art objects. It can degrade the quality of the preserved or stored objects.
- Install the unit where drainage does not cause any trouble.
- Install the indoor unit, outdoor unit, power supply cable, transmission cable, and remote control cable at least 1 m away from a television or radio receivers. The purpose of this is to prevent TV reception interference or radio noise.  
(Even if they are installed more than 1 m apart, you could still receive noise under some signal conditions.)
- If children under 10 years old may approach the unit, take preventive measures so that they cannot reach the unit.
- Install the indoor unit on the wall where the height from the floor is more than 1.8 m.

### 4.2. Installation dimensions

### ⚠ WARNING

During transportation or relocation of the indoor unit, pipes shall be covered with the wall hook bracket for protection. Do not move the appliance by holding the indoor unit pipes.  
(The stress applied to the pipe joints may cause the flammable gas to leak during operation.)

Keep the distance between the wall hook bracket or indoor unit to the surrounding walls as indicated in the following figure.

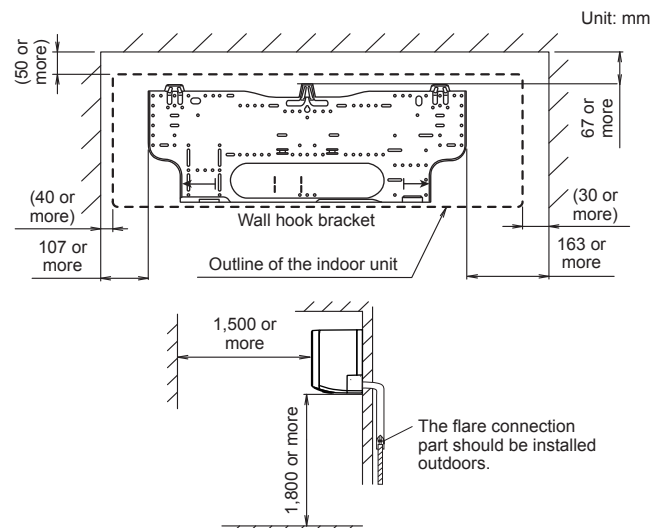

### 4.3. Indoor unit piping direction

The piping can be connected in 2 directions. When the piping is connected in direction (B), cut out a hole in the under cover along the piping groove with a hacksaw.

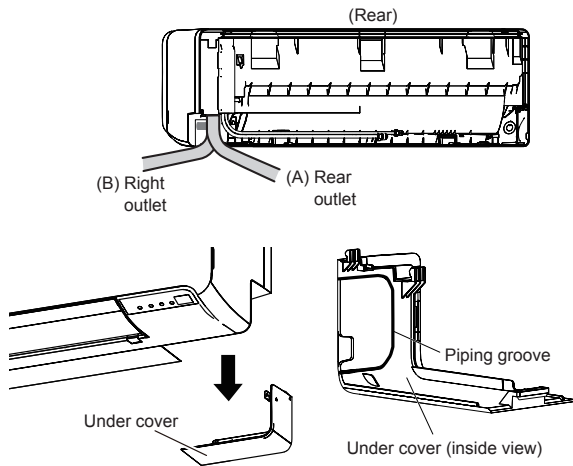

### 4.4. Cutting the hole in the wall for connecting the pipes

- Cut a 65 mm diameter hole in the wall at the position shown in the following.
- Cut the hole so that the outside end is lower (5 to 10 mm) than the inside end.
- Always align the center of the wall hole. If misaligned, water leakage will occur.
- Cut the wall pipe to match the wall thickness, stick it into the wall cap, fasten the cap with vinyl tape, and stick the pipe through the hole.
- For the right piping, cut the hole a little lower so that drain water will flow freely.

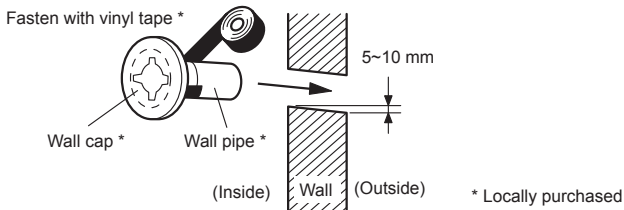
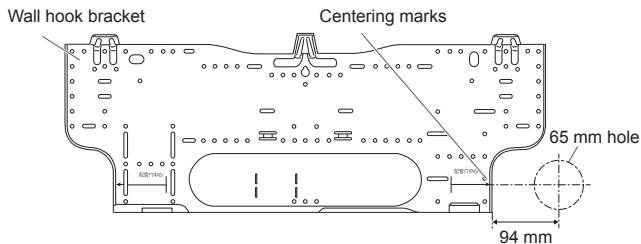

### WARNING

Always use the wall pipe. If the wall pipe is not used, the cable that is connected between the indoor unit and the outdoor unit may touch metal, and cause an electric discharge.

### 4.5. Installing the wall hook bracket

- Install the wall hook bracket so that it is correctly positioned horizontally and vertically. If the wall hook bracket is tilted, water will drip to the floor.
- Install the wall hook bracket so that it is strong enough to support the weight of the unit.
  - Fasten the wall hook bracket to the wall with 5 or more screws through the holes near the outer edge of the bracket.
  - Check that there is no rattle at the wall hook bracket.

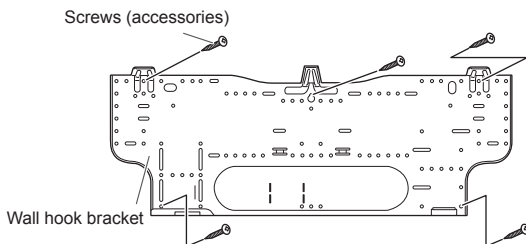

### CAUTION

Install the wall-hook bracket both horizontally and vertically aligned. Misaligned installation may cause water leakage.

### 4.6. Forming the drain hose and pipe

### CAUTION

- Insert drain hose and drain cap securely. Drain should slope down to avoid water leakage.
- When inserting the drain hose, no other material than water should be applied. Application of other material than water will cause deterioration of the hose, and may cause water leakage.
- After you remove a drain hose, be sure to attach the drain cap.
- When you secure the piping and drain hose with tape, arrange the drain hose so that it is at the bottom of the piping.
- For drain hose piping in low temperature environment, you need to apply freeze protection to prevent a frozen drain hose. After cooling operation is performed in low temperature environment (when outdoor temperature under 0 °C), water in the drain hose could be frozen. Frozen drain water will block the water flow in the hose, and may cause water leakage at the indoor unit.

#### [Rear piping, Right piping]

- Install the indoor unit piping in the direction of the wall hole and bind the drain hose and pipe together with vinyl tape.
- Install the piping so that the drain hose is at the bottom.
- Wrap the pipes of the indoor unit that are visible from the outside with decorative tape.

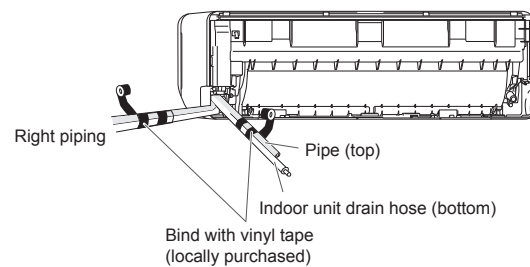

### CAUTION

Insert the drain hose and drain cap into the drain port, making sure that it comes in contact with the back of the drain port, and then mount it. If the drain hose is not connected properly, leaking will occur.

#### [Installing the indoor unit]

- Hang the indoor unit from the hooks at the top of the wall hook bracket.
- Insert the spacer, etc. between the indoor unit and the wall hook bracket and separate the bottom of the indoor unit from the wall.

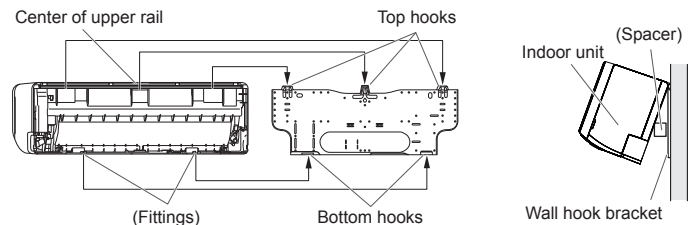

- After hooking the indoor unit to the top hook, hook the fittings of the indoor unit to the bottom hooks while lowering the unit and pushing it against the wall.

### 4.7. Pipe connection

### CAUTION

Tighten the flare nuts with a torque wrench using the specified tightening method. Otherwise, the flare nuts could break after a prolonged period, causing refrigerant to leak and generate hazardous gas if the refrigerant comes into contact with a flame.

#### 4.7.1. Flaring

Use special pipe cutter and flare tool designed for R410A or R32 pipework.

- Cut the connection pipe to the necessary length with a pipe cutter.
- Hold the pipe downward so that cuttings will not enter the pipe and remove any burrs.
- Insert the flare nut (always use the flare nut attached to the indoor unit(s) and outdoor unit or branch box respectively) onto the pipe and perform the flare processing with a flare tool. Use the special R410A or R32 flare tool, or the conventional flare tool. Leakage of refrigerant may result if other flare nuts are used.
- Protect the pipes by pinching them or with tape to prevent dust, dirt, or water from entering the pipes.

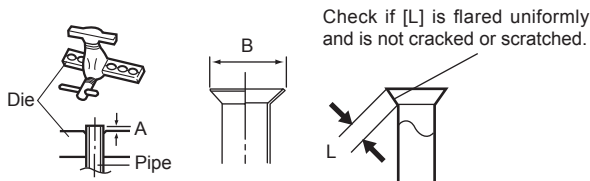

Pipe outside diameter [mm (in.)]	Dimension A [mm]	Dimension B [mm]
	Flare tool for R32, clutch type	
6.35 (1/4)	0 to 0.5	9.1
9.52 (3/8)		13.2

When using conventional flare tools to flare R32 pipes, the dimension A should be approximately 0.5 mm more than indicated in the table (for flaring with R32 flare tools) to achieve the specified flaring. Use a thickness gauge to measure the dimension A.

Pipe outside diameter [mm (in.)]	Width across flats of Flare nut [mm]
6.35 (1/4)	17
9.52 (3/8)	22

#### 4.7.2. Bending pipes

##### CAUTION

- To prevent breaking of the pipe, avoid sharp bends.
- If the pipe is bent repeatedly at the same place, it will break.

- The pipes are shaped by your hands. Be careful not to collapse them.
- Bend R70 mm or more with a pipe bender.
- Do not bend the pipes in an angle more than 90°.
- When pipes are repeatedly bent or stretched, the material will harden, making it difficult to bend or stretch them anymore.
- Do not bend or stretch the pipes more than 3 times.
- When bending the pipe, do not bend it as is. The pipe will be collapsed. In this case, cut the insulating pipe with a sharp cutter as shown on the right, and bend it after exposing the pipe. After bending the pipe as you want, be sure to put the heat insulating pipe back on the pipe, and secure it with tape.

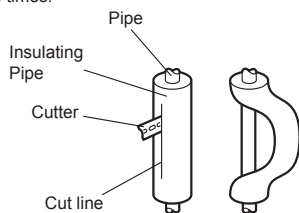

#### 4.7.3. Flare connection

##### WARNING

The flare connection shall not be performed indoors.

##### CAUTION

- Be sure to install the pipe against the port on the indoor unit correctly. If the centering is improper, the flare nut cannot be tightened smoothly. If the flare nut is forced to turn, the threads will be damaged.
- Do not remove the flare nut from the indoor unit pipe until immediately before connecting the connection pipe.
- Hold the torque wrench at its grip, keeping it in the right angle with the pipe, in order to tighten the flare nut correctly.
- Tighten the flare nuts with a torque wrench using the specified tightening method. Otherwise, the flare nuts could break after a prolonged period, causing refrigerant to leak and generate hazardous gas if the refrigerant comes into contact with a flame.
- Connect the piping so that the control box cover can easily be removed for servicing when necessary.
- In order to prevent water from leaking into the control box, make sure that the piping is well insulated.

When the flare nut is tightened properly by your hand, hold the body side coupling with a wrench, then tighten with a torque wrench. (See the following table for the flare nut tightening torques.)

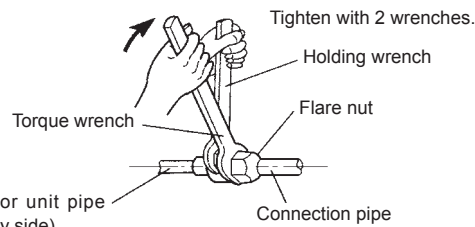

Flare nut [mm (in.)]	Tightening torque [N·m (kgf·cm)]
6.35 (1/4) dia.	16 to 18 (160 to 180)
9.52 (3/8) dia.	32 to 42 (320 to 420)

Do not remove the cap from the connection pipe before connecting the pipe.

## 5. ELECTRICAL WIRING

[For indoor unit]

### WARNING

- Before connecting the wires, make sure the power supply is OFF.
- Every wire must be connected firmly.
- No wire should be allowed to touch refrigerant tubing, the compressor, or any moving part.
- Loose wiring may cause the terminal to overheat or result in unit malfunction. A fire hazard may also exist. Therefore, be sure all wiring is tightly connected.
- Connect wires to the matching numbers of terminals.

### CAUTION

- Be careful not to generate a spark as follows for using a flammable refrigerant.
- Do not remove the fuse while the power is on.
  - Do not disconnect the wiring while the power is on.
  - It is recommended to position the outlet connection in a high position. Place the cords so that they do not get tangled.

### 5.1. Wiring system diagram

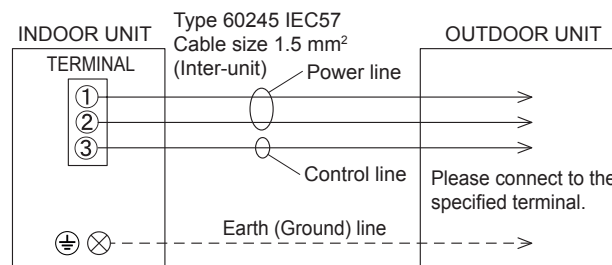

### 5.2. Indoor unit wiring

- Remove the intake grille. (Refer to "6.1. Intake grille removal and installation".)
- Remove the tapping screw for the wire cover and the wire cover. (Wire covers A and B come off together.)

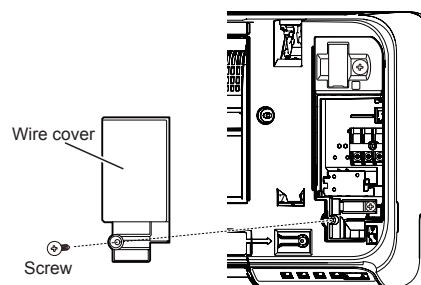

- (3) Remove the tapping screw and while minding the cable clamp hook, remove the cable clamp.

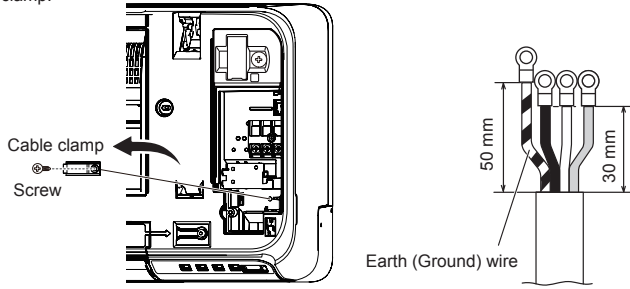

### 5.3. How to connect wiring to the terminals

#### Caution when wiring cable

To strip off the insulation of a lead wire, always use a special tool such as a wire stripper. If there is no special tool, carefully strip off the insulation by using a knife or other utensil.

- Use ring terminals with insulating sleeves as shown in the figure to connect to the terminal block.
- Securely clamp the ring terminals to the wires by using an appropriate tool so that the wires do not come loose.

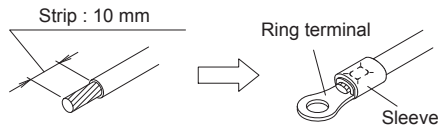

- Connect specified wires securely, and fasten them so that there is no stress applied on the terminals.
- Use a screwdriver with an appropriate bit size to tighten the terminal screws. Using of screwdriver with inappropriate bit size will damage the screw heads, and the screws will not be tightened properly.
- Do not overtighten the terminal screws. Otherwise, the screws may break.

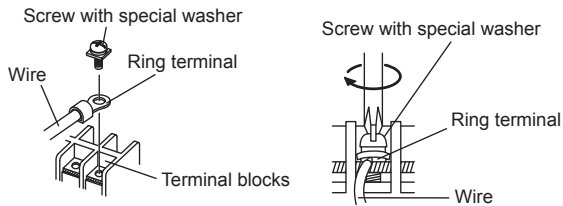

- (6) See the table for the terminal screw tightening torques.

Tightening torque [N·m (kgf·cm)]	
M3.5 screw	0.8 to 1.0 (8 to 10)
M4 screw	1.2 to 1.8 (12 to 18)
M5 screw	2.0 to 3.0 (20 to 30)

#### CAUTION

- Match the terminal block numbers and connection cable colors with those of the outdoor unit. Incorrect wiring may cause a fire.
- Connect the connection cables firmly to the terminal block. Imperfect installation may cause a fire.
- When fixing the connection cable with the cable clamp, always fasten the cable at the plastic jacket portion, but not at the insulator portion. If the insulator is chafed, electric leakage may occur.
- Always connect the earth (ground) wire. Improper earthing (grounding) work can cause electric shocks.
- Do not use the earth (ground) screw for the indoor unit to the outdoor unit unless it is specified.

## 6. REMOVING AND REPLACING PARTS

[For indoor unit]

### 6.1. Intake grille removal and installation

#### Intake grille removal

- (1) Hold the intake grille with both hands at the side, then pull to the front until it becomes hooked.

- (2) Keeping the intake grille in a horizontal position, pull the mounting shaft on the left and right to release.

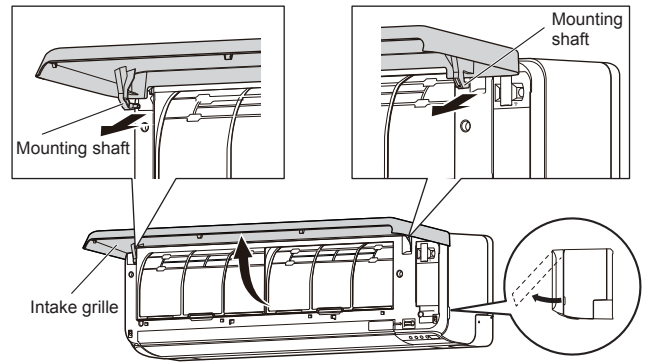

#### Intake grille installation

- (1) Attach the left and right mounting shaft in the direction of the arrow to the panel top bearing while supporting the intake grille horizontally. Press this until it clicks so that each shaft snaps into place.

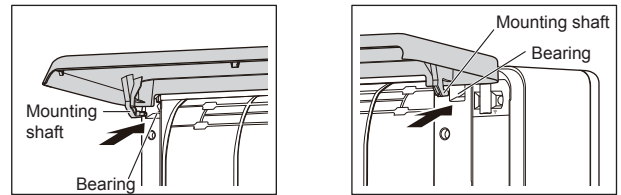

- (2) Press and close the intake grille.

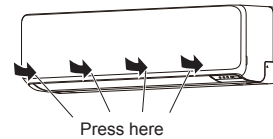

### 6.2. Front panel / control cover removal and installation

\* In this description, the intake grille and wire cover already has been removed.

#### 6.2.1. Front panel / control cover / under cover removal

- Remove the under covers. (Press down on the markings on the side, then slide down.)
- Remove the screw covers (2 places) on the bottom of the front panel, and then remove the screws (4 places).
- Push down on the markings (2 places) on top of the front panel to release the hooks (3 places), then pull the front panel towards you.
- Pinch the tab on the control cover to release the hook, then open.

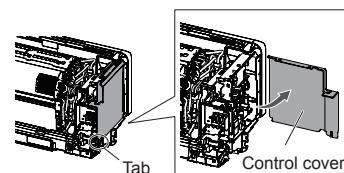
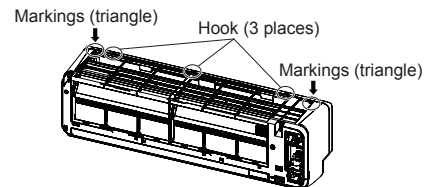
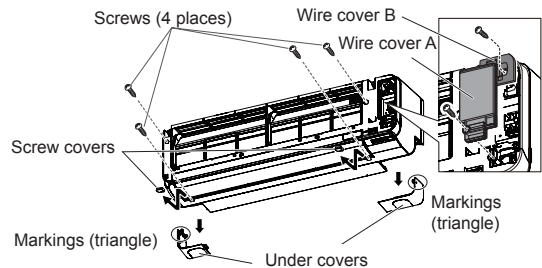



### 6.2.2. Front panel / control cover / under cover installation

Reverse the procedures in "6.2.1. Front panel / control cover / under cover removal".  
\* Be sure to replace the screws (4 places) and screw cover (2 places).

#### CAUTION

Please take caution when removing or installing the front panel. If the front panel falls, there is a risk of injury.

### 6.3. Uninstalling the indoor unit

Remove the indoor unit from the wall hook bracket as follows.

- (1) Remove the under covers. (See "6.2.1. Front panel / control cover / under cover removal".)
- (2) Insert your fingers in the opening shown in the figure. While pushing down on the lower part of the opening, release the hooks (2 places).
- (3) Pull the indoor unit towards you.

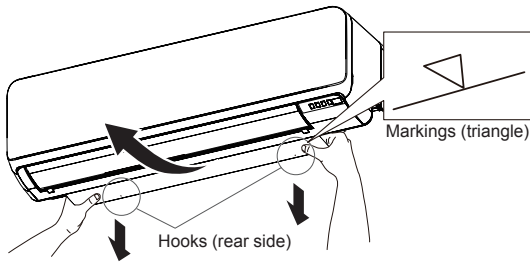

### 7. REMOTE CONTROLLER INSTALLATION

[For indoor unit]

Check that the indoor unit correctly receives the signal from the remote controller, then install the remote controller holder.

#### CAUTION

Do not install the remote controller holder in the following conditions:

- Any places exposed in direct sunlight
- Positions affected by the heat from a stove or heater

#### 7.1. Remote controller holder installation (optional part)

- Install the remote controller a maximum distance of 7 m from the remote control signal receiver. After installing the remote controller, check that it operates correctly.
- Install the remote controller holder to a wall, pillar, etc. with the tapping screw.

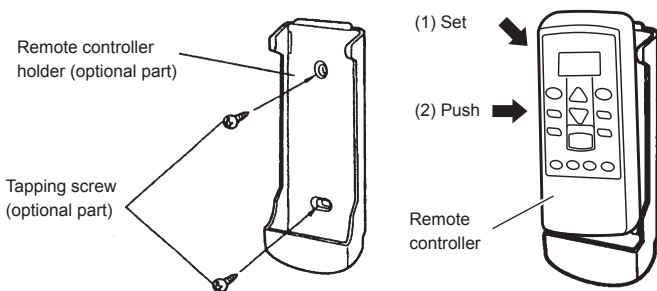

#### 7.2. Remote controller custom setting

Use the following steps to select the custom code of the remote controller.  
(Note that the air conditioner cannot receive a signal if the air conditioner has not been set for the matching custom code.)

- (1) Press [START/STOP] until the remote controller display is turned off.
- (2) Press [MODE] for at least five seconds to display the current custom code (initially set to A).
- (3) Press [SET TEMP. (▲ / ▼)] to change the custom code between A ↔ b ↔ C ↔ d.  
Match the code on the display to the air conditioner custom code.
- (4) Press [MODE] again and the display will be turned off. The custom code will be changed.

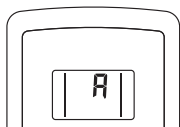

#### NOTES:

- If no buttons are pressed within 30 seconds after the custom code is displayed, the system returns to the original display. In this case, start again from step 1.
- Depending on the remote controller, the custom code may return to custom code A when the batteries are replaced. In this case, if you use a code other than A, reset the code after replacing the batteries. If you do not know the air conditioner custom code setting, try each code (A→B→C→D) until you find the code which operates the air conditioner.

### 8. FUNCTION SETTING

[For indoor unit]

Perform the Function Setting according to the installation conditions using the remote controller.

#### CAUTION

- Confirm whether the wiring work for outdoor unit has been finished.
- Confirm that the cover for the electrical enclosure on the outdoor unit is in place.

#### Entering the function setting mode

While pressing [FAN] and [SET TEMP. (▲)] simultaneously, press [RESET] to enter the function setting mode.

#### STEP 1

##### Setting the remote controller custom code

Use the following steps to select the custom code of the remote controller. (Note that the air conditioner cannot receive a custom code if the air conditioner has not been set for the custom code.) The custom code that is set through this process are applicable only to the custom in the function setting.

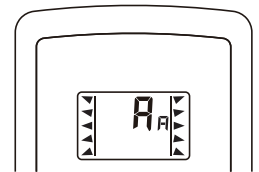

- (1) Press [SET TEMP.(▲ / ▼)] to change the custom code between A → b → C → d. Match the code on the display to the air conditioner custom code. (initially set to A) (If the custom code does not need to be selected, press [MODE] and proceed to STEP 2.)
- (2) Press [MODE] to accept the custom code, and proceed to STEP 2

The air conditioner custom code is set to A prior to shipment. Contact your retailer to change the custom code.

The remote controller resets to custom code A when the batteries in the remote controller are replaced. If you use a custom code other than custom code A, reset the custom code after replacing the batteries. If you do not know the air conditioner custom code setting, try each of the custom codes (A → b → C → d) until you find the code which operates the air conditioner.

#### STEP 2

##### Setting the function number and setting value

- (1) Press [SET TEMP. (▲ / ▼)] to select the function number. (Press [MODE] to switch between the left and right digits.)
- (2) Press [FAN] to proceed to setting the value. (Press [FAN] again to return to the function number selection.)
- (3) Press [SET TEMP. (▲ / ▼)] to select the setting value. (Press [MODE] to switch between the left and right digits.)
- (4) Press [SLEEP], then after you hear the beep emitted from the indoor unit, press [START/STOP] to confirm the settings.
- (5) Press [RESET] to cancel the function setting mode.
- (6) After completing the function setting, be sure to disconnect the power supply and then reconnect it.

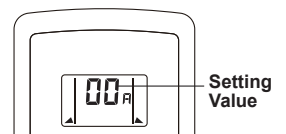
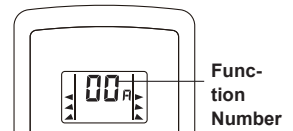

#### CAUTION

After disconnecting the power supply, wait 30 seconds or more before reconnecting it. The Function Setting will not become active unless the power supply is disconnected and then reconnected.

## 8.1. Function Details

### Filter sign

Select appropriate intervals for displaying the filter sign on the indoor unit according to the estimated amount of dust in the air of the room.

If the indication is not required, select "No indication" (03).

(◆... Factory setting)

Function Number	Setting Value	Setting Description
11	00	Standard (400 hours)
	01	Long interval (1000 hours)
	02	Short interval (200 hours)
	03	No indication

### Room temperature control for indoor unit sensor

Depending on the installed environment, correction of the room temperature sensor may be required.

Select the appropriate control setting according to the installed environment.

The temperature correction values show the difference from the "Standard setting" (00) (manufacturer's recommended value).

(◆... Factory setting)

Function Number	Setting Value	Setting Description	
30 (For cooling)	31 (For heating)	00	Standard setting
		01	No correction 0.0 °C (0 °F)
		02	-0.5 °C (-1 °F)
		03	-1.0 °C (-2 °F)
		04	-1.5 °C (-3 °F)
		05	-2.0 °C (-4 °F)
		06	-2.5 °C (-5 °F)
		07	-3.0 °C (-6 °F)
	08	-3.5 °C (-7 °F)	
	09	-4.0 °C (-8 °F)	
	10	+0.5 °C (+1 °F)	
	11	+1.0 °C (+2 °F)	
	12	+1.5 °C (+3 °F)	
	13	+2.0 °C (+4 °F)	
	14	+2.5 °C (+5 °F)	
	15	+3.0 °C (+6 °F)	
	16	+3.5 °C (+7 °F)	
17	+4.0 °C (+8 °F)		

More Cooling  
Less Heating

Less Cooling  
More Heating

### Auto restart

Enable or disable automatic restart after a power interruption.

(◆... Factory setting)

Function Number	Setting Value	Setting Description
40	00	Enable
	01	Disable

\* Auto restart is an emergency function such as for power outage etc. Do not attempt to use this function in normal operation. Be sure to operate the unit by remote controller or external device.

### Room temperature sensor switching

(Only for wireless remote controller)

When using the Wired remote controller temperature sensor, change the setting to "Both" (01).

(◆... Factory setting)

Function Number	Setting Value	Setting Description
42	00	Indoor unit
	01	Both

00: Sensor on the indoor unit is active.

01: Sensors on both indoor unit and wired remote controller are active.

\* Remote controller sensor must be turned on by using the remote controller

### Remote controller custom code

(Only for wireless remote controller)

The indoor unit custom code can be changed. Select the appropriate custom code.

(◆... Factory setting)

Function Number	Setting Value	Setting Description
44	00	A
	01	B
	02	C
	03	D

### External input control

"Operation/Stop" mode or "Forced stop" mode can be selected.

(◆... Factory setting)

Function Number	Setting Value	Setting Description
46	00	Operation/Stop mode 1
	01	(Setting prohibited)
	02	Forced stop mode
	03	Operation/Stop mode 2

### Room temperature sensor switching (Aux.)

To use the temperature sensor on the wired remote controller only, change the setting to "Wired remote controller" (01). This function will only work if the function setting 42 is set at "Both" (01)

(◆... Factory setting)

Function Number	Setting Value	Setting Description
48	00	Both
	01	Wired remote controller

### Indoor unit fan control for energy saving for cooling

Enables or disables the power-saving function by controlling the indoor unit fan rotation when the outdoor unit is stopped during cooling operation.

(◆... Factory setting)

Function Number	Setting Value	Setting description
49	00	Disable
	01	Enable
	02	Remote controller

00: When the outdoor unit is stopped, the indoor unit fan operates continuously following the setting on the remote controller.

01: When the outdoor unit is stopped, the indoor unit fan operates intermittently at a very low speed.

02: Enable or disable this function by remote controller setting.

\*When using a wired remote controller without Indoor unit fan control for energy saving for cooling function, or when connecting a single split converter, the setting cannot be made by using the remote controller. Set to (00) or (01).

To confirm if the remote controller has this function, refer to the operating manual of each remote controller.

### Setting record

Record any changes to the settings in the following table.

Setting Description	Setting Value
Filter sign	
Room temperature control for indoor unit sensor	Cooling Heating
Auto restart	
Room temperature sensor switching	
Remote controller custom code	
External input control	
Room temperature sensor switching (Aux.)	
Indoor unit fan control for energy saving for cooling	

After completing the Function Setting, be sure to disconnect the power supply and then reconnect it.

## 9. OPTIONAL KIT INSTALLATION

[For indoor unit]

### 9.1. Installing the WLAN adapter

#### NOTES:

For installing the W-LAN adapter, refer to the operating manual.

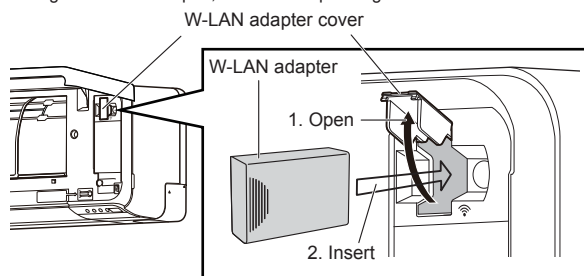

## 10. INSTALLATION WORK

[For outdoor unit]

Make sure to obtain the customer's approval for selecting and installing the outdoor unit.

### 10.1. Selecting an installation location

#### WARNING

- Securely install the outdoor unit at a location that can withstand the weight of the unit. Otherwise, the outdoor unit may fall and cause injury.
- Be sure to install the outdoor unit as prescribed, so that it can withstand earthquakes and typhoons or other strong winds. Improper installation can cause the unit to topple or fall, or other accidents.
- Do not install the outdoor unit near the edge of a balcony. Otherwise, children may climb onto the outdoor unit and fall off of the balcony.

#### CAUTION

- Do not install the outdoor unit in the following areas:
  - Area with high salt content, such as at the seaside. It will deteriorate metal parts, causing the parts to fail or the unit to leak water.
  - Area filled with mineral oil or containing a large amount of splashed oil or steam, such as a kitchen. It will deteriorate plastic parts, causing the parts to fail or the unit to leak water.
  - Area that generates substances that adversely affect the equipment, such as sulfuric gas, chlorine gas, acid, or alkali. It will cause the copper pipes and brazed joints to corrode, which can cause refrigerant leakage.
  - Area containing equipment that generates electromagnetic interference. It will cause the control system to malfunction, preventing the unit from operating normally.
  - Area that can cause combustible gas to leak, contains suspended carbon fibers or flammable dust, or volatile inflammables such as paint thinner or gasoline. If gas leaks and settles around the unit, it can cause a fire.
  - Area that has heat sources, vapors, or the risk of the leakage of flammable gas in the vicinity.
  - Area where small animals may live. It may cause failure, smoke or fire if small animals enter and touch internal electrical parts.
  - Area where animals may urinate on the unit or ammonia may be generated.
- Do not tilt the outdoor unit more than 3 degrees. However, do not install the unit with it tilted towards the side containing the compressor.
- Install the outdoor unit in a well-ventilated location away from rain or direct sunlight.
- If the outdoor unit must be installed in an area within easy reach of the general public, install as necessary a protective fence or the like to prevent their access.
- Install the outdoor unit in a location that would not inconvenience your neighbors, as they could be affected by the airflow coming out from the outlet, noise, or vibration. If it must be installed in proximity to your neighbors, be sure to obtain their approval.
- If the outdoor unit is installed in a cold region that is affected by snow accumulation, snow fall, or freezing, take appropriate measures to protect it from those elements. To ensure a stable operation, install inlet and outlet ducts.

#### CAUTION

- Install the outdoor unit in a location that is away from exhaust or the vent ports that discharge vapor, soot, dust, or debris.
- Install the indoor unit, outdoor unit, power supply cable, connection cable, and remote controller cable at least 1 m away from a television or radio receivers. The purpose of this is to prevent TV reception interference or radio noise. (Even if they are installed more than 1 m apart, you could still receive noise under some signal conditions.)
- If children under 10 years old may approach the unit, take preventive measures so that they cannot reach the unit.
- Keep the length of the piping of the indoor and outdoor units within the allowable range.
- For maintenance purposes, do not bury the piping.

Decide the mounting position with the customer as follows:

- (1) Install the outdoor unit in a location which can withstand the weight of the unit and vibration, and which can install horizontally.
- (2) Provide the indicated space to ensure good airflow.
- (3) If possible, do not install the unit where it will be exposed to direct sunlight. (If necessary, install a blind that does not interfere with the airflow.)
- (4) Do not install the unit near a source of heat, steam, or flammable gas.
- (5) During heating operation, drain water flows from the outdoor unit. Therefore, install the outdoor unit in a place where the drain water flow will not be obstructed.
- (6) Do not install the unit where strong wind blows or where it is very dusty.
- (7) Do not install the unit where people pass.
- (8) Install the outdoor unit in a place where it will be free from being dirty or getting wet by rain as much as possible.
- (9) Install the unit where connection to the indoor unit is easy.

### 10.2. Drain installation

#### CAUTION

- Perform drain work in accordance with this Manual, and ensure that the drain water is properly drained. If the drain work is not carried out correctly, water may drip down from the unit, wetting the furniture.
- When the outdoor temperature is 0 °C or less, do not use the accessory drain pipe. If the drain pipe is used, the drain water in the pipe may freeze in extremely cold weather.

Since the drain water flows out of the outdoor unit during heating operation, install the drain pipe and connect it to a commercial 16 mm hose.

When installing the drain pipe, plug all the holes other than the drain pipe mounting hole in the bottom of the outdoor unit with putty so there is no water leakage.

(Unit : mm)

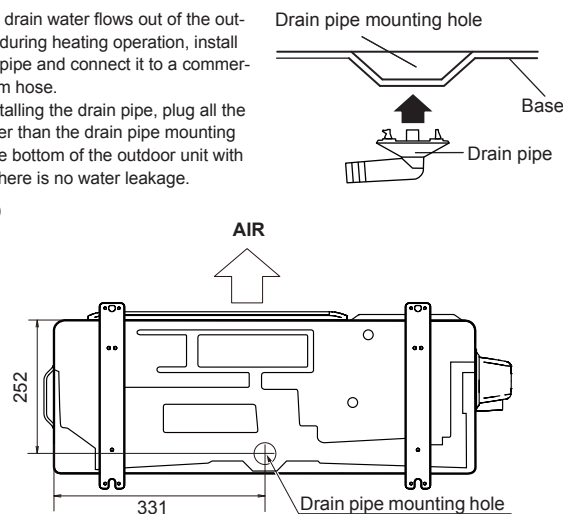

### 10.3. Installation dimensions

#### CAUTION

Keep the space shown in the installation examples. If the installation is not performed accordingly, it could cause a short circuit and result in a lack of operating performance.

#### 10.3.1. Outdoor unit installation

When the upper space is open (Unit : mm)

(1) Obstacles at rear only

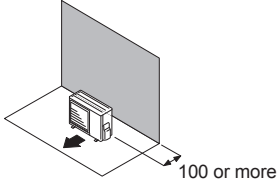

(2) Obstacles at rear and sides

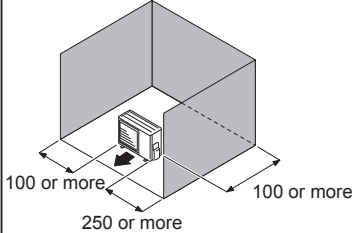

(3) Obstacles at front

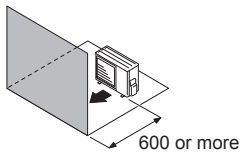

(4) Obstacles at front and rear

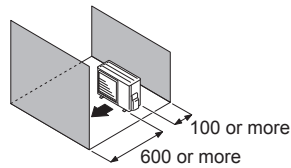

When an obstruction in the upper space (Unit : mm)

(1) Obstacles at rear and above

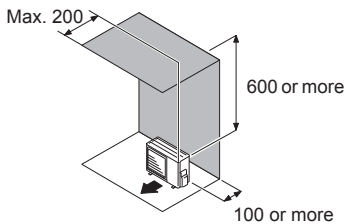

(2) Obstacles at rear, sides, and above

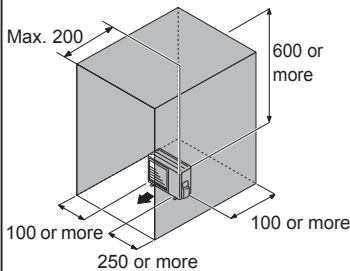

### 10.4. Installation

Install 4 anchor bolts at the locations indicated with arrows in the figure. To reduce vibration, do not install the unit directly on the ground. Install it on a secure base (such as concrete blocks).

The foundation shall support the legs of the unit and have a width of 50 mm or more. Depending on the installation conditions, the outdoor unit may spread its vibration during operation, which may cause noise and vibration. Therefore, attach damping materials (such as damping pads) to the outdoor unit during installation.

Install the foundation, making sure that there is enough space for installing the connection pipes.

Secure the unit to a solid block using foundation bolts. (Use 4 sets of commercially available M10 bolts, nuts, and washers.)

The bolts should protrude 20 mm. (Refer to the figure.)

If overturning prevention is required, purchase the necessary commercially available items.

(Unit : mm)

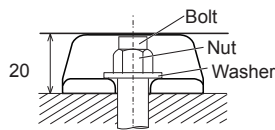
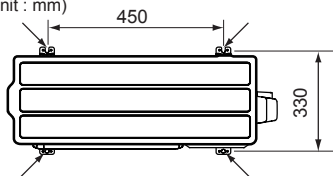

#### CAUTION

- Do not install the outdoor unit in two-stage where the drain water could freeze. Otherwise the drainage from the upper unit may form ice and cause a malfunction of the lower unit.
- When the outdoor temperature is 0 °C or less, do not use the accessory drain pipe. If the drain pipe is used, the drain water in the pipe may freeze in extremely cold climate.

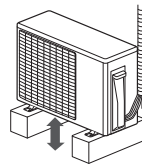

50 mm or more

If the unit is installed in a region that is exposed to high winds, freezing conditions, freezing rain, snow fall or heavy snow accumulation, take appropriate measures to protect it from those elements. To ensure stable operation, the outdoor unit must be installed on a raised stand or rack, at or above the anticipated snow depth for the region.

The installation of snow hoods and drift prevention fencing is recommended when blowing and drifting snow is common to the region.

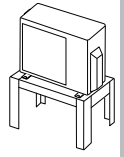

## 11. ELECTRICAL WIRING

[For outdoor unit]

### 11.1. Switch cover removal

#### Switch cover removal

- Remove the tapping screws.
- Slide the switch cover downwards to release.

#### Installing the switch cover

- After inserting the hooks (2 places) on the switch cover into the hole on the outdoor unit, slide the switch cover upwards.
- Replace the tapping screws.

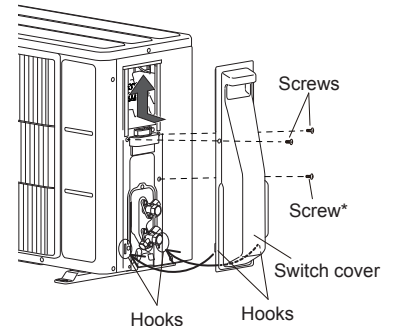

\* Depending on the model, may not be attached.

### 11.2. Notes for electrical wiring

#### WARNING

- Wiring connections must be performed by a qualified person in accordance with the specifications. The voltage rating for this product is 230 V at 50 Hz. It should be operated within the range of 198 to 264 V.
- Before connecting the wires, make sure the power supply is off.
- Never touch electrical components immediately after the power supply has been turned off. Electrical shock may occur. After turning off the power, always wait 10 minutes or more before touching electrical components.
- Use a dedicated power supply circuit. Insufficient power capacity in the electrical circuit or improper wiring may cause electric shock or fire.
- Be sure to install an earth leakage breaker.
- Otherwise, it will cause electric shock or fire.
- A circuit breaker is installed in the permanent wiring. Always use a circuit that can trip all the poles of the wiring and has an isolation distance of at least 3 mm between the contacts of each pole.
- Use designated cables and power cables. Improper use may cause electric shock or fire by poor connection, insufficient insulation, or over current.
- Do not modify power cable, use extension cable or branch wiring. Improper use may cause electric shock or fire by poor connection, insufficient insulation or over current.
- Connect the connector cable securely to the terminal. Check no mechanical force bears on the cables connected to the terminals. Faulty installation can cause a fire.
- Use ring terminals and tighten the terminal screws to the specified torques, otherwise, abnormal overheating may be produced and possibly cause serious damage inside the unit.
- Make sure to secure the insulation portion of the connector cable with the cable clamp. Damaged insulation can cause a short circuit.
- Fix cables so that cables do not make contact with the pipes (especially on high pressure side). Do not make power supply cable and transmission cable come in contact with valves (Gas).
- Never install a power factor improvement condenser. Instead of improving the power factor, the condenser may overheat.

**WARNING**

- Be sure to perform the grounding work.  
Do not connect grounding wires to a gas pipe, water pipe, lightning rod or grounding wire for a telephone.
- Connection to a gas pipe may cause a fire or explosion if gas leaks.
- Connection to a water pipe is not an effective grounding method if PVC pipe is used.
- Connection to the grounding wire of a telephone or to a lightning rod may cause a dangerously abnormal rise in the electrical potential if lightning strikes.
- Improper grounding work can cause electric shocks.
- Securely install the electrical box cover on the unit. An improperly installed service panel can cause serious accidents such as electric shock or fire through exposure to dust or water.
- Do not connect the AC power supply to the transmission line terminal board. Improper wiring can damage the entire system.

**CAUTION**

- The primary power supply capacity is for the air conditioner itself, and does not include the concurrent use of other devices.
- If the electrical power is inadequate, contact your electric power company.
- Install a breaker in a location that is not exposed to high temperatures.  
If the temperature surrounding the breaker is too high, the amperage at which the breaker cuts out may decrease.
- When using an earth leakage breaker that has been designed solely for ground fault protection, be sure to install a fuse-equipped switch or circuit breaker.
- This system uses an inverter, which means that it must be used an earth leakage breaker that can handle harmonics in order to prevent malfunctioning of the earth leakage breaker itself.
- Do not use crossover power supply wiring for the outdoor unit.
- If the temperature surrounding the breaker is too high, the amperage at which the breaker cuts out may decrease.
- When the electrical switchboard is installed outdoors, place it under lock and key so that it is not easily accessible.
- Start wiring work after closing branch switch and over current breaker.
- Connection cable between indoor unit and outdoor unit is 230 V.
- Be sure not to remove thermistor sensor etc. from power wiring and connection wiring. Compressor may fail if operated while removed.
- Always keep to the maximum length of the connection cable. Exceeding the maximum length may lead to erroneous operation.
- Do not start operation until the refrigerant is charged completely. The compressor will fail if it is operated before the refrigerant piping charging is complete.
- The static electricity that is charged to the human body can damage the control PC Board when handling the control PC Board for address setting, etc. Please keep caution to the following points.  
Provide the grounding of Indoor unit, Outdoor unit and Option equipment.  
Cut off the power supply (breaker).  
Touch the metal section (such as the unpainted control box section) of the indoor or outdoor unit for more than 10 seconds. Discharge the static electricity in your body.  
Never touch the component terminal or pattern on the PC Board.

**How to connect wiring to the terminal**

**Caution when wiring cable**

When stripping off the coating of a lead wire, always use a special tool such as a wire stripper. If there is no special tool available, carefully strip the coating with a knife etc.

- (1) Use ring terminals with insulating sleeves as shown in the figure below to connect to the terminal block.
- (2) Securely clamp the ring terminals to the wires using an appropriate tool so that the wires do not come loose.

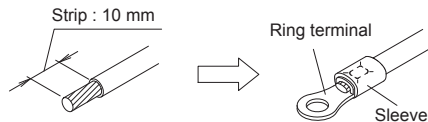

- (3) Use the specified wires, connect them securely, and fasten them so that there is no stress placed on the terminals.
- (4) Use an appropriate screwdriver to tighten the terminal screws. Do not use a screwdriver that is too small, otherwise, the screw heads may be damaged and prevent the screws from being properly tightened.

- (5) Do not tighten the terminal screws too much, otherwise, the screws may break.

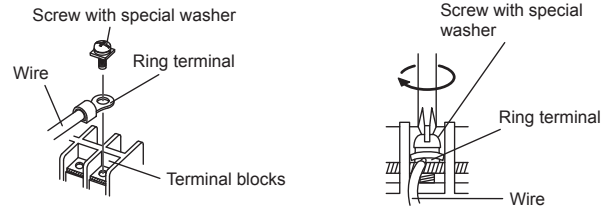

- (6) Refer to the following table for the terminal screw tightening torques.

Tightening torque [N·m (kgf·cm)]	
M3.5 screw	0.8 to 1.0 (8 to 10)
M4 screw	1.2 to 1.8 (12 to 18)
M5 screw	2.0 to 3.0 (20 to 30)

**11.3. Wiring method**

**11.3.1. Connection diagrams**

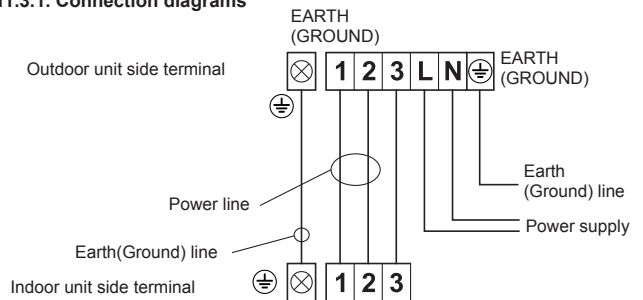

**11.3.2. Cable preparation**

Keep the earth (ground) wire longer than the other wires.

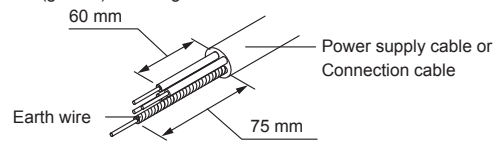

**11.3.3. Wiring procedure**

- (1) Remove the outdoor unit switch cover.(Refer to "11.1. Switch cover removal".)
- (2) Remove the outdoor unit cable clamp.
- (3) Connect the power supply cable and the connection cable to terminal.
- (4) Fasten the power supply cable and connection cable with cable clamp.
- (5) Install the switch cover.(Refer to "11.1. Switch cover removal".)

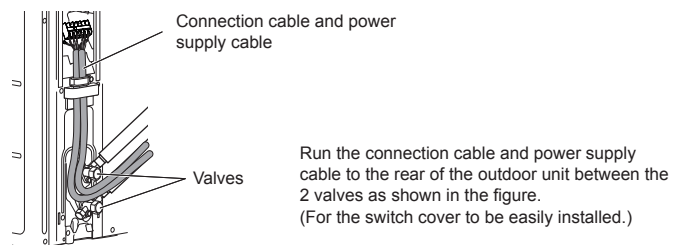
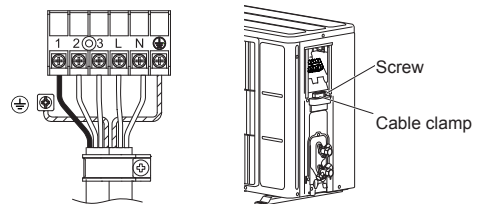

## 12. PIPE INSTALLATION

[For outdoor unit]

### 12.1. Pipe connection

#### CAUTION

- Do not use mineral oil on a flared part. Prevent mineral oil from getting into the system as this would reduce the lifetime of the units.
- While welding the pipes, be sure to blow dry nitrogen gas through them.

#### Flaring

- (1) Cut the connection pipe to the necessary length with a pipe cutter.
- (2) Hold the pipe downward so that cuttings will not enter the pipe and remove the burrs.
- (3) Insert the flare nut onto the pipe and flare the pipe with a flaring tool.

Insert the flare nut (always use the flare nut attached to the indoor and outdoor units respectively) onto the pipe and perform the flare processing with a flare tool. Use the special R32(R410A) flare tool, or the conventional (for R22) flare tool.

When using the conventional flare tool, always use an allowance adjustment gauge and secure the A dimension shown in the following table.

Check if [L] is flared uniformly and is not cracked or scratched.

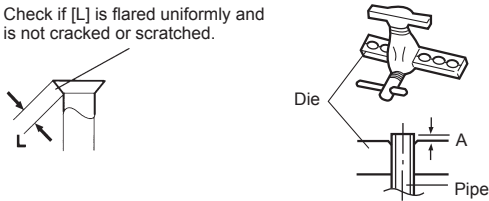

Pipe outside diameter	A (mm)		
	Flaring tool for R32 or R410A, clutch type	Conventional (R22) Flaring tool	
		Clutch type	Wing nut type
ø 6.35 mm (1/4")	0 to 0.5	1.0 to 1.5	1.5 to 2.0
ø 9.52 mm (3/8")			

#### Bending pipes

- (1) When bending the pipe, be careful not to crush it.
- (2) To prevent breaking of the pipe, avoid sharp bends. Bend the pipe with a radius of curvature of 70 mm or more.
- (3) If the copper pipe is bent too often, it will become stiff. Do not bend the pipes more than three times at one place.

#### Flare connection

- (1) Detach the caps and plugs from the pipes.

#### CAUTION

- Be sure to apply the pipe against the port on the indoor unit and the outdoor unit correctly. If the centering is improper, the flare nut cannot be tightened smoothly. If the flare nut is forced to turn, the threads will be damaged.
- Do not remove the flare nut from the indoor unit pipe until immediately before connecting the connection pipe.

- (2) Centering the pipe against port on the outdoor unit, turn the flare nut with your hand.

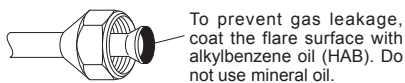

- (3) Tighten the flare nut of the connection pipe at the outdoor unit valve connector.

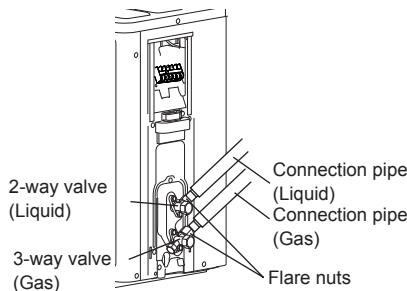

- (4) When the flare nut is tightened properly by your hand, use a torque wrench to finally tighten it.

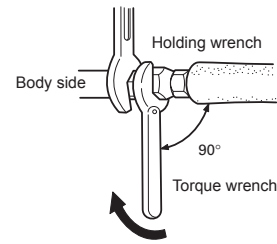

#### CAUTION

Hold the torque wrench at its grip, keeping it in the right angle with the pipe, in order to tighten the flare nut correctly.

Flare nut [mm (in.)]	Tightening torque [N·m (kgf·cm)]
6.35 (1/4) dia.	16 to 18 (160 to 180)
9.52 (3/8) dia.	32 to 42 (320 to 420)

#### CAUTION

- Fasten a flare nut with a torque wrench as instructed in this manual. If fastened too tight, the flare nut may be broken after a long period of time and cause a leakage of refrigerant.
- During installation, make sure that the refrigerant pipe is attached firmly before you run the compressor. Do not operate the compressor under the condition of refrigerant piping not attached properly with 3-way valves open. This may cause abnormal pressure in the refrigeration cycle that leads to breakage and even injury.

### 12.2. Sealing test

#### WARNING

- Before operating the compressor, install the pipes and securely connect them. Otherwise, if the pipes are not installed and if the valves are open when the compressor operates, air could enter the refrigeration cycle. If this happens, the pressure in the refrigeration cycle will become abnormally high and cause damage or injury.
- After the installation, make sure there is no refrigerant leakage. If the refrigerant leaks into the room and becomes exposed to a source of fire such as a fan heater, stove, or burner, it produces a toxic gas.
- Do not subject the pipes to strong shocks during the sealing test. It can rupture the pipes and cause serious injury.

#### CAUTION

- Do not block the walls and the ceiling until the sealing test and the charging of the refrigerant gas have been completed.
- For maintenance purposes, do not bury the piping of the outdoor unit.

- After connecting the pipes, perform a sealing test.
- Make sure that the 3-way valves are closed before performing a sealing test.
- Pressurize nitrogen gas to 4.15 MPa to perform the sealing test.
- Add nitrogen gas to both the liquid pipes and the gas pipes.
- Check all flare connections and welds. Then, check that the pressure has not decreased.
- Compare the pressures after pressurizing and letting it stand for 24 hours, and check that the pressure has not decreased.
- \* When the outdoor air temperature changes 5 °C, the test pressure changes 0.05 MPa. If the pressure has dropped, the pipe joints may be leaking.
- If a leak is found, immediately repair it and perform the sealing test again.
- After completing the sealing test, release the nitrogen gas from both valves.
- Release the nitrogen gas slowly.

## 12.3. Vacuum process

### CAUTION

- Perform a refrigerant leakage test (air tightness test) to check for leaks using nitrogen gas while all valves in the outdoor unit are closed. (Use the test pressure indicated on the nameplate.)
- Be sure to evacuate the refrigerant system using a vacuum pump.
- The refrigerant pressure may sometimes not rise when a closed valve is opened after the system is evacuated using a vacuum pump. This is caused by the closure of the refrigerant system of the outdoor unit by the electronic expansion valve. This will not affect the operation of the unit.
- If the system is not evacuated sufficiently, its performance will drop.
- Use a clean gauge manifold and charging hose that were designed specifically for use with R32(R410A). Using the same vacuum equipment for different refrigerants may damage the vacuum pump or the unit.
- Do not purge the air with refrigerants, but use a vacuum pump to evacuate the system.

#### Refrigerant for purging the air is not charged in the outdoor unit at the factory.

- (1) Remove the cap, and connect the gauge manifold and the vacuum pump to the charging valve by the service hoses.
- (2) Vacuum the indoor unit and the connecting pipes until the pressure gauge indicates  $-0.1$  MPa ( $-76$  cmHg).
- (3) When  $-0.1$  MPa ( $-76$  cmHg) is reached, operate the vacuum pump for at least 60 minutes.
- (4) Disconnect the service hoses and fit the cap to the charging valve to the specified torque.
- (5) Remove the blank caps, and fully open the spindles of the 3-way valves with a hexagon wrench [Torque:  $6\sim 7$  N·m ( $60$  to  $70$  kgf·cm)].
- (6) Tighten the blank caps of the 3-way valves to the specified torque.

		Tightening torque
Blank cap	9.52 mm (3/8 in.)	20 to 25 N·m (200 to 250 kgf·cm)
Charging port cap		12.5 to 16 N·m (125 to 160 kgf·cm)

Use a 4 mm hexagon wrench

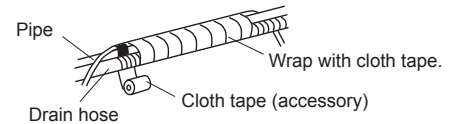
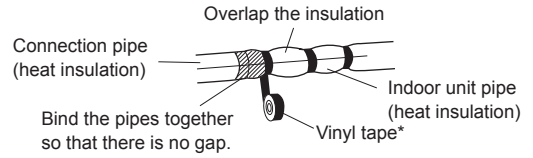
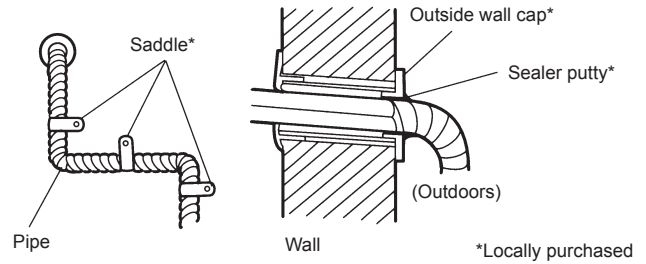
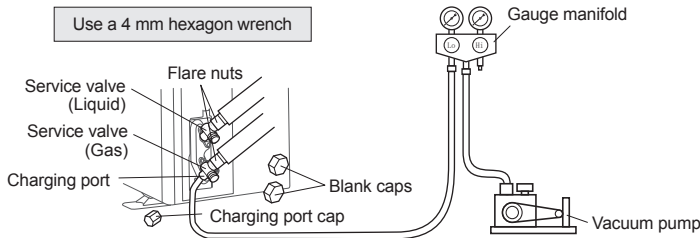

#### GOOD



#### PROHIBITED

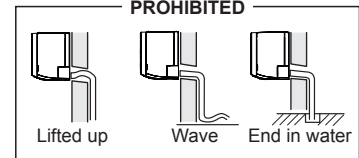

## 12.4. Installing insulation

- Install insulation material after conducting "12.2. Sealing test".
- To prevent condensation and water droplets, install insulation material on the refrigerant pipe.
- Use insulation with heat resistance above  $120$  °C.
- Refer to the table to determine the thickness of the insulation material.

#### Selection of insulation

(Use an insulation material with equal heat transmission rate or below  $0.040$  W/(m·k))

		Insulation material minimum thickness (mm)			
Relative humidity		$\leq 70\%$	$\leq 75\%$	$\leq 80\%$	$\leq 85\%$
Pipe diameter (mm)	6.35	8	10	13	17
	9.52	9	11	14	18

\* When the ambient temperature and relative humidity exceed  $32$  °C (DB) and  $85\%$  respectively, please strengthen the heat insulation of refrigerant pipe.

## 13. FINISHING

- (1) Insulate between pipes.
  - Insulate suction and discharge pipes separately.
  - For rear, right, and bottom piping, overlap the connection pipe heat insulation and indoor unit pipe heat insulation and bind them with vinyl tape so that there is no gap.
- (2) Temporarily fasten the connection cable along the connection pipe with vinyl tape. (Wrap to about  $1/3$  the width of the tape from the bottom of the pipe so that water does not enter.)
- (3) Fasten the connection pipe to the outside wall with a saddle, etc.
- (4) Fill the gap between the outside wall pipe hole and the pipe with sealer so that rain water and wind cannot blow in.
- (5) Fasten the drain hose to the outside wall, etc.
- (6) Check the drainage.

## 14. TEST RUN

#### Check items

- (1) Is operation of each button on the remote controller normal?
- (2) Does each lamp light normally?
- (3) Do airflow direction louvers operate normally?
- (4) Is the drain normal?
- (5) Do not have an abnormal noise and vibration during operation?

Do not operate the air conditioner in test run for a long time.

#### [Operation method]

Depending on your installation, choose from the following:

- By the wireless remote controller (with [TEST RUN] button)
  - To start test run, press [START/STOP] and [TEST RUN] on the remote controller.
  - To end test run, press [START/STOP] on the remote controller.
- By the indoor unit or IR receiver unit
  - To start test run, press [MANUAL AUTO] of the unit for more than 10 seconds (forced cooling).
  - To end test run, press [MANUAL AUTO] for more than 3 seconds or press [START/STOP] on the remote controller.
- By the wired remote controller
  - For the operation method, refer to the installation manual and the operating manual of the wired remote controller.

The Operation indicator lamp and Timer indicator lamp will simultaneously flash during the test run mode.

Heating test run will begin in a few minutes when HEAT is selected by the remote controller [reverse cycle model only].

## 15. CUSTOMER GUIDANCE

Explain the following to the customer in accordance with the operating manual:

- (1) Starting and stopping method, operation switching, temperature adjustment, timer, airflow switching, and other remote control unit operations.
- (2) Air filter removal and cleaning, and how to use the air louvers.
- (3) Give the operating manual to the customer.

## 16. ERROR CODES

If you use a wireless remote controller, the lamp on the photo detector unit will output error codes by way of blinking patterns. If you use a wired remote controller, error codes will appear on the remote control display. See the lamp blinking patterns and error codes in the table. An error display is displayed only during operation.

Error display			Error code	Description
OPERATION lamp (green)	TIMER lamp (orange)	ECONOMY lamp (green)		
●(1)	●(1)	◇	11	Serial communication error
●(1)	●(2)	◇	12	• Wired remote controller communication error • Server room control communication error
●(1)	●(5)	◇	15	Check run unfinished Automatic airflow adjustment error
●(1)	●(8)	◇	18	External communication error
●(2)	●(2)	◇	22	Indoor unit capacity error
●(2)	●(3)	◇	23	Combination error
●(2)	●(6)	◇	26	Indoor unit address setting error
●(2)	●(9)	◇	29	Connection unit number error in wired remote controller system
●(3)	●(1)	◇	31	Power supply interruption error
●(3)	●(2)	◇	32	Indoor unit PCB model information error
●(3)	●(3)	◇	33	Indoor unit motor electricity consumption detection error
●(3)	●(5)	◇	35	Manual auto switch error
●(3)	●(9)	◇	39	Indoor unit power supply error for fan motor
●(3)	●(10)	◇	3A	Indoor unit communication circuit (wired remote controller) error
●(4)	●(1)	◇	41	Room temp. sensor error
●(4)	●(2)	◇	42	Indoor unit heat ex. middle temp. sensor error
●(5)	●(1)	◇	51	Indoor unit fan motor error
●(5)	●(15)	◇	5U	Indoor unit error
●(6)	●(2)	◇	62	Outdoor unit main PCB model information error or communication error
●(6)	●(3)	◇	63	Inverter error
●(6)	●(4)	◇	64	Active filter error, PFC circuit error
●(6)	●(5)	◇	65	Trip terminal L error
●(6)	●(8)	◇	68	Outdoor unit rush current limiting resistor temp. rise error
●(6)	●(10)	◇	6A	Display PCB microcomputers communication error
●(7)	●(1)	◇	71	Discharge temp. sensor error
●(7)	●(2)	◇	72	Compressor temp. sensor error
●(7)	●(3)	◇	73	Outdoor unit Heat Ex. liquid temp. sensor error
●(7)	●(4)	◇	74	Outdoor temp. sensor error
●(7)	●(5)	◇	75	Suction Gas temp. sensor error
●(7)	●(6)	◇	76	• 2-way valve temp. sensor error • 3-way valve temp. sensor error
●(7)	●(7)	◇	77	Heat sink temp. sensor error

Error display			Error code	Description
OPERATION lamp (green)	TIMER lamp (orange)	ECONOMY lamp (green)		
●(8)	●(2)	◇	82	• Sub-cool Heat Ex. gas inlet temp. sensor error • Sub-cool Heat Ex. gas outlet temp. sensor error
●(8)	●(3)	◇	83	Liquid pipe temp. sensor error
●(8)	●(4)	◇	84	Current sensor error
●(8)	●(6)	◇	86	• Discharge pressure sensor error • Suction pressure sensor error • High pressure switch error
●(9)	●(4)	◇	94	Trip detection
●(9)	●(5)	◇	95	Compressor rotor position detection error (permanent stop)
●(9)	●(7)	◇	97	Outdoor unit fan motor 1 error
●(9)	●(8)	◇	98	Outdoor unit fan motor 2 error
●(9)	●(9)	◇	99	4-way valve error
●(10)	●(1)	◇	A1	Discharge temp. error
●(10)	●(3)	◇	A3	Compressor temp. error
●(10)	●(4)	◇	A4	High pressure error
●(10)	●(5)	◇	A5	Low pressure error

Display mode ● : 0.5s ON / 0.5s OFF  
 ◇ : 0.1s ON / 0.1s OFF  
 ( ) : Number of flashing

### [Troubleshooting with the indoor unit display]

