

AIRSTAGE

AIR CONDITIONER

2-unit multi-split type

FUJITSU

REFRIGERANT **R32**
INVERTER

DESIGN & TECHNICAL MANUAL

INDOOR



AUXG07-14KVLA



ARXG07-14KSLAP



ARXG07-14KLLAP



ARXH12-14KMTAP



ASEH07-14KMCG



ASEH07-14KMCG-B



ASEG07-14KETF



ASEG07-14KETF-B



ASEH07-14KGTG



ASEH05-12KNCA



AGEG09-14KVCA

OUTDOOR

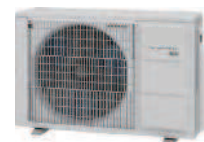

AOEG14KBCA2



AOEG18KBCA2

FUJITSU GENERAL LIMITED

DR_MU021ES_13
2024.07.17

Notices:

- Product specifications and design are subject to change without notice for future improvement.
- For further details, please check with our authorized dealer.

Trademarks

FGLair™ is trademark of FUJITSU GENERAL LIMITED in the United States, other countries or both.

“AIRSTAGE Mobile” is a trademark of FUJITSU GENERAL LIMITED.

Android and Google Play are trademarks of Google LLC.

App Store is a service mark of Apple Inc., registered in the U.S. and other countries.

IOS is a trademark or registered trademark of Cisco in the U.S. and other countries and is used under license.

CONTENTS

Part 1. INDOOR UNIT.....1

1. Model lineup	2
1-1. Connectable indoor units to each outdoor unit.....	3
1-2. Indoor unit connection patterns.....	4
2. Specifications	5
2-1. Compact cassette type	5
2-2. Mini duct type.....	6
2-3. Slim duct type	7
2-4. Medium static pressure duct type	8
2-5. Wall mounted type	9
2-6. Floor type.....	13
3. Wireless LAN control (for KMCG, KMCG-B, KETF, KETF-B, KGTG, and KNCA).....	14
3-1. System requirement.....	14
4. Dimensions.....	15
4-1. Compact cassette type	15
4-2. Mini duct type.....	17
4-3. Slim duct type	19
4-4. Medium static pressure duct type	21
4-5. Wall mounted type	24
4-6. Floor type.....	33
5. Wiring diagrams	35
5-1. Compact cassette type	35
5-2. Mini duct type and Slim duct type	36
5-3. Medium static pressure duct type	37
5-4. Wall mounted type	38
5-5. Floor type.....	42
6. Air velocity and temperature distributions	43
6-1. Compact cassette type	43
6-2. Mini duct type.....	49
6-3. Slim duct type	57
6-4. Wall mounted type	65
6-5. Floor type.....	71
7. Fan performance	72
7-1. Mini duct type.....	72
7-2. Slim duct type	80
7-3. Medium static pressure duct type	88
8. Airflow	92
8-1. Compact cassette type	92
8-2. Mini duct type.....	93
8-3. Slim duct type	94

CONTENTS (continued)

8-4. Medium static pressure duct type	95
8-5. Wall mounted type	96
8-6. Floor type	99
9. Noise level curve	100
9-1. Compact cassette type	100
9-2. Mini duct type	102
9-3. Slim duct type	104
9-4. Medium static pressure duct type	106
9-5. Wall mounted type	107
9-6. Floor type	115
9-7. Sound level check point	117
10. Electrical characteristics	120
11. Safety devices	121
12. External input and output	122
12-1. Compact cassette type and Medium static pressure duct type	122
12-2. Mini duct type and Slim duct type	133
12-3. Wall mounted type (KMCG, KMCG-B, KETF, KETF-B, and KGTG)	139
12-4. Floor type	152
13. Group connection	161
14. Remote controller	162
14-1. Wireless remote controller (AR-REW4E and AR-REJ1E)	162
14-2. Wireless remote controller (AR-REW3E)	165
14-3. Wireless remote controller (AR-REM7E)	167
14-4. Wireless remote controller (AR-RMB1E and AR-RMB1E-B)	169
14-5. Wireless remote controller (UTY-LNTY: Optional part) and IR receiver kit with Wireless remote controller (UTY-LBTYM: Optional part)	171
14-6. Wireless remote controller (AR-RPF4E)	174
14-7. Wired remote controller (UTY-RNNYM: Optional part)	176
14-8. Wired Remote Controller (UTY-RVRY : Optional part)	179
14-9. Wired remote controller (UTY-RLRY: Optional part)	189
14-10. Wired remote controller (UTY-RVNYM: Optional part)	192
14-11. Wired remote controller (UTY-RNRYZ*: Optional part)	199
14-12. Wired remote controller (UTY-RCRYZ1: Optional part)	202
14-13. Simple remote controller (UTY-RSNYM: Optional part)	206
14-14. Simple remote controller (UTY-RSRY and UTY-RHRY: Optional parts)	209
15. Function settings	212
15-1. Compact cassette, Mini duct, Slim duct types indoor unit (setting by DIP switch)	212
15-2. Medium static pressure duct type	214
15-3. Indoor unit (setting by wireless remote controller)	215
15-4. Indoor unit (setting by wired remote controller)	235
15-5. Indoor unit (setting by simple remote controller)	248
15-6. Function details	255
15-7. Wired remote controller (UTY-RNNYM)	263

CONTENTS (continued)

15-8.Wired remote controller (UTY-RVNYM)	265
15-9.Wired remote controller (UTY-RLRY)	266
15-10.Wired remote controller (UTY-RNRYZ*)	266
15-11.Simple remote controller (UTY-RSNYM).....	267
16. Accessories	268
16-1.Compact cassette type	268
16-2.Mini duct type	269
16-3.Slim duct type	270
16-4.Medium static pressure duct type	271
16-5.Wall mounted type	272
16-6.Floor type	274
17. Optional parts	275
17-1.Controllers	275
17-2.Cassette grille	279
17-3.Others	280
18. Indoor unit installation precautions	286
18-1.Places where prohibited for use	286
18-2.Points to remember when installing	286

CONTENTS (continued)

Part 2. OUTDOOR UNIT (2 UNITS TYPE)	289
1. Specifications	290
2. Dimensions	292
2-1. Model: AOEG14KBCA2	292
2-2. Model: AOEG18KBCA2	293
3. Installation space	294
3-1. Models: AOEG14KBCA2 and AOEG18KBCA2	294
4. Refrigerant circuit	297
4-1. Model: AOEG14KBCA2	297
4-2. Model: AOEG18KBCA2	298
5. Wiring diagram	299
5-1. Model: AOEG14KBCA2	299
5-2. Model: AOEG18KBCA2	300
6. Capacity table	301
6-1. Combinations	301
6-2. Cooling capacity.....	305
6-3. Heating capacity	327
7. Capacity compensation rate for pipe length and height difference	349
7-1. Model: AOEG14KBCA2	349
7-2. Model: AOEG18KBCA2	351
8. Additional charge calculation	353
8-1. Model: AOEG14KBCA2	353
8-2. Model: AOEG18KBCA2	353
9. Airflow	354
9-1. Model: AOEG14KBCA2	354
9-2. Model: AOEG18KBCA2	354
10. Operation noise (sound pressure)	355
10-1.Noise level curve.....	355
10-2.Sound level check point	356
11. Electrical characteristics	357
12. Safety devices	358
13. Accessories	359
13-1.Models: AOEG14KBCA2 and AOEG18KBCA2	359
14. Outdoor unit installation precautions	360
14-1.Places where prohibited for use.....	360
14-2.Points to remember when installing	360

Part 1. INDOOR UNIT

COMPACT CASSETTE TYPE:

AUXG07-14KVLA

MINI DUCT TYPE:

ARXG07-14KSLAP

SLIM DUCT TYPE:

ARXG07-14KLLAP

MEDIUM STATIC PRESSURE DUCT TYPE:

ARXH12-14KMTAP

WALL MOUNTED TYPE:

ASEH07-14KMCG

ASEH07-14KMCG-B

ASEH07-14KGTG

ASEG07-14KETF-B

ASEH05-12KNCA

FLOOR TYPE:

AGEG09-14KVCA

1. Model lineup

Indoor unit			
 <p>AUXG07KVLA AUXG09KVLA AUXG12KVLA AUXG14KVLA</p>	 <p>ARXG07KSLAP ARXG09KSLAP ARXG12KSLAP ARXG14KSLAP</p>	 <p>ARXG07KLLAP ARXG09KLLAP ARXG12KLLAP ARXG14KLLAP</p>	 <p>ARXH12KMTAP ARXH14KMTAP</p>
 <p>ASEH07KMCG ASEH09KMCG ASEH12KMCG ASEH14KMCG</p>	 <p>ASEH07KMCG-B ASEH09KMCG-B ASEH12KMCG-B ASEH14KMCG-B</p>	 <p>ASEG07KETF ASEG09KETF ASEG12KETF ASEG14KETF</p>	 <p>ASEG07KETF-B ASEG09KETF-B ASEG12KETF-B ASEG14KETF-B</p>
 <p>ASEH07KGTG ASEH09KGTG ASEH12KGTG ASEH14KGTG</p>	 <p>ASEH05KNCA ASEH07KNCA ASEH09KNCA ASEH12KNCA</p>	 <p>AGEG09KVCA AGEG12KVCA AGEG14KVCA</p>	
Outdoor unit			
 <p>AOEG14KBCA2</p>		 <p>AOEG18KBCA2</p>	

1-1. Connectable indoor units to each outdoor unit

●: Connectable / -: Not connectable

Outdoor unit	Compact cassette				Mini duct			
	AUXG07-14KVLA				ARXG07-14KSLAP			
Btu class	07	09	12	14	07	09	12	14
kW class	2.0	2.5	3.5	4.0	2.0	2.5	3.5	4.0
AOEG14KBCA2	●	●	●	—	●	●	●	—
AOEG18KBCA2	●	●	●	●	●	●	●	●

Outdoor unit	Slim duct				Medium static pressure duct			
	ARXG07-14KLLAP				ARXH12-14KMTAP			
Btu class	07	09	12	14	12	14		
kW class	2.0	2.5	3.5	4.0	3.5	4.0		
AOEG14KBCA2	●	●	●	—	●	—		
AOEG18KBCA2	●	●	●	●	●	●		

Outdoor unit	Wall mounted							
	KM				KE			
	ASEH07-14KMCG ASEH07-14KMCG-B				ASEG07-14KETF ASEG07-14KETF-B			
Btu class	07	09	12	14	07	09	12	14
kW class	2.0	2.5	3.5	4.0	2.0	2.5	3.5	4.0
AOEG14KBCA2	●	●	●	—	●	●	●	—
AOEG18KBCA2	●	●	●	●	●	●	●	●

Outdoor unit	Wall mounted							
	KG				KN			
	ASEH07-14KGTG				ASEH05-12KNCA			
Btu class	07	09	12	14	05	07	09	12
kW class	2.0	2.5	3.5	4.0	1.5	2.0	2.5	3.5
AOEG14KBCA2	●	●	●	—	●	●	●	●
AOEG18KBCA2	●	●	●	●	●	●	●	●

Outdoor unit	Floor							
	AGEG09-14KVCA							
Btu class	09			12			14	
kW class	2.5			3.5			4.0	
AOEG14KBCA2	●			●			—	
AOEG18KBCA2	●			●			●	

1-2. Indoor unit connection patterns

■ 2 units

AOEG14KBCA2			
Combination no.	Unit 1	Unit 2	Total
1	5	5	10
2	5	7	12
3	5	9	14
4	5	12	17
5	7	7	14
6	7	9	16
7	7	12	19
8	9	9	18
9	9	12	21

AOEG18KBCA2			
Combination no.	Unit 1	Unit 2	Total
1	5	5	10
2	5	7	12
3	5	9	14
4	5	12	17
5	5	14	19
6	7	7	14
7	7	9	16
8	7	12	19
9	7	14	21
10	9	9	18
11	9	12	21
12	9	14	23
13	12	12	24
14	12	14	26

Numbers in column Unit 1, 2, and Total indicate the indoor unit capacities as follows:
 5: 5,000 Btu/h, 7: 7,000 Btu/h, 9: 9,000 Btu/h, 12: 12,000 Btu/h, 14: 14,000 Btu/h

2. Specifications

2-1. Compact cassette type

Model name				AUXG07KVLA	AUXG09KVLA	AUXG12KVLA	AUXG14KVLA	
Power supply				1Ø 230 V~ 50 Hz				
Available voltage range				198—264 V				
Capacity		kW class		2.0	2.5	3.5	4.0	
Input power		W		18		23	28	
Running current		A		0.15		0.19	0.22	
Fan	Airflow rate	Cooling	HIGH	m ³ /h	540		610	680
			MED		490		530	580
			LOW		440		470	490
			QUIET		390		410	410
		Heating	HIGH		540		610	790
			MED		490		530	680
			LOW		440		470	580
			QUIET		390		410	450
	Type × Qty		Turbo fan × 1					
	Motor output		W		54			
Sound pressure level*	Cooling	dB (A)	HIGH	33		37	38	
			MED	31		34	35	
			LOW	29		31	32	
			QUIET	27		28	29	
	Heating	dB (A)	HIGH	34		37	43	
			MED	32		34	38	
			LOW	29		31	34	
			QUIET	27		29	30	
Sound power level	Cooling	dB (A)	46		49	50		
	Heating		47		49	55		
Heat exchanger type	Dimensions (H × W × D)		mm	Main 1: 210 × 1,310 × 13.3 Main 2: 210 × 1,250 × 13.3				
	Fin pitch		mm	Main 1: 1.2 Main 2: 1.2				
	Rows × Stages			Main 1: 1 × 10 Main 2: 1 × 10				
	Pipe type			Copper tube				
	Fin type			Aluminum				
Dimensions (H × W × D)	Net		mm	245 × 570 × 570				
	Gross			265 × 730 × 625				
Weight	Net		kg	15				
	Gross			19				
Connection pipe	Size	Liquid	mm (in)	Ø6.35 (Ø1/4)				
		Gas		Ø9.52 (Ø3/8)				
	Method			Flare				
Operation range	Cooling	°C	18 to 32					
		%RH	80 or less					
	Heating	°C	16 to 30					
Drain hose	Material		Polyvinyl chloride					
	Tip diameter		mm	VP25 (Ø25 [I.D.], Ø32 [O.D.])				
Cassette grille (Grid type: Option)	Model name		UTG-UFYF-W					
	Material		Polystyrene					
	Color		White Approximate color of Munsell 9PB 9.1/0.2					
	Dimensions (H × W × D)	Net	mm	49 × 620 × 620				
		Gross		120 × 765 × 755				
	Weight	Net	kg	2.3				
Gross		4.5						

NOTES:

- The protective function might work when using it outside the operation range.
- *: Sound pressure level:
 - These are the measured values in the manufacturer's anechoic chamber.
 - Because of the surrounding sound environment, the sound levels measured in actual installation conditions might be higher than the specified values here.

2-2. Mini duct type

Model name				ARXG07KSLAP	ARXG09KSLAP	ARXG12KSLAP	ARXG14KSLAP	
Power supply				1Ø 230 V~ 50 Hz				
Available voltage range				198—264 V				
Capacity			kW class	2.0	2.5	3.5	4.0	
Input power	Fan	HIGH	W	33	40	47	72	
		MED		23	23	26	44	
		LOW		20	20	22	30	
		QUIET		18	18	18	18	
Running current			A	0.29	0.33	0.38	0.58	
Fan	Airflow rate	Cooling	HIGH	m ³ /h	550	600	650	800
			MED		440	450	490	640
			LOW		390	400	430	530
			QUIET		360	360	360	360
		Heating	HIGH		550	600	650	800
			MED		440	450	490	640
			LOW		390	400	430	530
			QUIET		360	360	360	360
	Type × Qty		Sirocco fan × 2					
	Motor output		W	75				
Recommended static pressure			Pa	0 to 30			0 to 50	
Sound pressure level*	Cooling	HIGH	dB (A)	29		31	35	
		MED		26		27	30	
		LOW		24		25	27	
		QUIET		23		23	23	
	Heating	HIGH		29		31	35	
		MED		26		27	30	
		LOW		24		25	27	
		QUIET		23		23	23	
Sound power level			dB (A)	52	54	55	60	
Heat exchanger type			mm	336 × 490 × 26.6				
Dimensions (H × W × D)			mm	1.3				
Fin pitch			mm	2 × 16				
Rows × Stages				Copper tube				
Pipe type				Aluminum				
Fin type				Steel sheet				
Enclosure				—				
Material				—				
Color				—				
Dimensions (H × W × D)	Net		mm	198 × 700 × 450				
	Gross			250 × 930 × 580				
Weight	Net		kg	15.5				
	Gross			19.0				
Connection pipe	Size	Liquid	mm (in)	Ø6.35 (Ø1/4)				
		Gas		Ø9.52 (Ø3/8)				
	Method			Flare				
Operation range	Cooling		°C	18 to 32				
			%RH	80 or less				
	Heating		°C	16 to 30				
Drain hose	Material		Hard Polyvinyl chloride					
	Tip diameter		mm	Ø25 (I.D.), Ø32 (O.D.)				

NOTES:

- Values mentioned in the table are based on the following conditions:
 - Static pressure: 07-12 models: 10 Pa, 14 model: 15 Pa
- The protective function might work when using it outside the operation range.
- *: Sound pressure level:
 - These are the measured values in the manufacturer's anechoic chamber.
 - Because of the surrounding sound environment, the sound levels measured in actual installation conditions might be higher than the specified values here.

2-3. Slim duct type

Model name				ARXG07KLLAP	ARXG09KLLAP	ARXG12KLLAP	ARXG14KLLAP	
Power supply				1Ø 230 V~ 50 Hz				
Available voltage range				198—264 V				
Capacity		kW class		2.0	2.5	3.5	4.0	
Input power		W		33	49	58	76	
Running current		A		0.33	0.30	0.35	0.51	
Fan	Airflow rate	Cooling	HIGH	m ³ /h	550	600	650	800
			MED		490	550	600	700
			LOW		470	500	550	600
			QUIET		440	450	480	480
		Heating	HIGH		550	600	650	800
			MED		490	550	600	700
			LOW		470	500	550	600
			QUIET		440	450	480	480
	Type × Qty		Sirocco fan × 2					
	Motor output		W		80	81		
Recommended static pressure				Pa				
				0 to 90				
Sound pressure level*	Cooling	HIGH	dB (A)	28		29	32	
		MED		26	27	28	30	
		LOW		25	26	27	28	
		QUIET		24	25	26	28	
	Heating	HIGH		28		29	32	
		MED		26		28	30	
		LOW		25		27	28	
		QUIET		24		27	28	
Sound power level				dB (A)		57	58	
						57	58	
Heat exchanger type				Dimensions (H × W × D)		294 × 500 × 26.6		
				mm		294 × 500 × 39.9		
				Fin pitch		mm		
						1.3		
				Rows × Stages		2 × 14		
						3 × 14		
				Pipe type		Copper tube		
						Aluminum		
				Fin type		Steel sheet		
Enclosure				Material		—		
				Color		—		
Dimensions (H × W × D)				Net		mm		
				Gross		198 × 700 × 620		
						276 × 968 × 772		
Weight				Net		kg		
				Gross		16		
						21		
Connection pipe				Size		mm (in)		
				Liquid		Ø6.35 (Ø1/4)		
				Gas		Ø9.52 (Ø3/8)		
				Method		Flare		
Operation range				Cooling		°C		
						18 to 32		
				Heating		%RH		
						80 or less		
						°C		
						16 to 30		
Drain hose				Material		Polyvinyl chloride		
				Tip diameter		mm		
						Ø25 (I.D.), Ø32 (O.D.)		

NOTES:

- Values mentioned in the table are based on the following conditions:
 - Static pressure: 25 Pa
- The protective function might work when using it outside the operation range.
- *: Sound pressure level:
 - These are the measured values in the manufacturer's anechoic chamber.
 - Because of the surrounding sound environment, the sound levels measured in actual installation conditions might be higher than the specified values here.

2-4. Medium static pressure duct type

Model name				ARXH12KMTAP	ARXH14KMTAP	
Power supply				230 V~ 50 Hz		
Available voltage range				198—264 V		
Capacity		kW class		3.5	4.0	
Input power		W		46	70	
Running current		A		0.34	0.49	
Fan	Airflow rate	Cooling	HIGH	m ³ /h	650	800
			MED		520	640
			LOW		460	560
			QUIET		390	480
		Heating	HIGH		650	800
			MED		520	640
			LOW		460	560
			QUIET		390	480
	Type × Qty		Sirocco fan × 1			
	Motor output		W		150	
Static pressure range				Pa		
				30 to 150		
Sound pressure level*1	Cooling	HIGH	dB (A)	29	32	
		MED		27	29	
		LOW		25	27	
		QUIET		23	25	
	Heating	HIGH		29	32	
		MED		27	29	
		LOW		25	27	
		QUIET		23	25	
Sound power level	Cooling	HIGH	dB (A)	58	59	
	Heating	58		59		
Heat exchanger	Dimensions (H × W × D)		mm	336 × 490 × 39.9		
	Fin pitch			1.4		
	Rows × Stages			3 × 16		
	Pipe type			Copper tube		
	Fin type			Aluminum		
Enclosure	Material		Steel sheet			
	Color		—			
Dimensions (H × W × D)	Net		mm	240 × 700 × 700		
	Gross			334 × 926 × 863		
Weight	Net		kg	24		
	Gross			29		
Connection pipe	Size	Liquid	mm (in)	Ø6.35 (Ø1/4)		
		Gas		Ø9.52 (Ø3/8)		
	Method			Flare		
Drain port	Material		Polyvinyl chloride			
	Tip diameter		mm			
Drain hose	Material		Polyvinyl chloride			
	Tip diameter		mm			
Operation range	Cooling	°C		18 to 32		
		%RH		80 or less		
	Heating	°C		16 to 30		
Remote controller (Option)				Wireless, Wired, Mobile app*2 [FGLair™, AIRSTAGE Mobile]		

NOTES:

- Values mentioned in the table are based on the following conditions:
 - Static pressure: 40 Pa
- The protective function might work when using it outside the operation range.
- *1: Sound pressure level:
 - These are the measured values in the manufacturer's anechoic chamber.
 - Because of the surrounding sound environment, the sound levels measured in actual installation conditions might be higher than the specified values here.
- *2: Available on Google Play™ store or on App Store®. Optional WLAN Adapter is also required. For details, refer to the setting manual.

2-5. Wall mounted type

Model name				ASEH07KMCG ASEH07KMCG-B	ASEH09KMCG ASEH09KMCG-B	ASEH12KMCG ASEH12KMCG-B	ASEH14KMCG ASEH14KMCG-B	
Power supply				1Ø 230 V~ 50 Hz				
Available voltage range				198—264 V				
Capacity			kW class	2.0	2.5	3.5	4.0	
Input power				W	23	27	33	
Running current				A	0.20	0.24	0.30	
Fan	Airflow rate	Cooling	HIGH	m ³ /h	650	700	770	
			MED		540	560	600	
			LOW		430			450
			QUIET		320			310
		Heating	HIGH		720	750	780	820
			MED		580	610	640	660
			LOW		460	470	520	520
			QUIET		330			340
	Type × Qty			Crossflow fan × 1				
	Motor output			W	27			
Sound pressure level*1	Cooling	HIGH	dB (A)	38	40	43		
		MED		33	34	35	36	
		LOW		29		30		
		QUIET		21				
	Heating	HIGH		41	42	44		
		MED		35	36	38	39	
		LOW		31		33		
		QUIET		22			24	
Sound power level	Cooling	dB (A)	54	55	57			
	Heating		56	57	58	59		
Heat exchanger type	Dimensions (H × W × D)		mm	Main 1: 210 × 670 × 26.6 Main 2: 112 × 670 × 20.0			Main 1: 210 × 670 × 26.6 Main 2: 112 × 670 × 20.0 Sub: 84 × 670 × 13.3	
	Fin pitch			Main 1: 1.2 Main 2: 1.1	Main 1: 1.2 Main 2: 1.1 Sub: 1.4			
	Rows × Stages		Main 1: 2 × 10 Main 2: 2 × 7	Main 1: 2 × 10 Main 2: 2 × 7 Sub: 1 × 4				
	Pipe type		Copper tube					
	Fin type		Aluminum					
	Material		Polystyrene					
Enclosure	Color		KMCG: White + Pearl white (painted) Approximate color of Munsell N 9.25/ KMCG-B: Dark gray (painted) Approximate color of Munsell N3/					
	Net		mm	270 × 834 × 222				
Gross		KMCG: 277 × 914 × 332 KMCG-B: 284 × 925 × 341						
Weight	Net		kg	10.0				
	Gross			KMCG: 12.5 KMCG-B: 13.5		KMCG: 13.0 KMCG-B: 13.5		
Connection pipe	Size	Liquid	mm (in)	Ø6.35 (Ø1/4)				
		Gas		Ø9.52 (Ø3/8)				
	Method			Flare				
Drain hose	Material		Polypropylene + High-density polyethylene					
	Tip diameter		mm	Ø13.8 (I.D.), Ø15.0 to Ø16.8 (O.D.)				
Operation range	Cooling		°C	18 to 32				
	Heating		%RH	80 or less				
Remote controller type		°C	16 to 30					
Remote controller type				Wireless (Option: Wired, Mobile app*2 [AIRSTAGE Mobile])				
NOTES:								
<ul style="list-style-type: none"> The protective function might work when using it outside the operation range. *1: Sound pressure level: <ul style="list-style-type: none"> These are the measured values in the manufacturer's anechoic chamber. Because of the surrounding sound environment, the sound levels measured in actual installation conditions might be higher than the specified values here. *2: Available on Google Play™ store or on App Store®. 								

Model name				ASEG07KETF ASEG07KETF-B	ASEG09KETF ASEG09KETF-B	ASEG12KETF ASEG12KETF-B	ASEG14KETF ASEG14KETF-B	
Power supply				1Ø 230 V~ 50 Hz				
Available voltage range				198—264 V				
Capacity		kW class		2.0	2.5	3.5	4.0	
Input power		W		23	27		33	
Running current		A		0.20	0.24		0.30	
Fan	Airflow rate	Cooling	HIGH	m ³ /h	650	700		770
			MED		540	560		600
			LOW		430			450
			QUIET		270			280
		Heating	HIGH		720	750	770	800
			MED		580	610	640	660
			LOW		460	470	520	
			QUIET		330			340
	Type × Qty		Crossflow fan × 1					
	Motor output		W		30			49
Sound pressure level*1	Cooling	HIGH	dB (A)	38	40		43	
		MED		33	34	35	36	
		LOW		29			30	
		QUIET		21				
	Heating	HIGH		41	42	42	44	
		MED		35	36	38	39	
		LOW		31			33	
		QUIET		22			24	
Sound power level		dB (A)		54	55		57	
				56	57	58	59	
Heat exchanger type	Dimensions (H × W × D)		mm	Main 1: 210 × 670 × 26.6 Main 2: 112 × 670 × 20.0			Main 1: 210 × 670 × 26.6 Main 2: 112 × 670 × 20.0 Sub: 84 × 670 × 13.3	
	Fin pitch		mm	Main 1: 1.2 Main 2: 1.1			Main 1: 1.2 Main 2: 1.1 Sub: 1.4	
	Rows × Stages			Main 1: 2 × 10 Main 2: 2 × 7			Main 1: 2 × 10 Main 2: 2 × 7 Sub: 1 × 4	
	Pipe type			Copper tube				
	Fin type			Aluminum				
Enclosure	Material		Polystyrene					
	Color		KETF: White + Pearl white (painted) Approximate color of Munsell N 9.25/ KETF-B: Dark Gray + Silver (painted) Approximate color of Munsell 0.5P 3.5/0.2					
Dimensions (H × W × D)	Net		mm	295 × 950 × 230				
	Gross			284 × 1,027 × 357				
Weight	Net		kg	11.0			11.5	
	Gross			14.5			15.0	
Connection pipe	Size	Liquid	mm (in)	Ø6.35 (Ø1/4)				
		Gas		Ø9.52 (Ø3/8)				
	Method			Flare				
Drain hose	Material		Polypropylene + High-density polyethylene					
	Tip diameter		mm	Ø13.8 (I.D.), Ø15.0 to Ø16.8 (O.D.)				
Operation range	Cooling		°C	18 to 32				
	Heating		%RH	80 or less				
		°C		16 to 30				
Remote controller type				Wireless (Option: Wired, Mobile app*2 [AIRSTAGE Mobile])				
NOTES:								
<ul style="list-style-type: none"> The protective function might work when using it outside the operation range. *1: Sound pressure level: <ul style="list-style-type: none"> These are the measured values in the manufacturer's anechoic chamber. Because of the surrounding sound environment, the sound levels measured in actual installation conditions might be higher than the specified values here. *2: Available on Google Play™ store or on App Store®. 								

Model name				ASEH07KGTG	ASEH09KGTG	ASEH12KGTG	ASEH14KGTG	
Power supply				1Ø 230 V~ 50 Hz				
Available voltage range				198—264 V				
Capacity			kW class	2.0	2.5	3.5	4.0	
Input power			W	23	27		33	
Running current			A	0.20	0.24		0.29	
Fan	Airflow rate	Cooling	HIGH	650	700		770	
			MED	540	560		600	
			LOW	430				450
			QUIET	270				280
		Heating	HIGH	720	750	770		800
			MED	580	610	640		660
			LOW	460	470	520		
			QUIET	330				340
	Type × Qty			Crossflow fan × 1				
	Motor output			W	30	49		
Sound pressure level*1	Cooling	HIGH	38	40		43		
		MED	33	34	35	36		
		LOW	29			30		
		QUIET	21					
	Heating	HIGH	41	42		44		
		MED	35	36	38	39		
		LOW	31			33		
		QUIET	22				24	
Sound power level	Cooling	dB (A)	54	55	56	57		
	Heating		56	57	58	59		
Heat exchanger type	Dimensions (H × W × D)		mm	Main 1: 210 × 670 × 26.6 Main 2: 112 × 670 × 20.0		Main 1: 210 × 670 × 26.6 Main 2: 112 × 670 × 20.0 Sub: 84 × 670 × 13.3		
	Fin pitch		mm	Main 1: 1.2 Main 2: 1.1		Main 1: 1.2 Main 2: 1.1 Sub: 1.4		
	Rows × Stages			Main 1: 2 × 10 Main 2: 2 × 7		Main 1: 2 × 10 Main 2: 2 × 7 Sub: 1 × 4		
	Pipe type			Copper tube				
	Fin type			Aluminum				
Enclosure	Material		Polystyrene					
	Color		White + Pearl white (painted) Approximate color of Munsell N 9.25/					
Dimensions (H × W × D)	Net	mm	270 × 834 × 215					
	Gross		277 × 914 × 332					
Weight	Net	kg	10.0					
	Gross		12.5	13.0				
Connection pipe	Size	Liquid	mm (in)	Ø6.35 (Ø1/4)				
		Gas		Ø9.52 (Ø3/8)				
	Method			Flare				
Drain hose	Material		Polypropylene + High-density polyethylene					
	Tip diameter		mm	Ø13.8 (I.D.), Ø15.0 to Ø16.8 (O.D.)				
Operation range	Cooling	°C	18 to 32					
	Heating	%RH	80 or less					
Remote controller type	Cooling	°C	16 to 30					
	Heating		Wireless (Option: Wired, Mobile app*2 [AIRSTAGE Mobile])					

NOTES:

- The protective function might work when using it outside the operation range.
- *1: Sound pressure level:
 - These are the measured values in the manufacturer's anechoic chamber.
 - Because of the surrounding sound environment, the sound levels measured in actual installation conditions might be higher than the specified values here.
- *2: Available on Google Play™ store or on App Store®.

Model name				ASEH05KNCA	ASEH07KNCA	ASEH09KNCA	ASEH12KNCA		
Power supply				1Ø 230 V~ 50 Hz					
Available voltage range				198—264 V					
Capacity		kW class		1.5	2.0	2.5	3.5		
Input power		W		12	13	21	22		
Running current		A		0.11	0.12	0.19	0.20		
Fan	Airflow rate	Cooling	HIGH	m ³ /h	500	530	640	660	
			MED		450	460	500	520	
			LOW		390			440	
			QUIET		250				
		Heating	HIGH		500	530	640	660	
			MED		450	460	500	520	
			LOW		420			440	
			QUIET		280				
	Type × Qty	Crossflow fan × 1							
	Motor output	W		27					
Sound pressure level*1	Cooling	HIGH	dB (A)	34	36	41	42		
				MED	33		35	36	
				LOW	29			32	
				QUIET	21				
	Heating	HIGH		34	36	41	42		
		MED		32	33	34	35		
		LOW		30			31		
		QUIET		22					
	Sound power level	Cooling		dB (A)		50	51	56	57
		Heating				50	51	56	57
Heat exchanger type	Dimensions (H × W × D)		mm	Main 1: 210 × 600 × 26.6 Main 2: 112 × 600 × 20.0					
	Fin pitch		mm	Main 1: 1.2 Main 2: 1.1					
	Rows × Stages			Main 1: 2 × 10 Main 2: 2 × 7					
	Pipe type			Copper tube					
	Fin type			Aluminum					
Enclosure	Material			Polystyrene					
	Color			White + Pearl white (painted) Approximate color of Munsell N 9.25/					
Dimensions (H × W × D)	Net	mm		270 × 784 × 222					
	Gross			279 × 864 × 334					
Weight	Net	kg		9.0					
	Gross			12.0					
Connection pipe	Size	Liquid	mm (in)	Ø6.35 (Ø1/4)					
		Gas		Ø9.52 (Ø3/8)					
	Method	Flare							
Drain hose	Material			Polypropylene + High-density polyethylene					
	Tip diameter		mm	Ø13.8 (I.D.), Ø15.0 to Ø16.8 (O.D.)					
Operation range	Cooling		°C	18 to 32					
	Heating		%RH	80 or less					
		°C		16 to 30					
Remote controller type				Wireless (Option: Mobile app*2 [AIRSTAGE Mobile])					

NOTES:

- The protective function might work when using it outside the operation range.
- *1: Sound pressure level:
 - These are the measured values in the manufacturer's anechoic chamber.
 - Because of the surrounding sound environment, the sound levels measured in actual installation conditions might be higher than the specified values here.
- *2: Available on Google Play™ store or on App Store®.

2-6. Floor type

Model name				AGEG09KVCA	AGEG12KVCA	AGEG14KVCA	
Power supply				230 V~ 50 Hz			
Available voltage range				198—264 V			
Capacity		kW class		2.5	3.5	4.0	
Input power		W		16	20	23	
Running current		A		0.15	0.18	0.20	
Fan	Airflow rate	Cooling	HIGH	m ³ /h	530	600	650
			MED		440	490	520
			LOW		360	380	400
			QUIET		270		
		Heating	HIGH		530	600	650
			MED		460	510	540
			LOW		380	410	430
			QUIET		270		
	Type × Qty		Crossflow fan × 2				
	Motor output		W		16 × 2		
Sound pressure level*1	Cooling	HIGH	dB (A)	39	42	44	
		MED		34	36	38	
		LOW		28	30	31	
		QUIET		22			
	Heating	HIGH		39	42	44	
		MED		35	38	39	
		LOW		30	32	33	
		QUIET		22			
Sound power level	Cooling	dB (A)	52	55	56		
	Heating		52	55	56		
Heat exchanger type	Dimensions (H × W × D)		mm	378 × 550 × 26.6			
	Fin pitch			1.2			
	Rows × Stages			2 × 18			
	Pipe type			Copper tube			
	Fin type			Aluminum			
Enclosure	Material		Polystyrene				
	Color		White Approximate color of Munsell N 9.25/				
Dimensions (H × W × D)	Net		mm	600 × 740 × 200			
	Gross			700 × 820 × 310			
Weight	Net		kg	14			
	Gross			18			
Connection pipe	Size	Liquid	mm (in)	Ø6.35 (Ø1/4)			
		Gas		Ø9.52 (Ø3/8)			
	Method			Flare			
Drain hose	Material		Polypropylene + Linear low-density polyethylene				
	Tip diameter		mm Ø13.8 (I.D.), Ø15.8 to Ø16.7 (O.D.)				
Operation range	Cooling	°C	18 to 32				
		%RH	80 or less				
	Heating	°C	30 or less				
Remote controller type				Wireless (Option: Wired, Mobile app*2 [FGLair™])			
NOTES: <ul style="list-style-type: none"> The protective function might work when using it outside the operation range. *1: Sound pressure level: <ul style="list-style-type: none"> These are the measured values in the manufacturer's anechoic chamber. Because of the surrounding sound environment, the sound levels measured in actual installation conditions might be higher than the specified values here. *2: Available on Google Play™ store or on App Store®. Optional WLAN Adapter is also required. For details, refer to the setting manual. 							

3. Wireless LAN control (for KMCG, KMCG-B, KETF, KETF-B, KGTG, and KNCA)

By installing mobile app on a smart device, several functions can be controlled from outside the house.

3-1. System requirement

Before using this function, prepare the following items:

- **Wireless router:**

Wireless LAN standard	IEEE802.11b/g/n
Frequency bands*	<ul style="list-style-type: none"> • U.S.A., Canada: 2.4 GHz (1ch—11ch) • Other countries: 2.4 GHz (1ch—13ch)
Network security standard	<ul style="list-style-type: none"> • Open • WEP • WPA (PSK) • WPA2 Personal (PSK) • WPS for same-LAN registration

*: Usable only in the country or region where you purchased the product.

To check whether your wireless router complies with the network security standards listed above, refer to the operation manual.

- **Smartphone:**

App-compliant operating system	iOS	Check the latest version of supported OS at Google Play store or App Store.
	Android™	

- **AIRSTAGE Mobile (mobile application):**

Mobile app is available on Google Play store or on App Store.

After installation of mobile app, user registration is required. For user registration and setup information, refer to Setting Manual attached with the product.

For the latest version of the wireless LAN control manuals, refer to the following web site.

<https://www.fujitsu-general.com/global/support/>

4. Dimensions

4-1. Compact cassette type

■ Models: AUXG07-14KVLA

Unit: mm

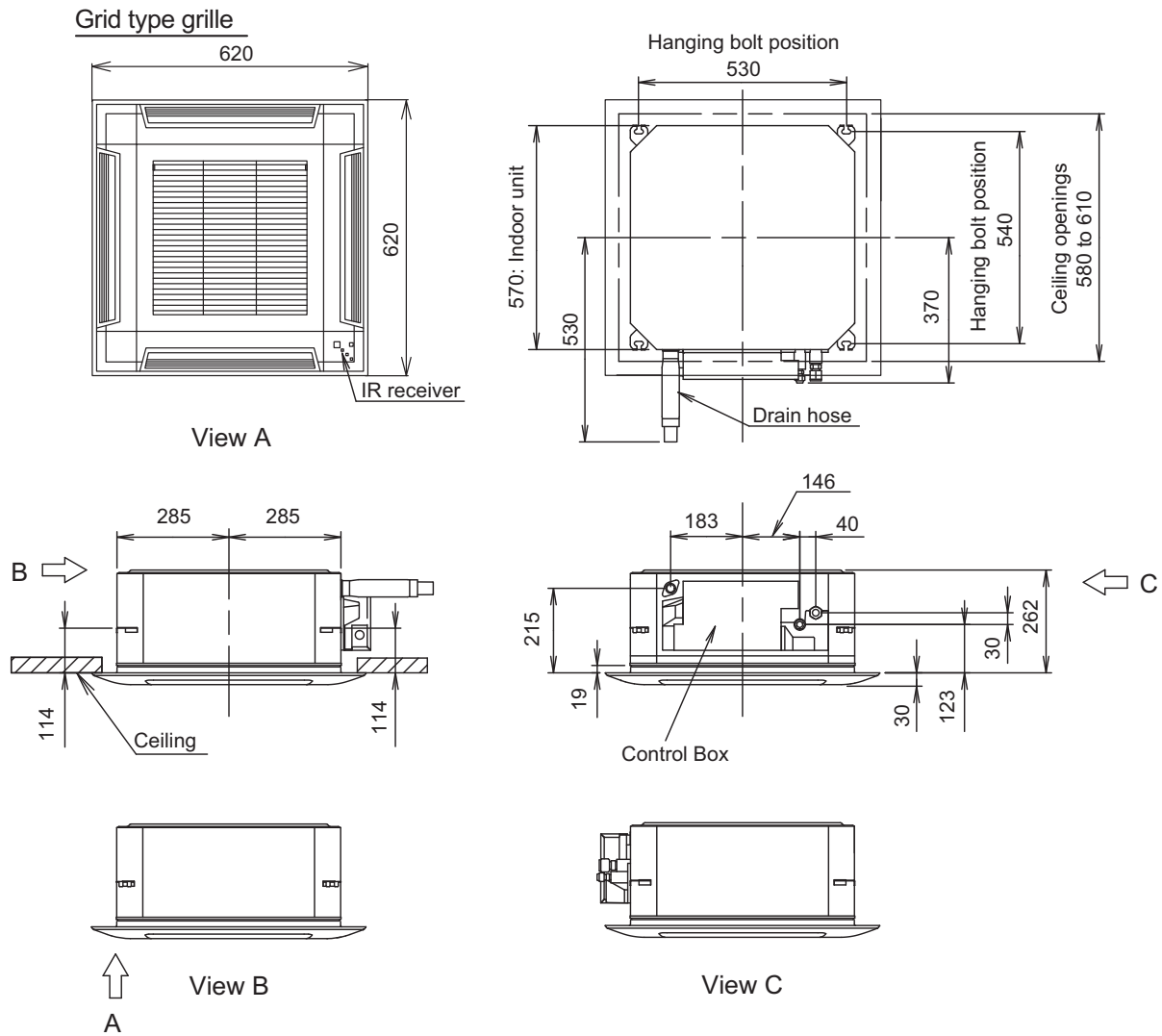

● Installation space requirement

Unit: mm

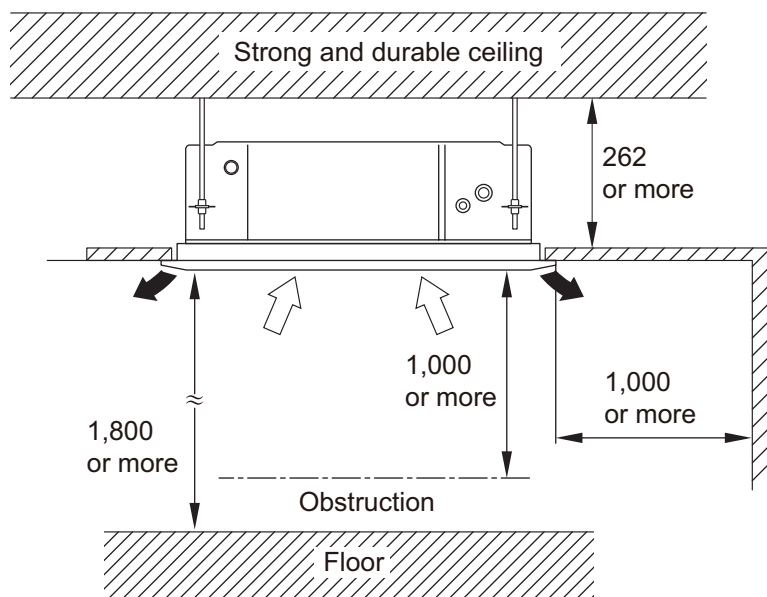

Maximum height from floor to ceiling (Unit: mm)		
	07 and 09 models	12 or larger models
Standard	2,700	
High ceiling	—	3,000

● 3-way direction setting

Unit: mm

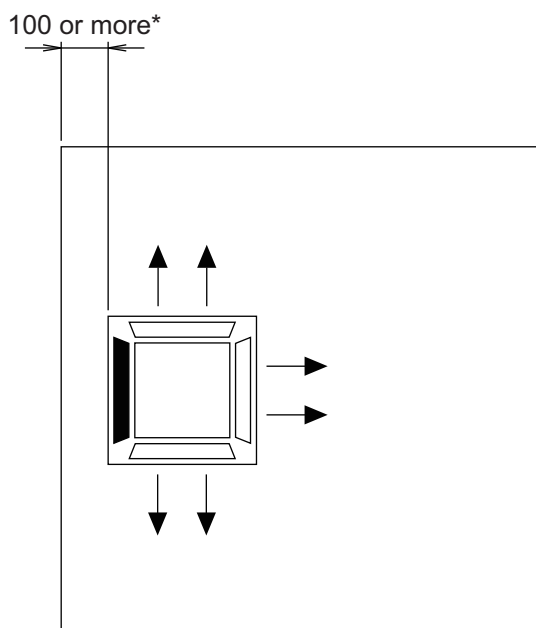

NOTES:

- To set "3-direction", optional Air Outlet Shutter Plate (UTR-YDZB) must be installed, and the "outlet-direction" need to be switched to "3-way" by remote controller.
*When installing the indoor unit, be careful about the maintenance space.
- In 3-way outlet mode, changing of ceiling height setting by function setting 20 is prohibited. (Ceiling height setting [function setting 20] is allowed to be changed only in 4-way outlet mode.)

4-2. Mini duct type

■ Models: ARXG07-14KSLAP

Unit: mm

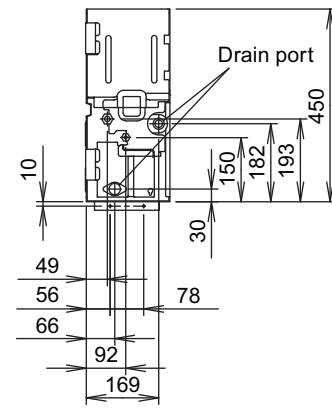
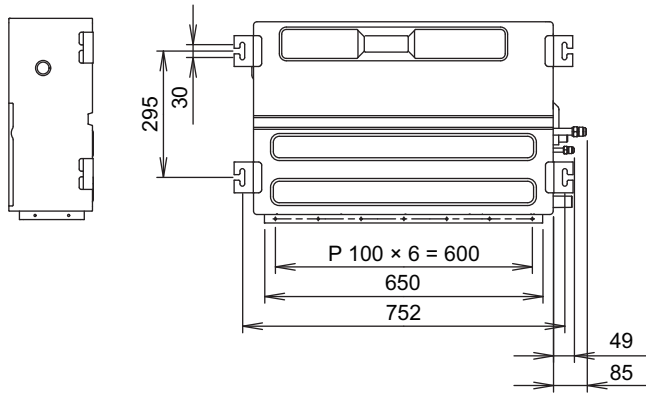
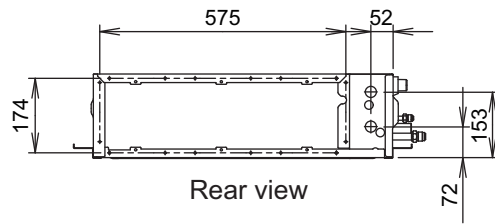

Side view (L)

Top view

Side view (R)

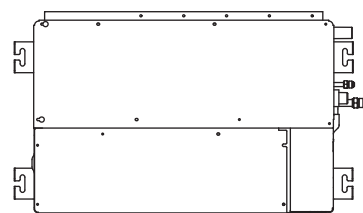
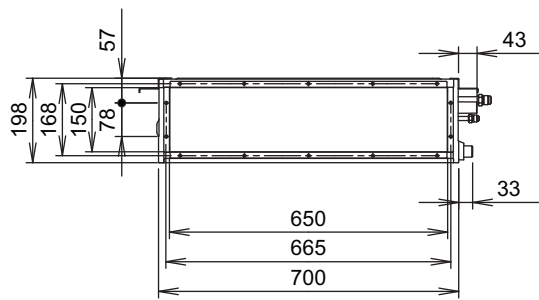

Bottom view

● Installation space requirement

Provide sufficient installation space for product safety.

Unit: mm

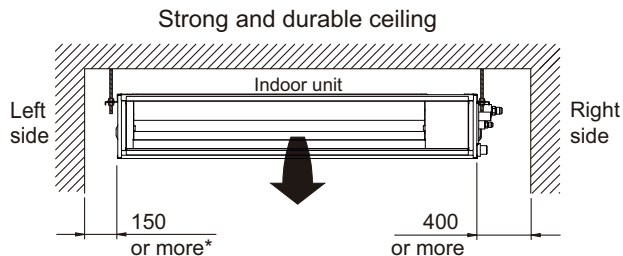

*: 400 or more when drain from drain pipe

• When intaking air from back:

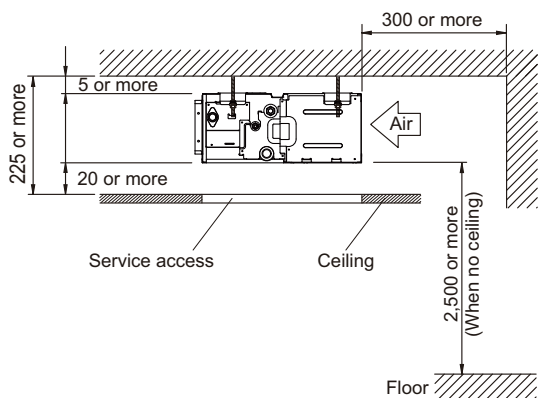

• When intaking air from bottom:

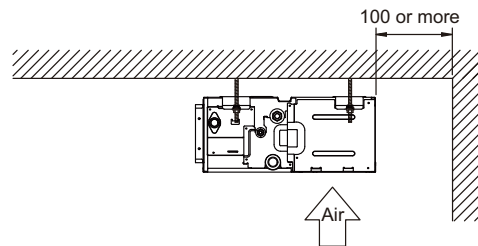

● Maintenance space requirement

Provide sufficient maintenance space for efficient maintenance.

NOTE: Do not place any wiring or illumination in the maintenance space, as they will impede service.

Unit: mm

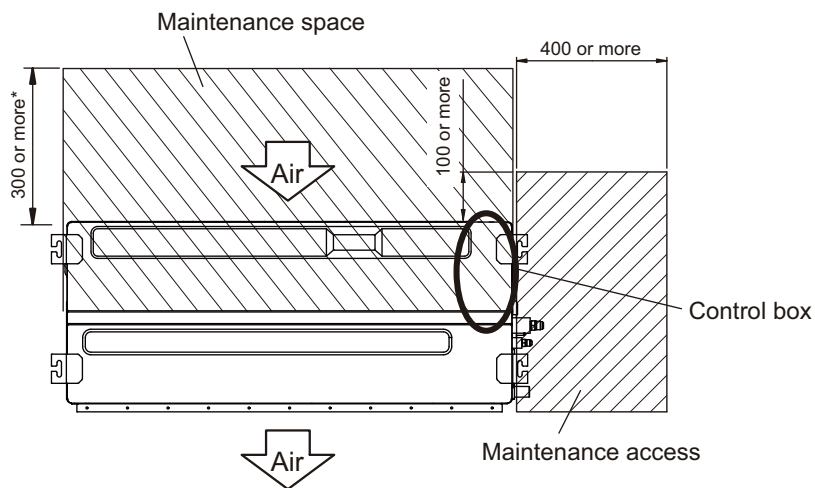

*: More than 100 when intaking air from bottom

Top view

4-3. Slim duct type

Models: ARXG07-14KLLAP

Unit: mm
Unit: mm

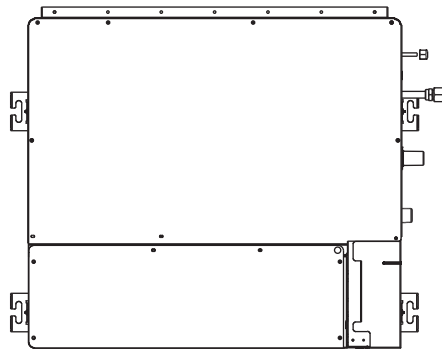
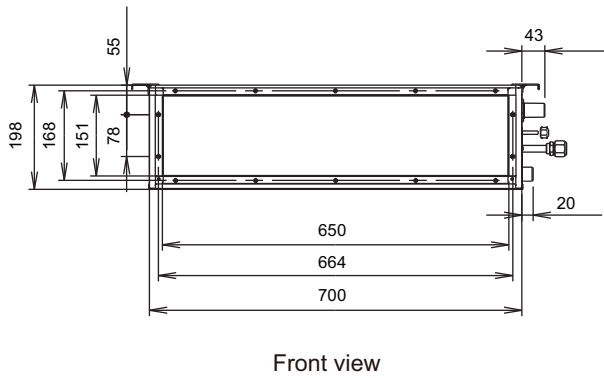
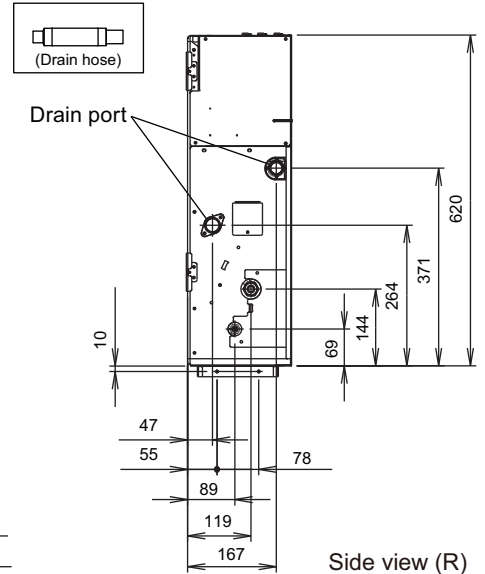
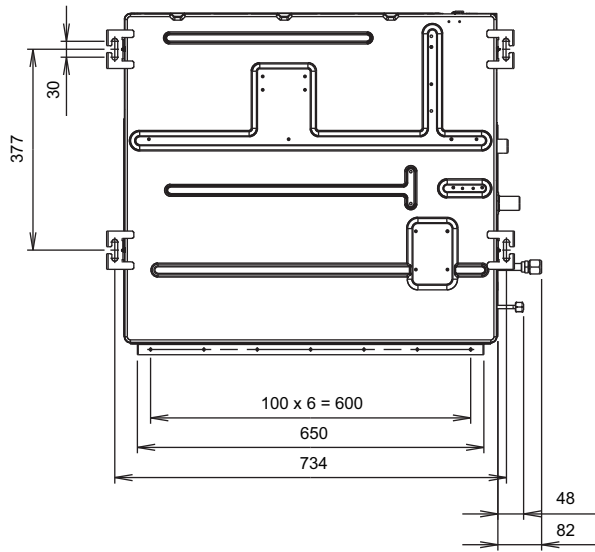
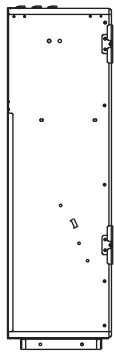
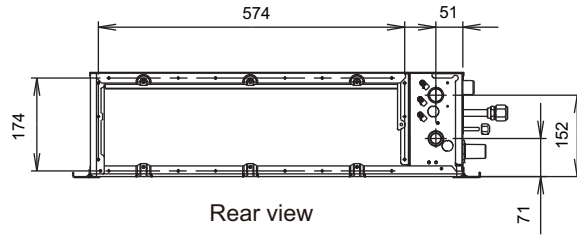

● Installation space requirement

Provide sufficient installation space for product safety.

In ceiling-concealed installations:

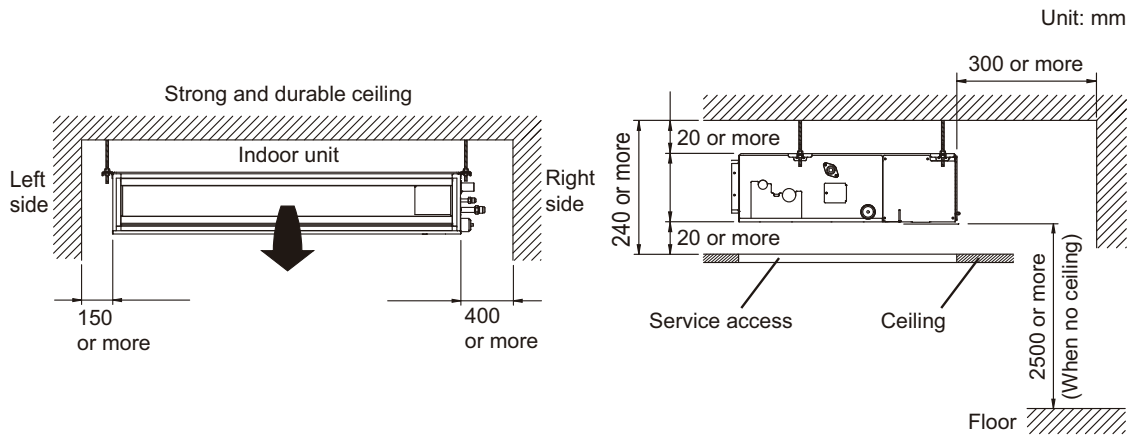

● Maintenance space requirement

Provide sufficient maintenance space for efficient maintenance.

NOTE: Do not place any wiring or illumination in the maintenance space, as they will impede service.

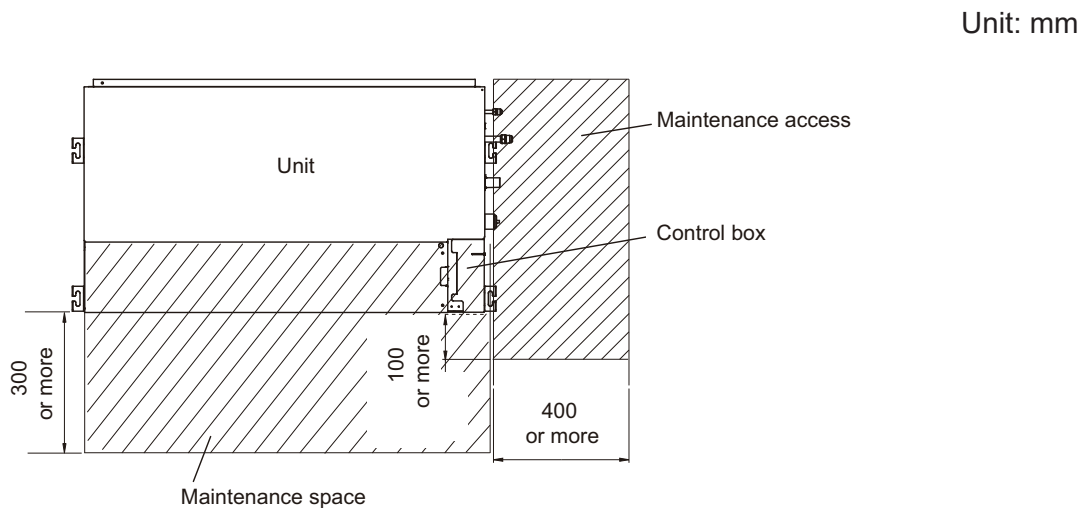

4-4. Medium static pressure duct type

■ Models: ARXH12-14KMTAP

Unit: mm

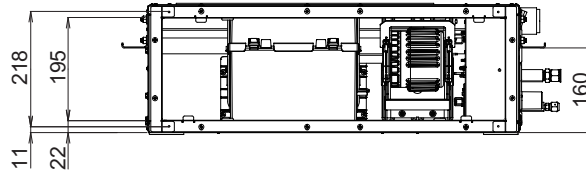

Rear view

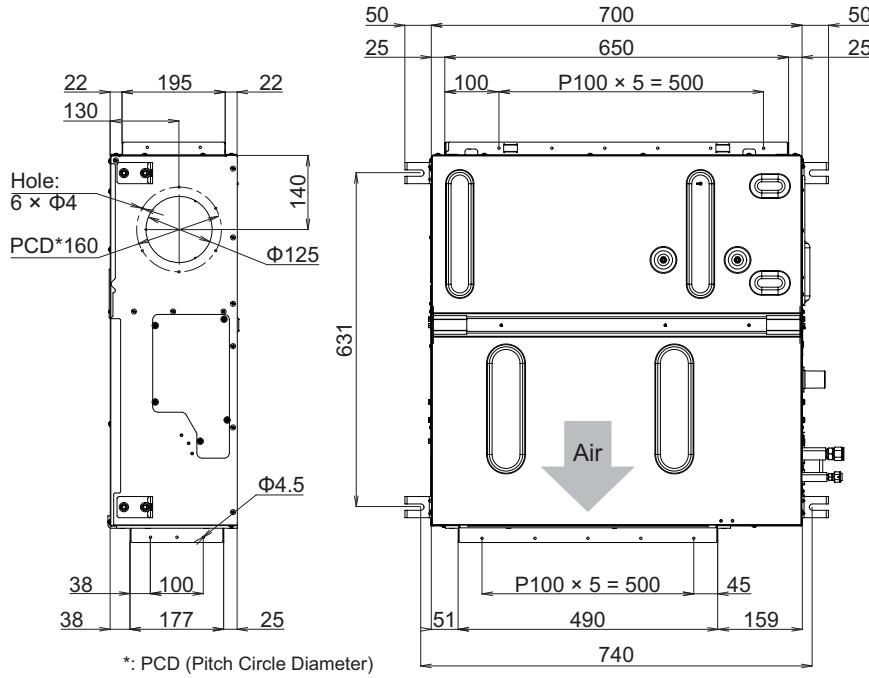

Side view (L)

Top view

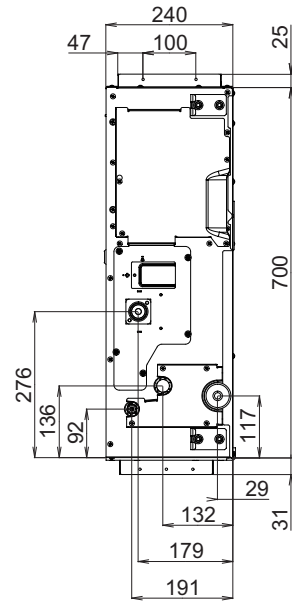

Side view (R)

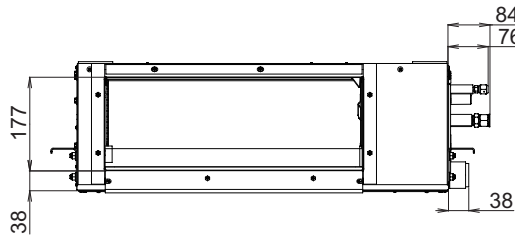

Front view

*: PCD (Pitch Circle Diameter)

● Installation space requirement

Unit: mm

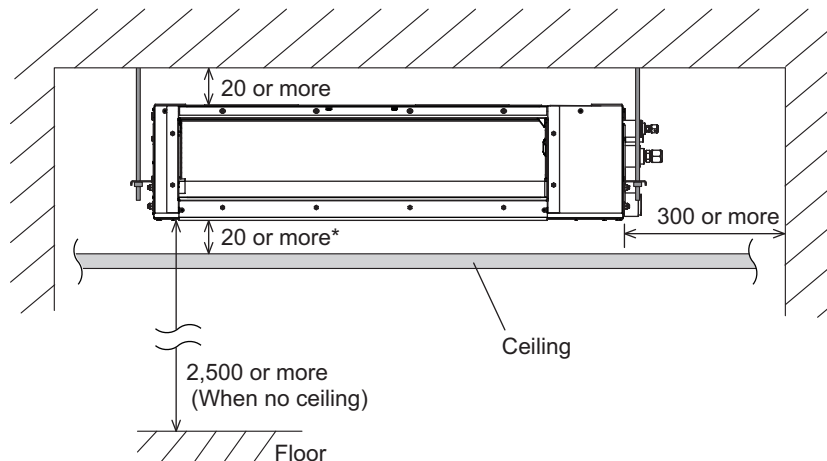

*: According to the distance between the ceiling and the unit, the construction plan of the maintenance access differs.

● Maintenance space requirement

Provide one or two maintenance accesses for the fan units and the filters or the inspections of the control box, drain pump, and the other parts.

Numbers and the sizes of the maintenance accesses differ according to the distance between the ceiling and the unit as follows.

Unit: mm

- Distance between the ceiling and the unit is 300 or more:

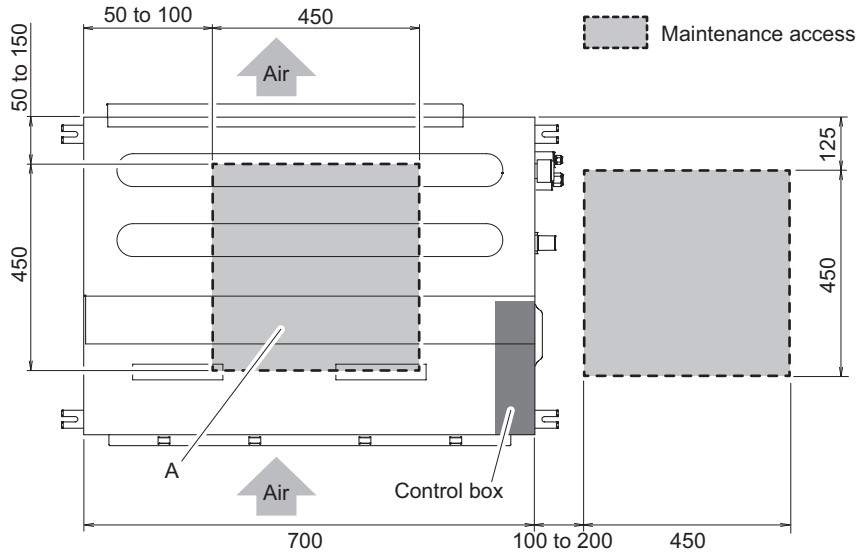

Bottom view

NOTE: If there is sufficient working space between the indoor unit and the ceiling plate, the maintenance access under the unit (A) is not necessary.

- Distance between the ceiling and the unit is from 20 to 300:
Choose one of these methods to set up the maintenance access.

Pattern A

 Maintenance access

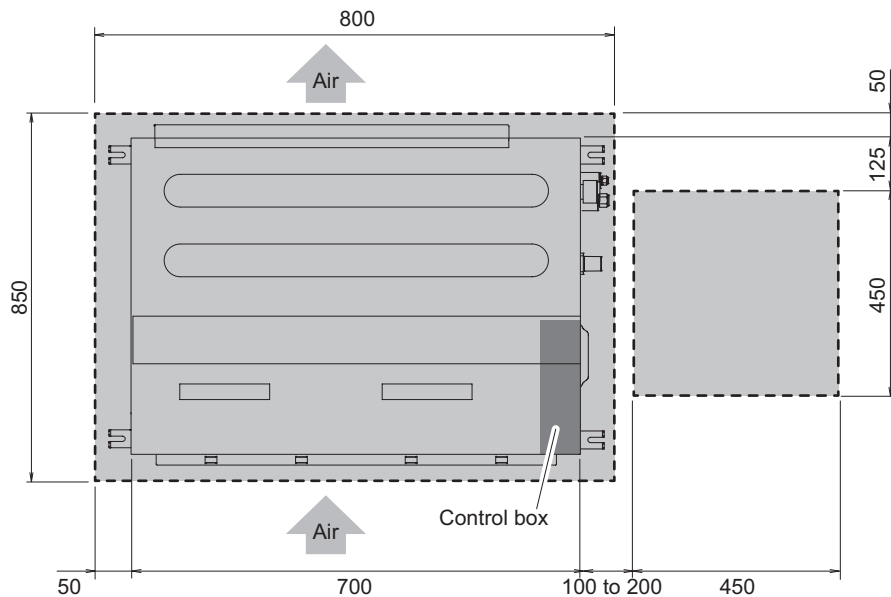

Pattern B

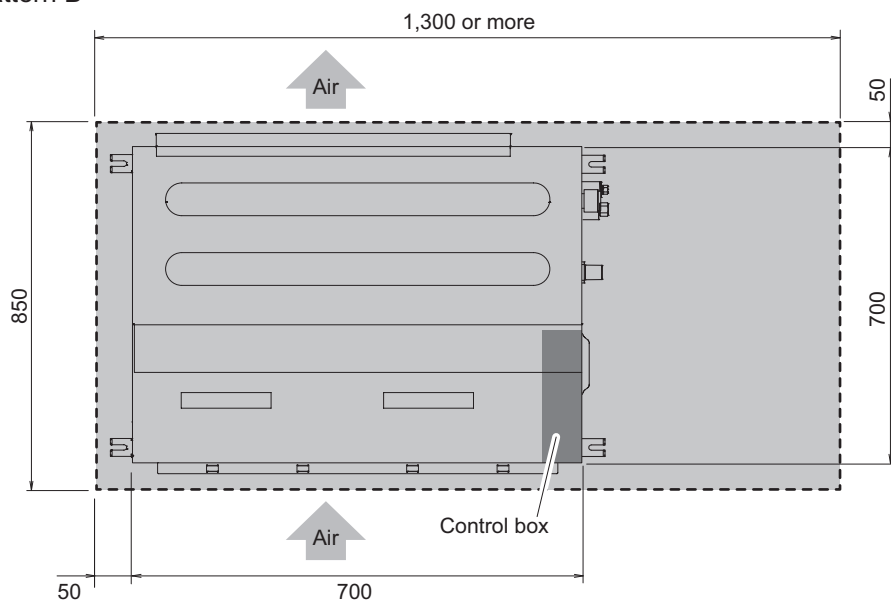

Bottom view

4-5. Wall mounted type

■ Models: ASEH07-14KMCG and ASEH07-14KMCG-B

Unit: mm

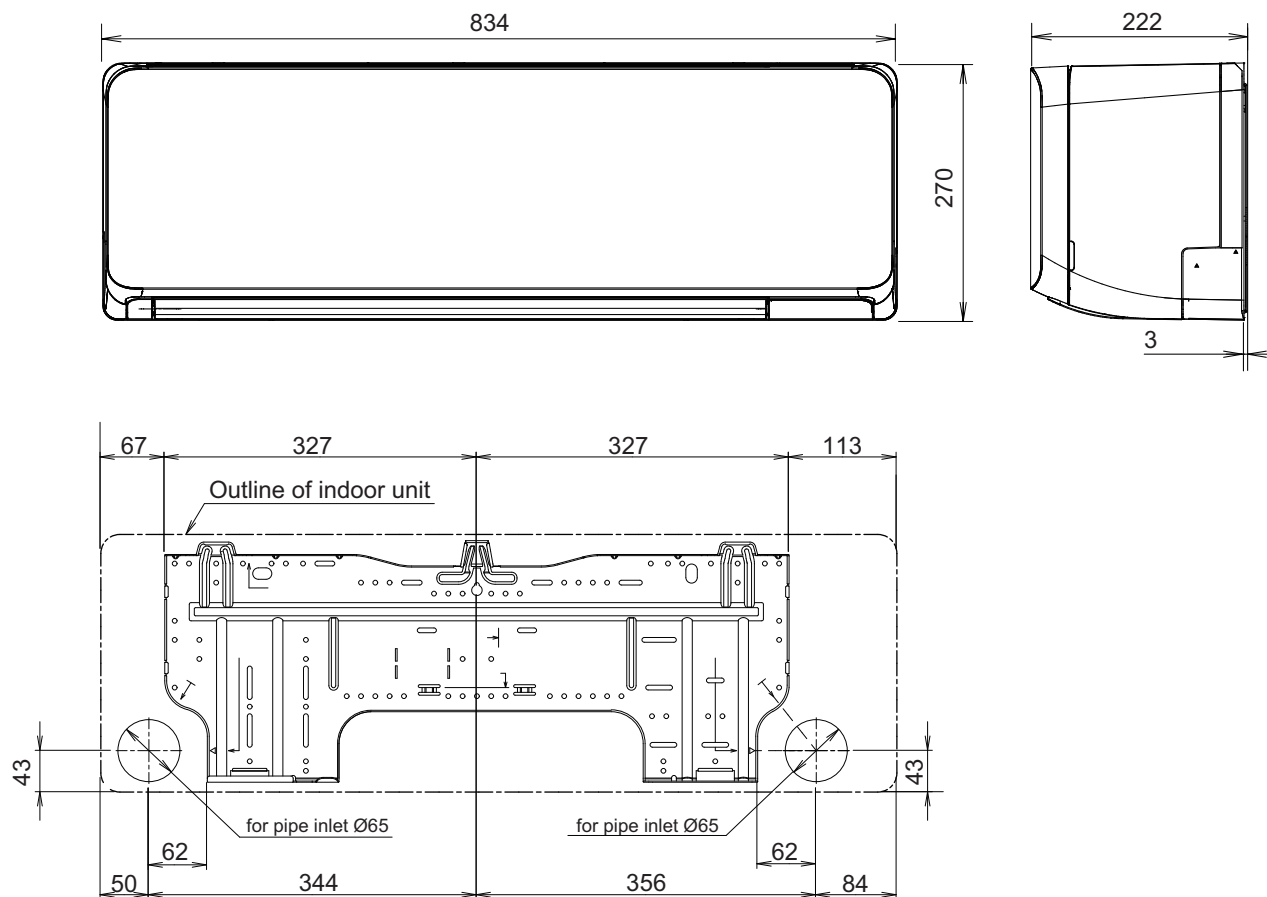

● Installation space requirement

Provide sufficient installation space for product safety.

Unit: mm

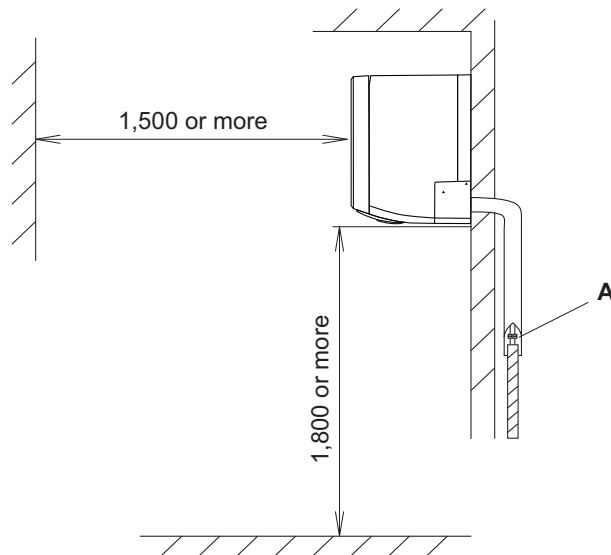
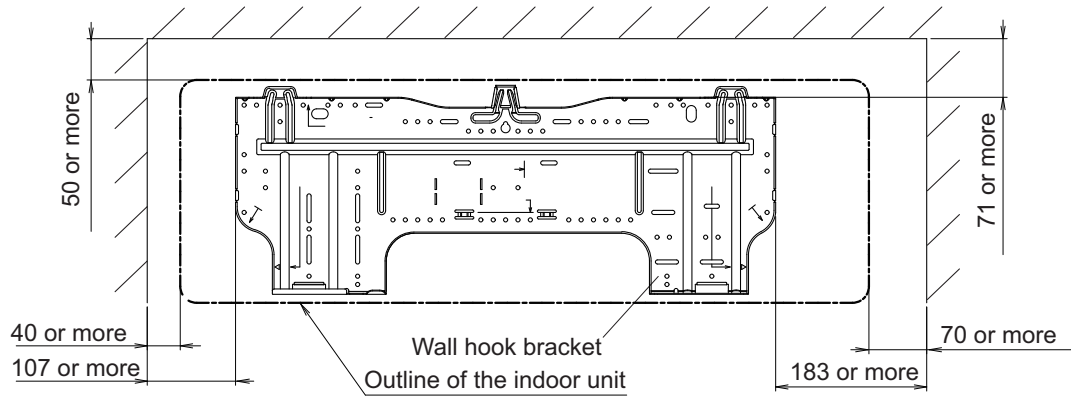

A: Install so that the flare connection part is outdoors.

■ Models: ASEG07-14KETF and ASEG07-14KETF-B

Unit: mm

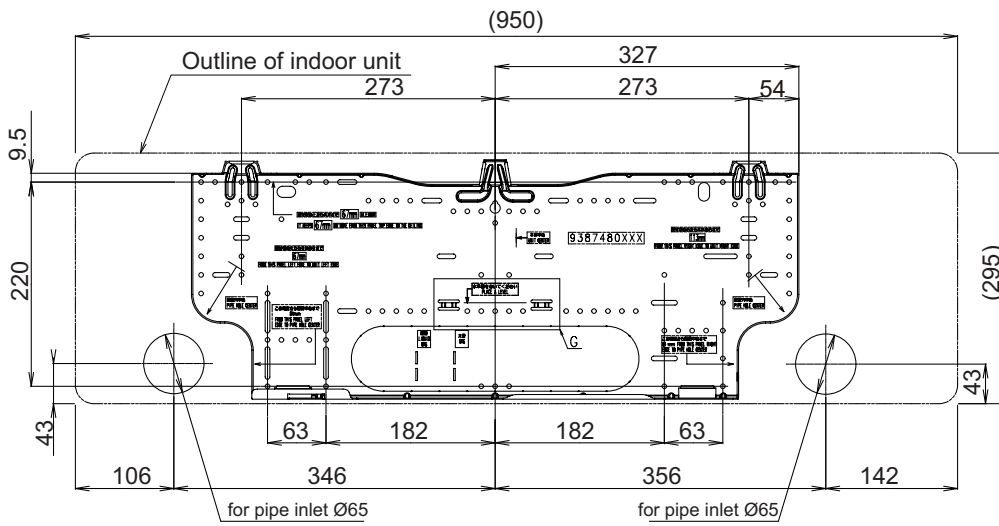
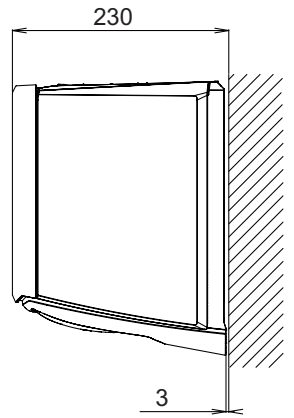
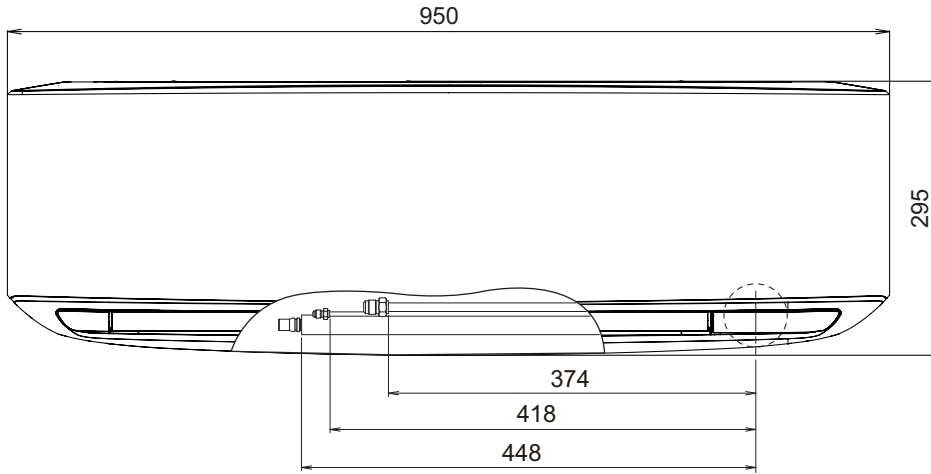

2-UNIT
MULTI-SPLIT TYPE

2-UNIT
MULTI-SPLIT TYPE

● Installation space requirement

Provide sufficient installation space for product safety.

Unit: mm

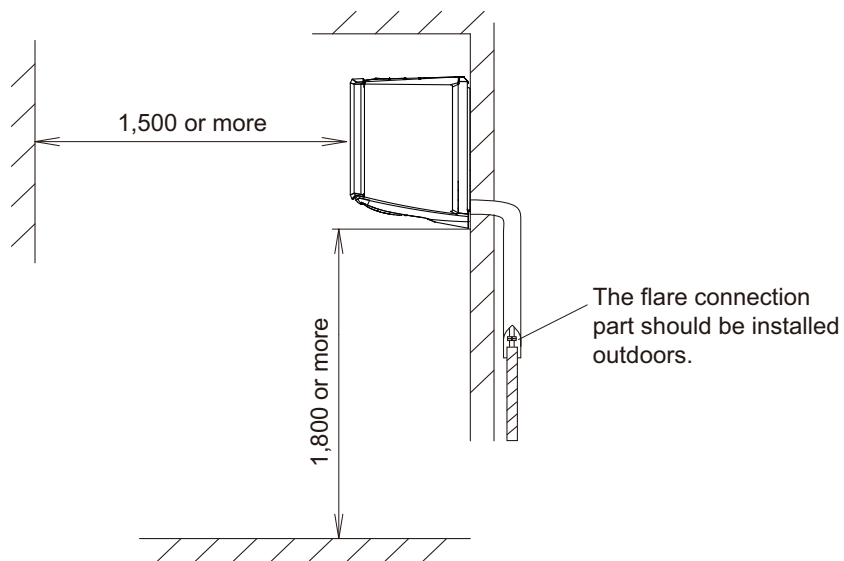
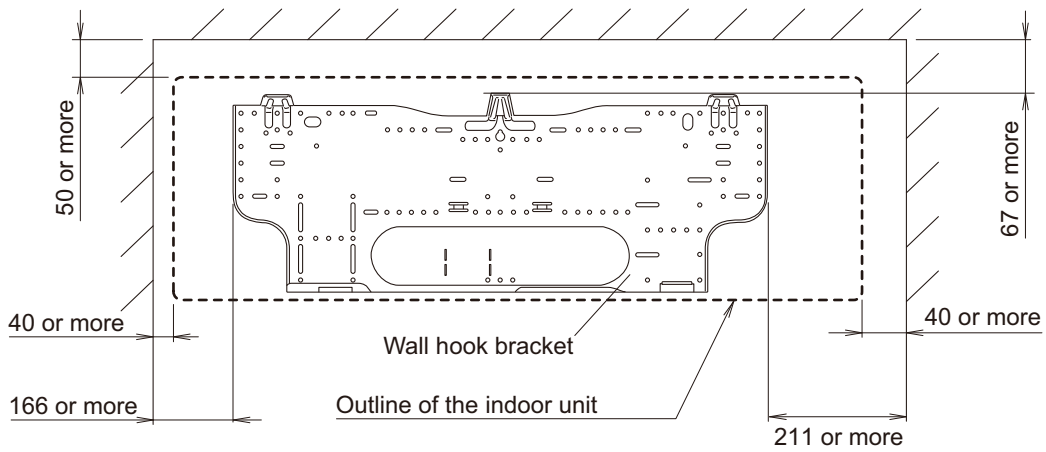

■ ASEH07-14KGTG

2-UNIT
MULTI-SPLIT TYPE

2-UNIT
MULTI-SPLIT TYPE

Unit: mm

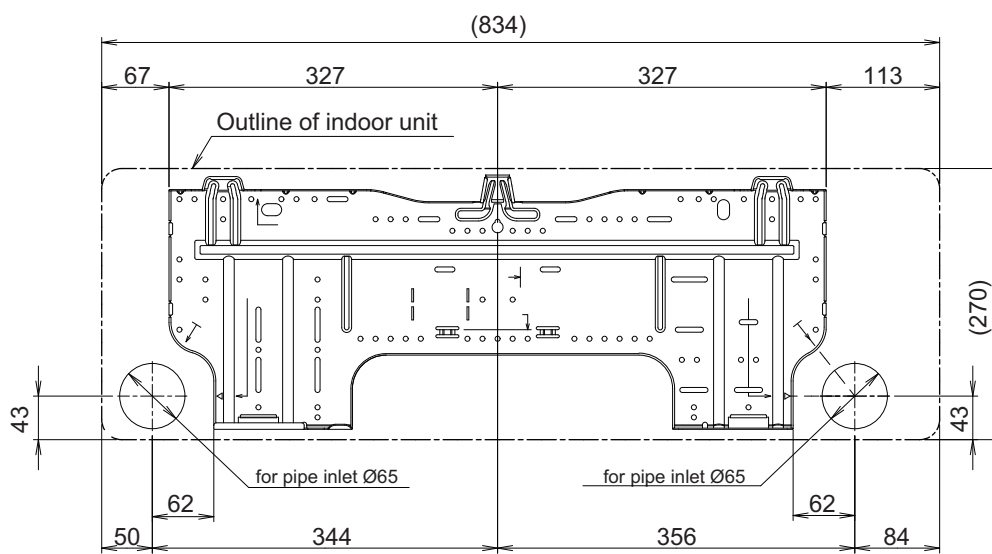
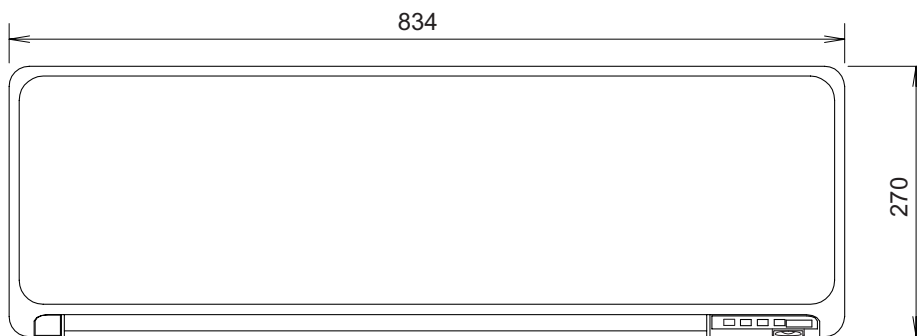

● Installation space requirement

Provide sufficient installation space for product safety.

Unit: mm

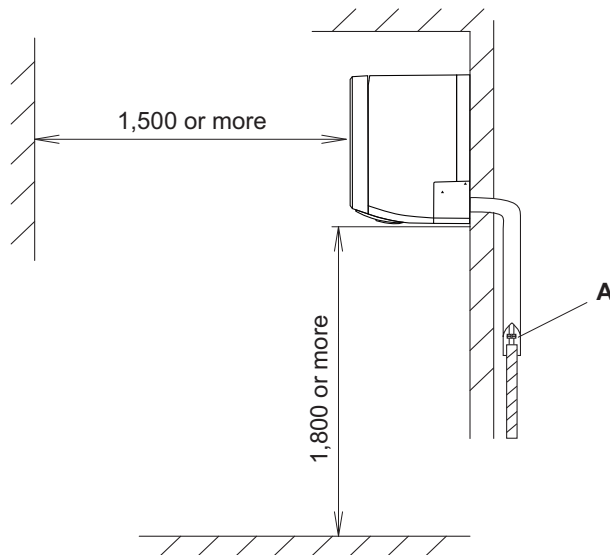
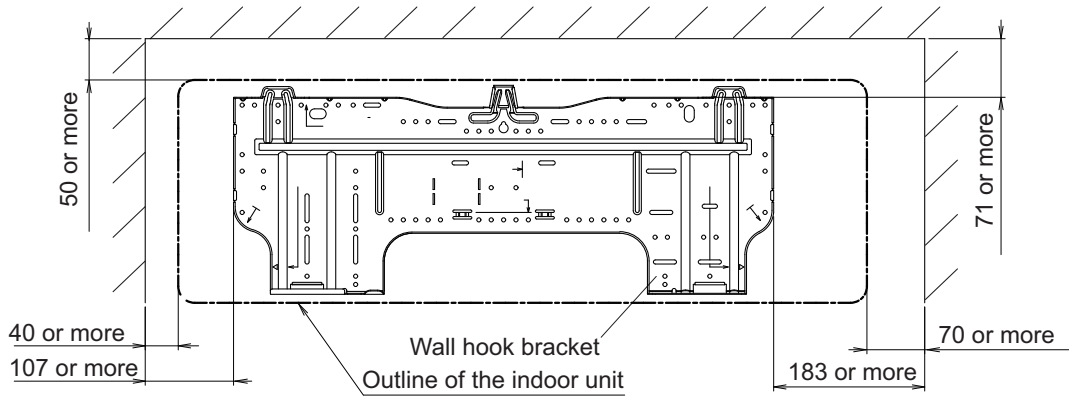

A: Install so that the flare connection part is outdoors.

■ Models: ASEH05-12KNCA

Unit: mm

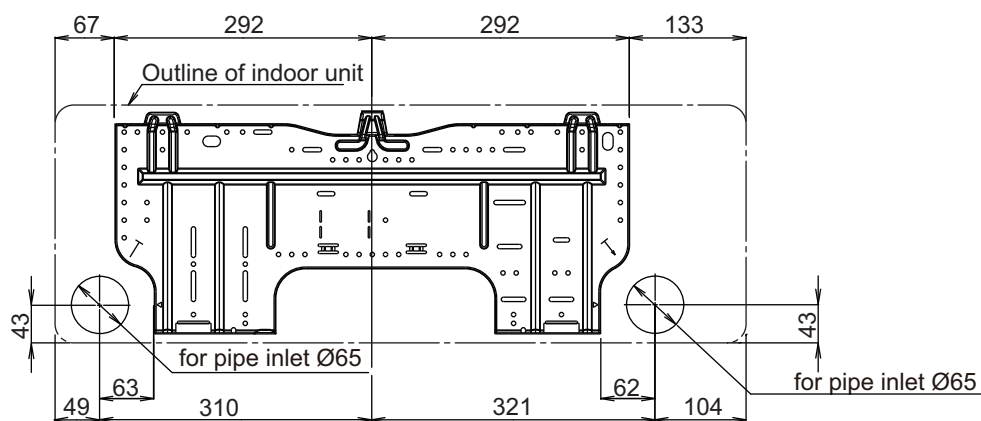
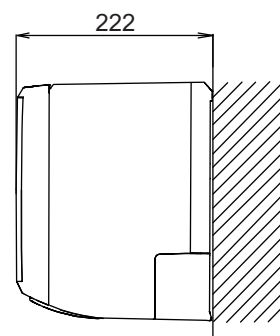
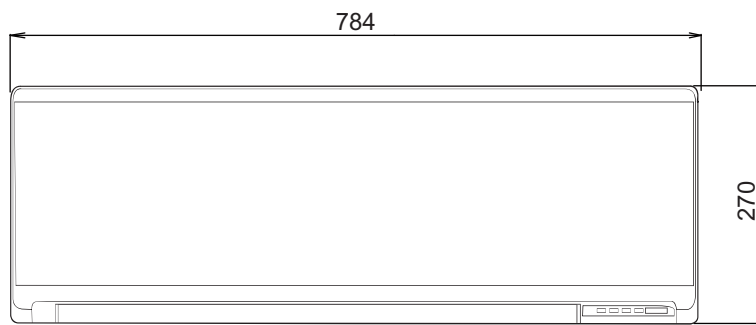

● Installation space requirement

Provide sufficient installation space for product safety.

Unit: mm

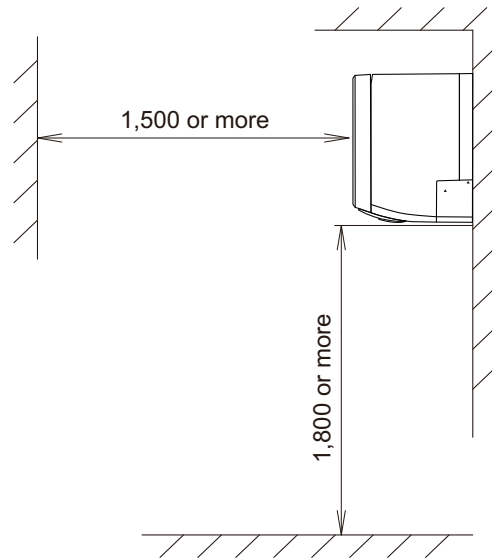
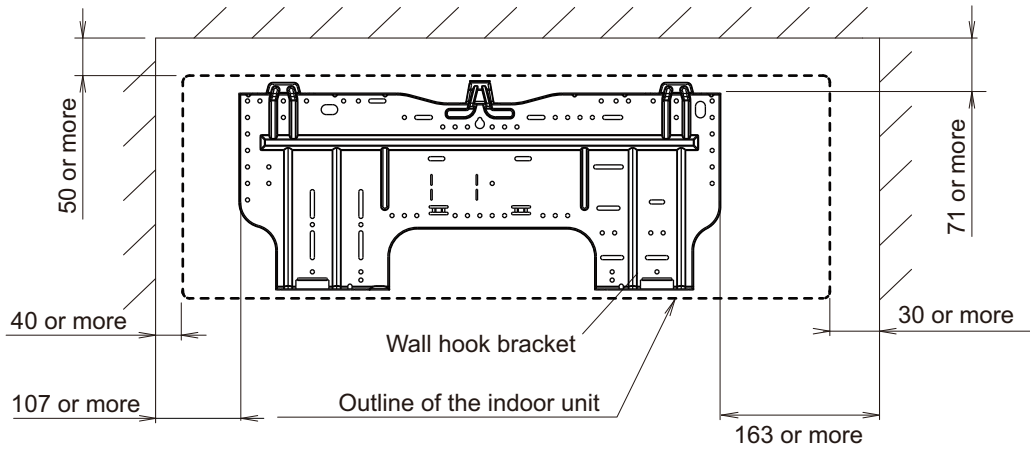

■ Pipe exit length from the rear (for KMCG, KMCG-B, KGTG, and KNCA)

Design the system considering the length of the pipes or hose exiting from the rear of the indoor unit.

NOTE: Detailed shapes of the indoor unit and the tip of each pipe or hose may vary depending on the model.

Unit: mm

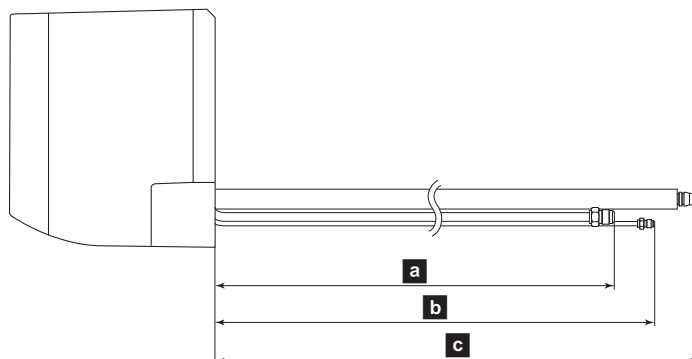

Model name	Approximate length		
	a Gas pipe	b Liquid pipe	c Drain hose
ASEH07-14KMCG ASEH07-14KMCG-B	395	435	480
ASEH07-14KGTG	380	430	480
ASEH05-12KNCA	380	430	485

4-6. Floor type

■ Models: AGEG09-14KVCA

Unit: mm

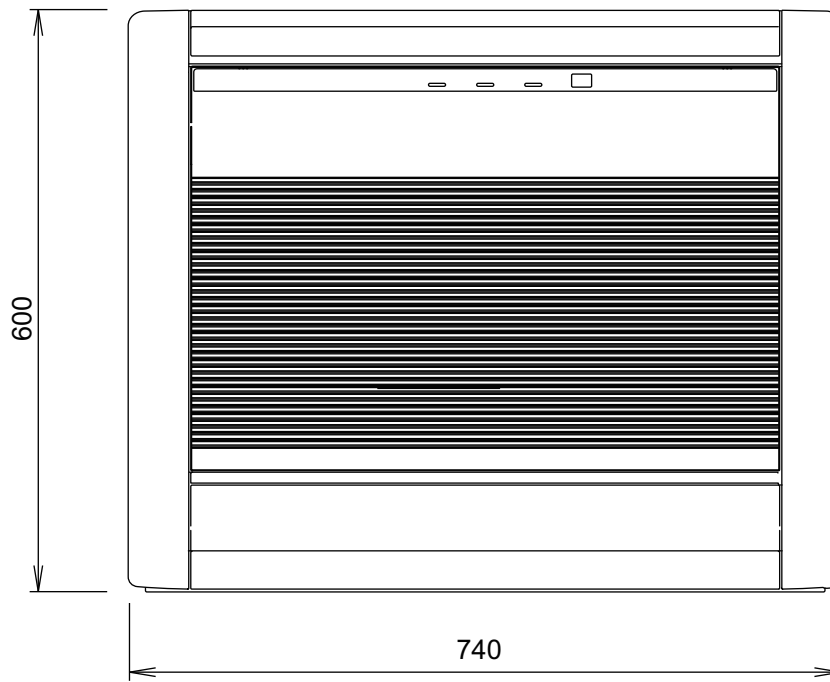

Front view

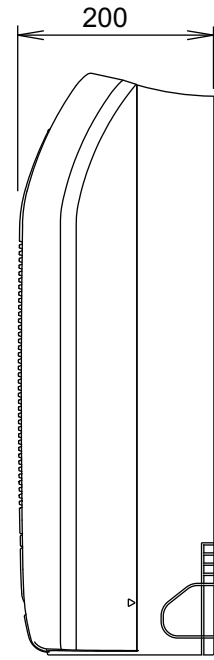

Side view

● Installation space

Unit: mm

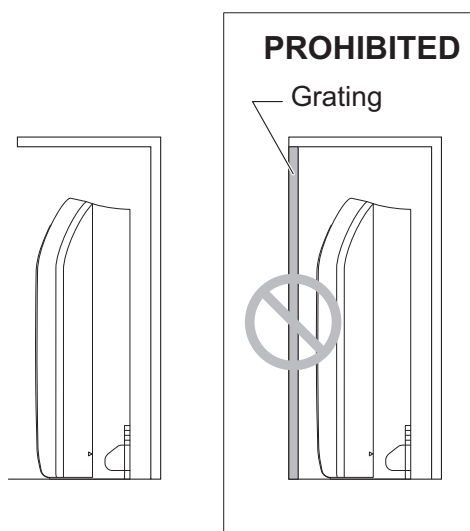
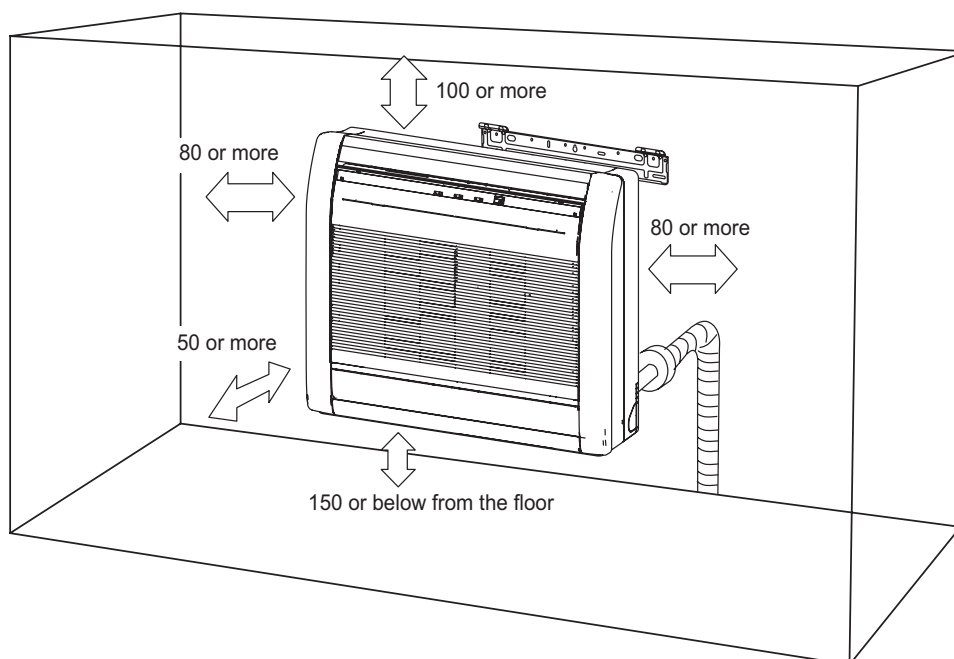

⚠ WARNING

- The appliance shall be installed, operated and stored in a room with a floor area larger than X m².

Amount of refrigerant charge M (kg)	Minimum room area X (m ²)
$M \leq 1.22$	-
$1.22 < M \leq 1.23$	12.99
$1.23 < M \leq 1.50$	19.31
$1.50 < M \leq 1.75$	26.28
$1.75 < M \leq 2.0$	34.33
$2.0 < M \leq 2.5$	53.63
$2.5 < M \leq 3.0$	77.23
$3.0 < M \leq 3.5$	105.12
$3.5 < M \leq 4.0$	137.29

(IEC 60335-2-40)

5. Wiring diagrams

5-1. Compact cassette type

Models: AUXG07-14KVLA

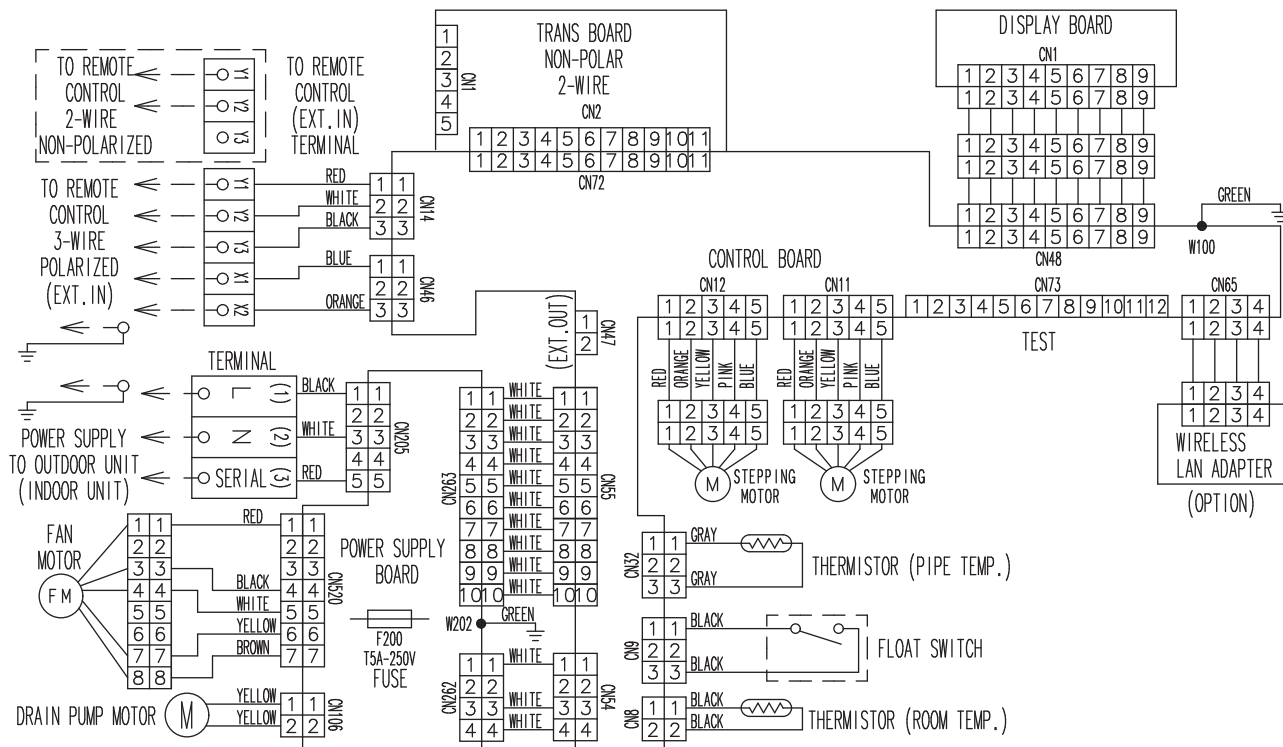

5-2. Mini duct type and Slim duct type

Models: ARXG07-14KSLAP and ARXG07-14KLLAP

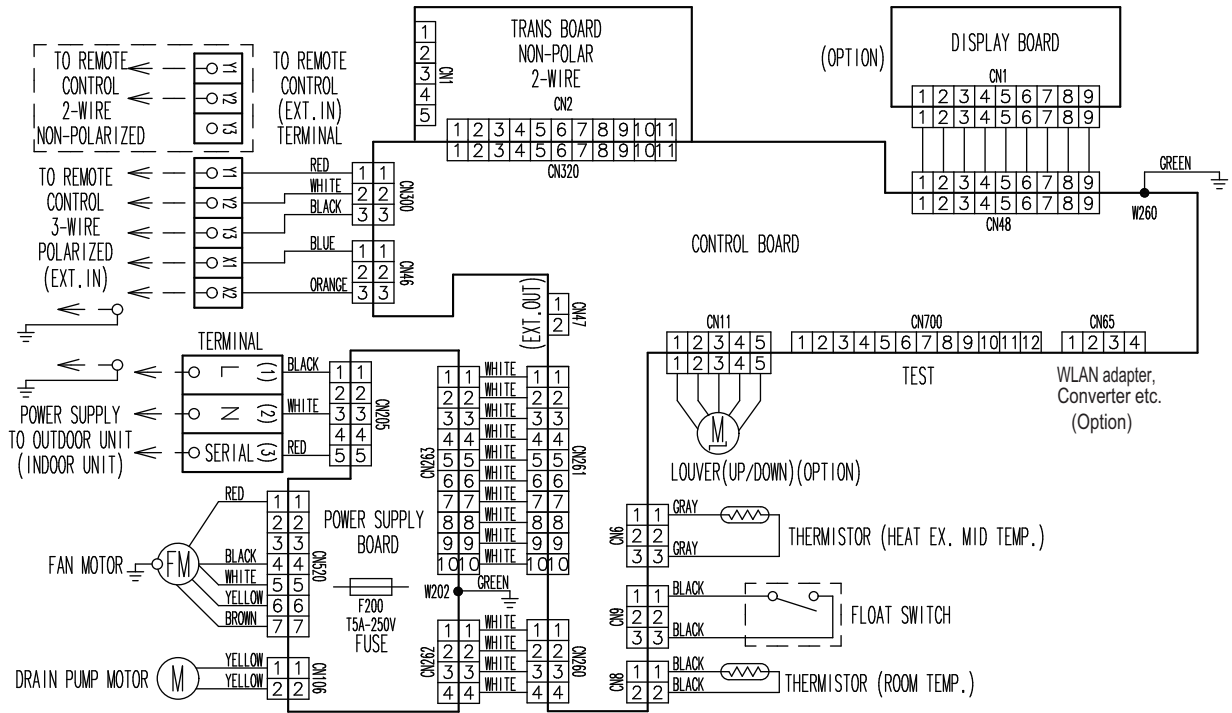

5-3. Medium static pressure duct type

Models: ARXH12-14KMTAP

2-UNIT MULTI-SPLIT TYPE

2-UNIT MULTI-SPLIT TYPE

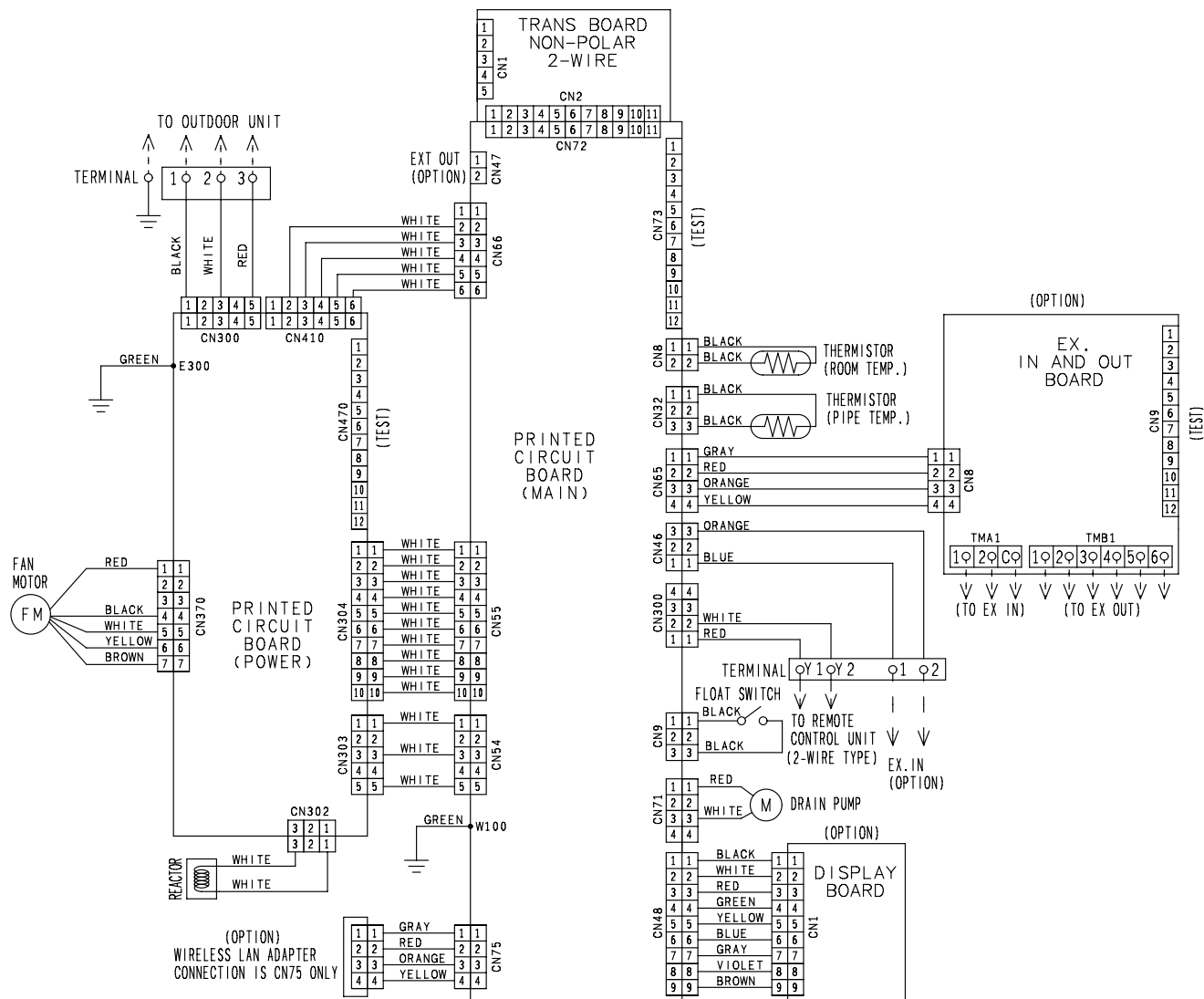

5-4. Wall mounted type

■ Models: ASEH07-14KMCG and ASEH07-14KMCG-B

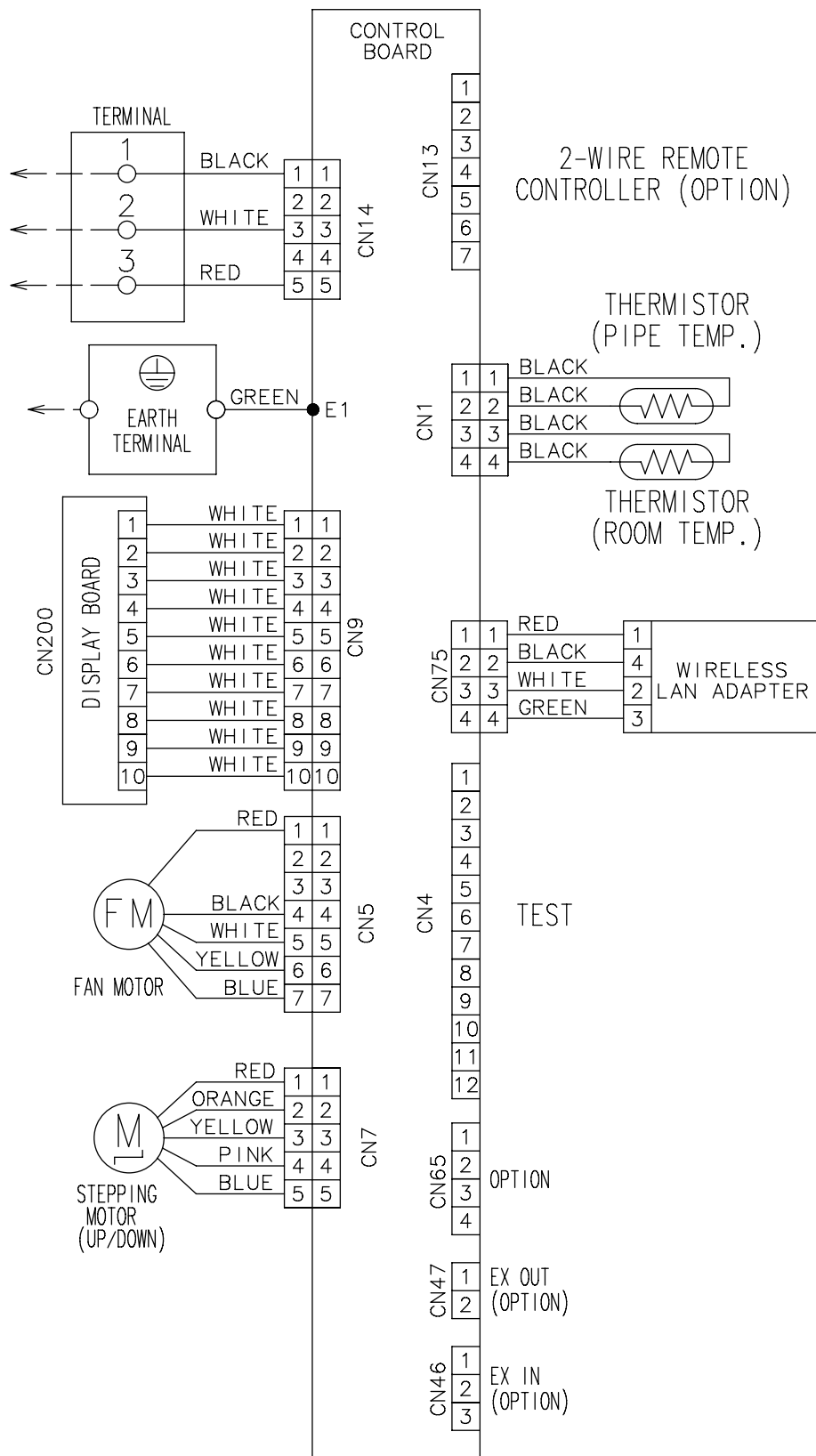

■ Models: ASEG07-14KETF and ASEG07-14KETF-B

2-UNIT
MULTI-SPLIT TYPE

2-UNIT
MULTI-SPLIT TYPE

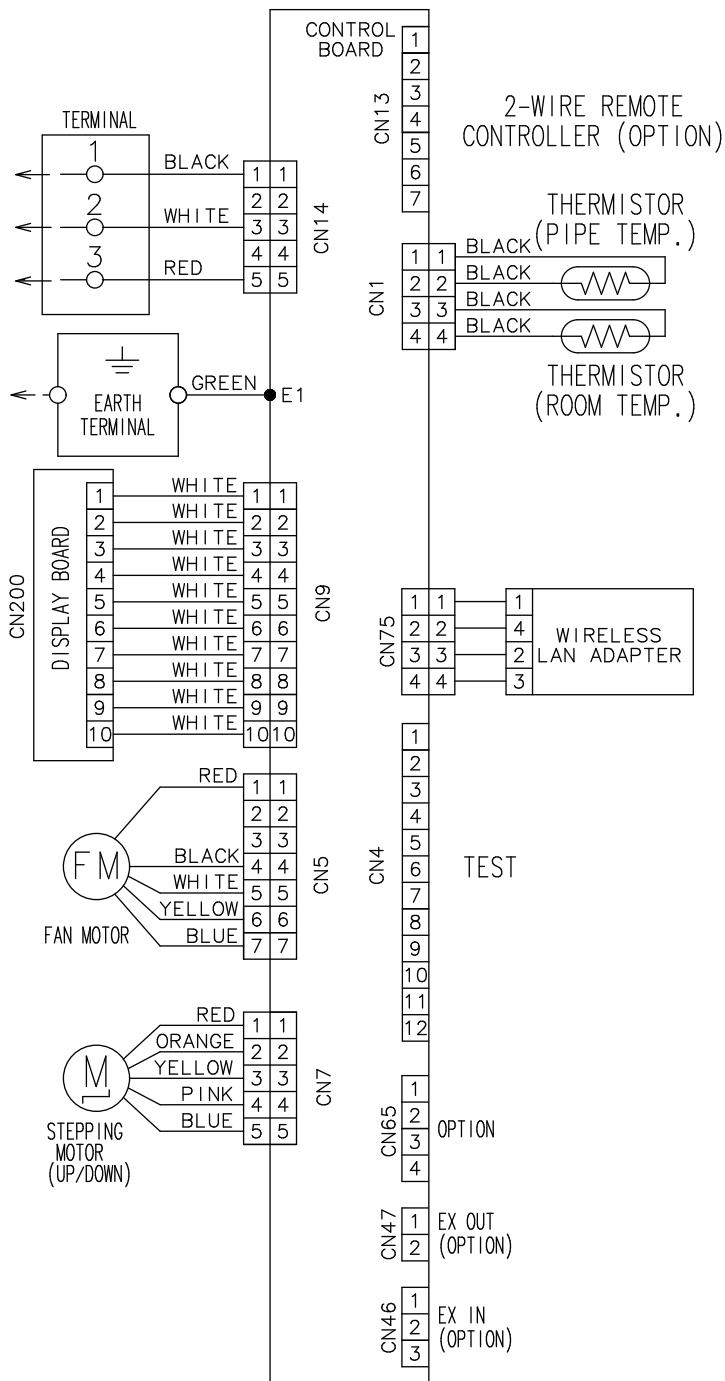

Models: ASEH07-14KGTG

2-UNIT
MULTI-SPLIT TYPE

2-UNIT
MULTI-SPLIT TYPE

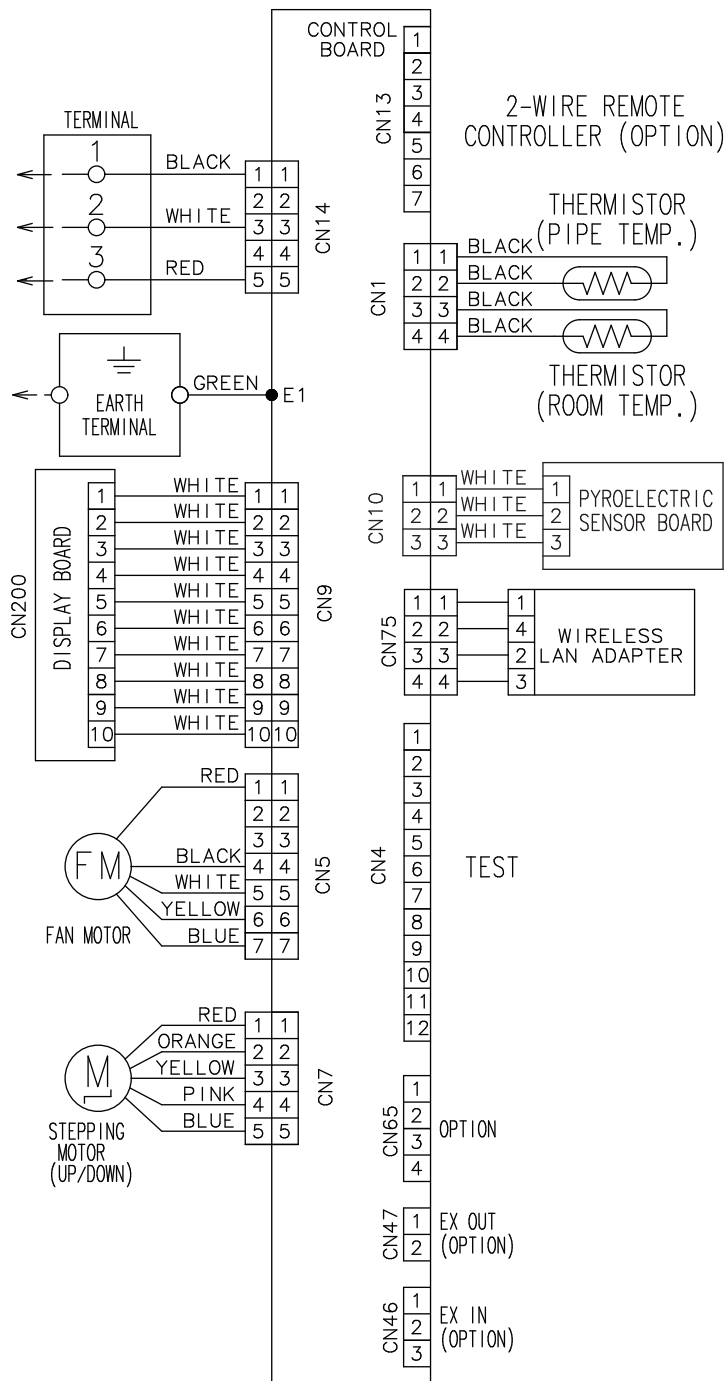

■ Models: ASEH05-12KNCA

2-UNIT
MULTI-SPLIT TYPE

2-UNIT
MULTI-SPLIT TYPE

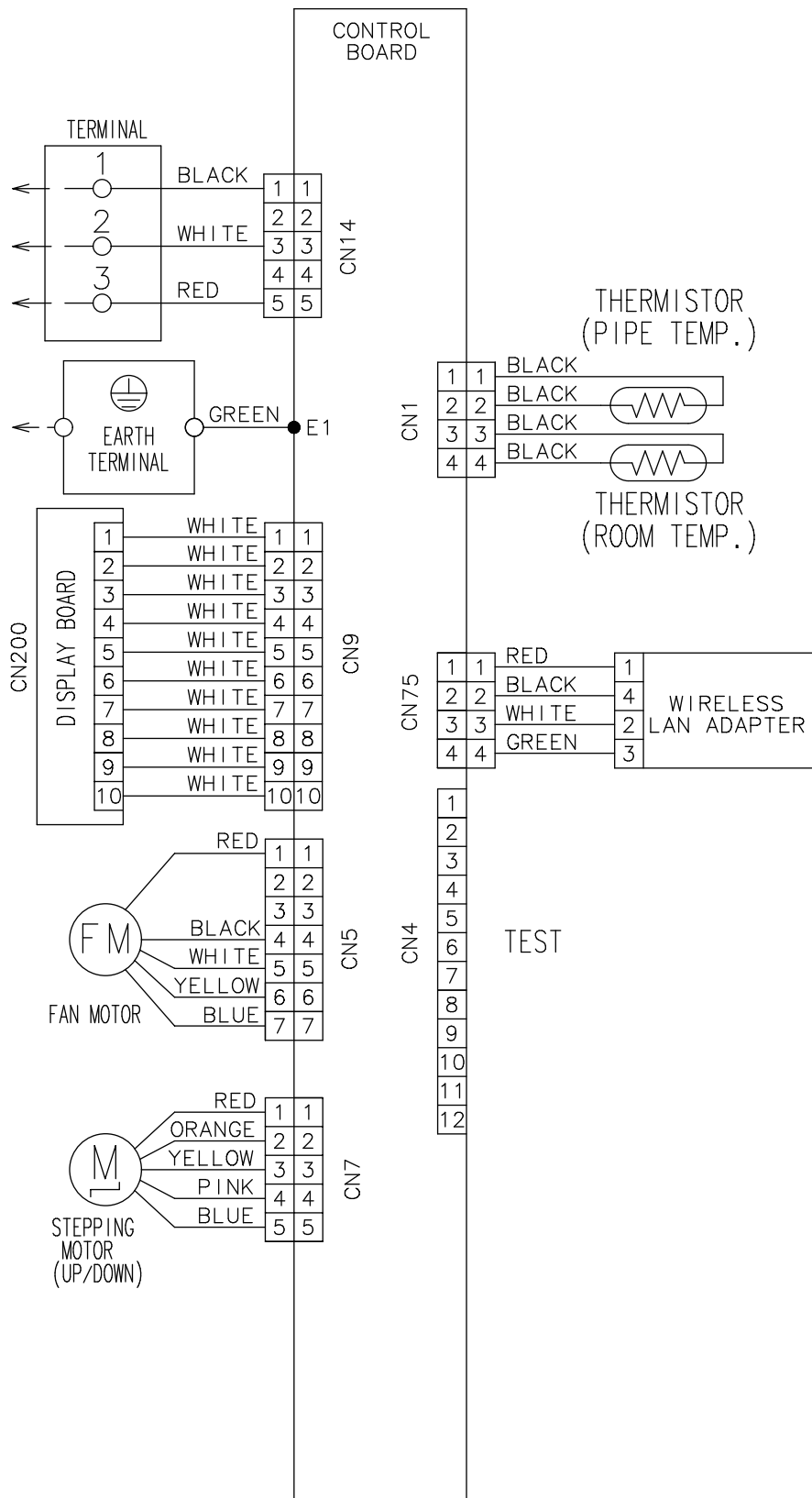

5-5. Floor type

Models: AGEG09-14KVCA

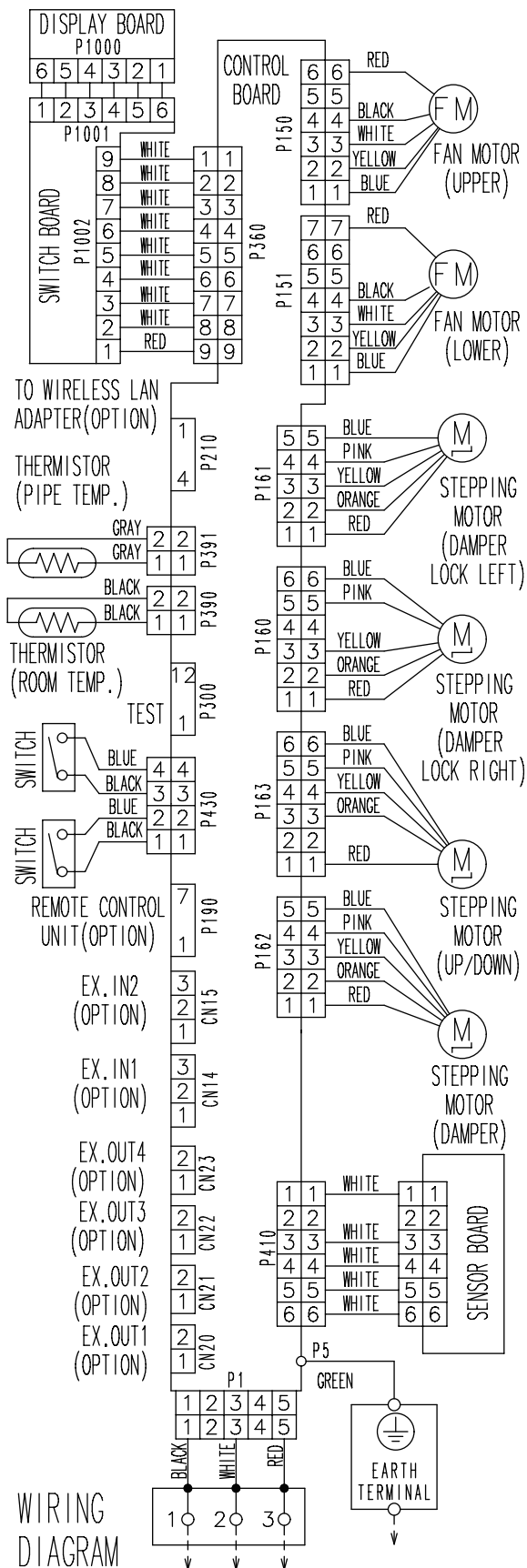

6. Air velocity and temperature distributions

6-1. Compact cassette type

■ Models: AUXG07-09KVLA

- Air velocity distribution

Measuring conditions	Fan speed	Operation mode
	HIGH	FAN

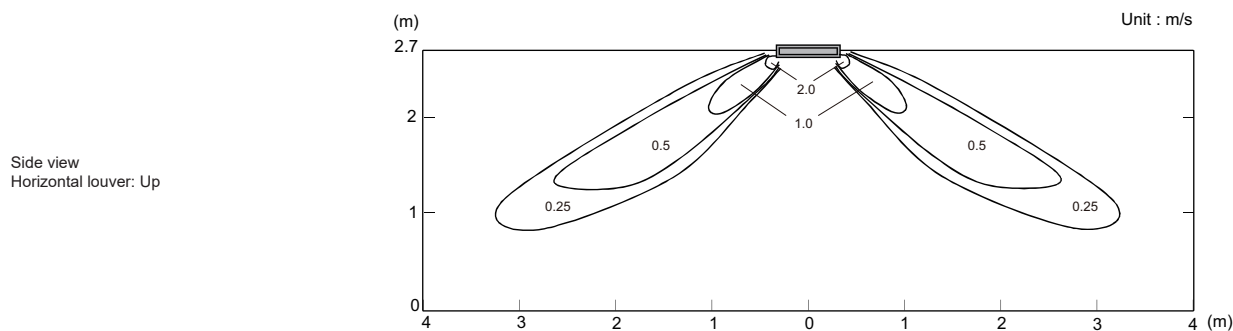
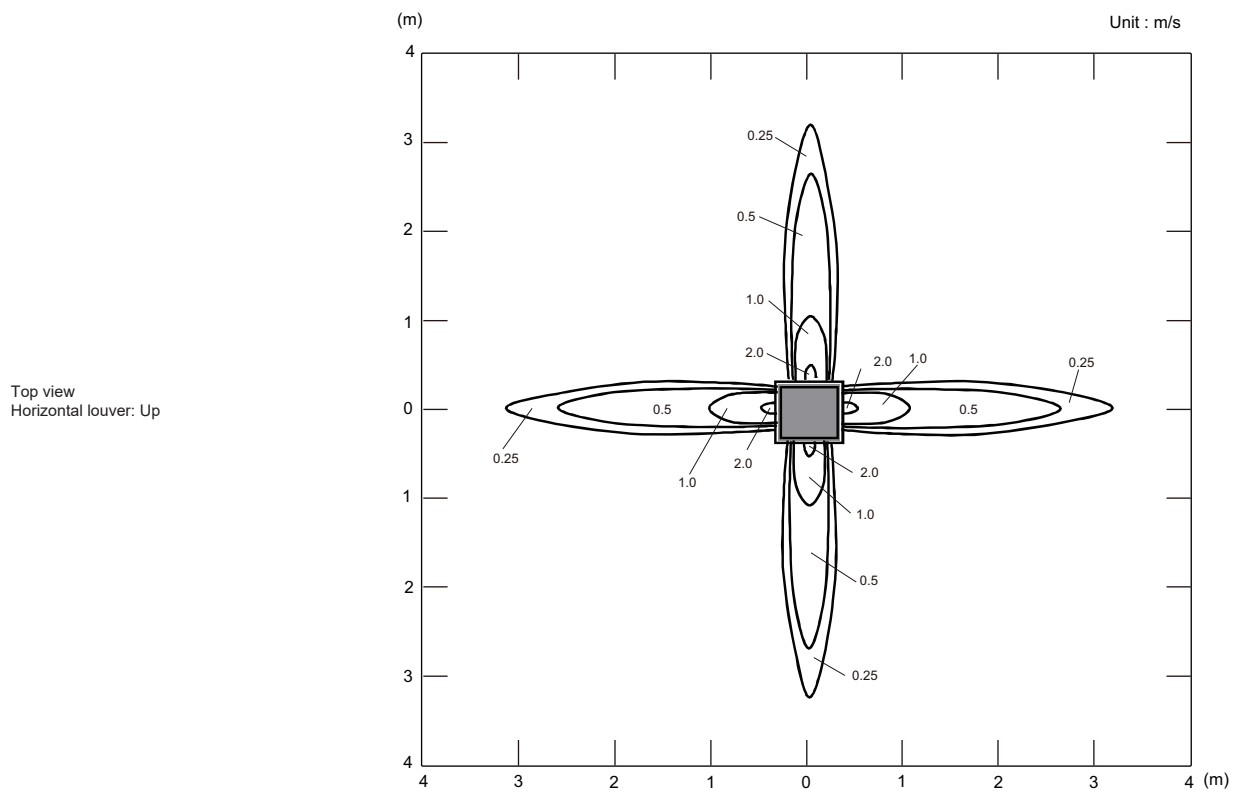

• Air velocity distribution

Measuring conditions	Fan speed	Operation mode	Outlet directions
NOTE: Reference data	HIGH	HEAT	4-way air outlet

Side view
Horizontal louver: Down

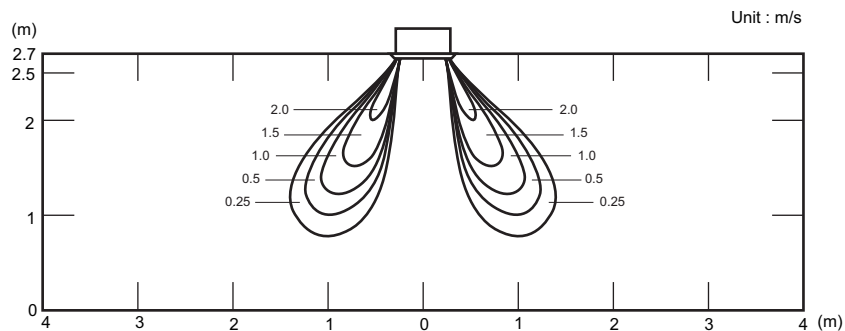

• Air temperature distribution

Measuring conditions	Fan speed	Operation mode	Outlet directions
NOTE: Reference data	HIGH	HEAT	4-way air outlet

Side view
Horizontal louver: Down

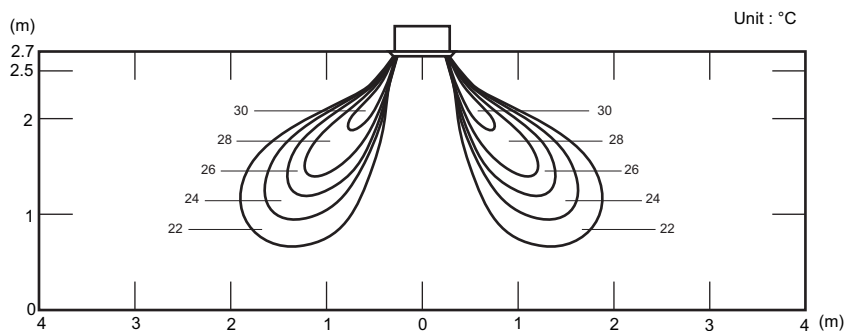

Model: AUXG12KVLA

- Air velocity distribution

Measuring conditions	Fan speed	Operation mode
	HIGH	FAN

Top view
Horizontal louver: Up

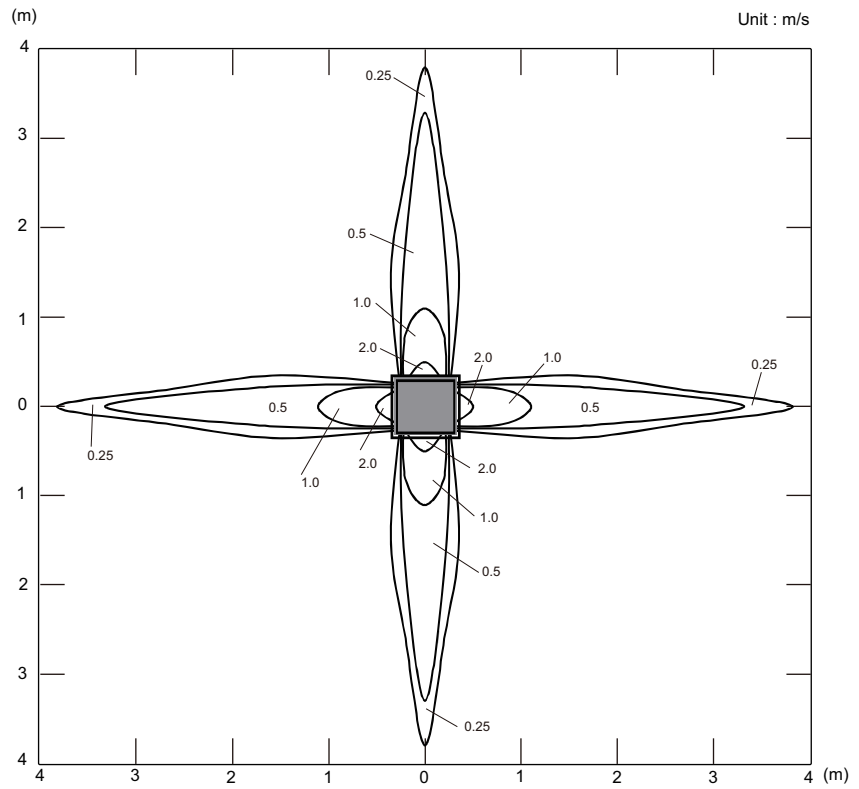

Side view
Horizontal louver: Up

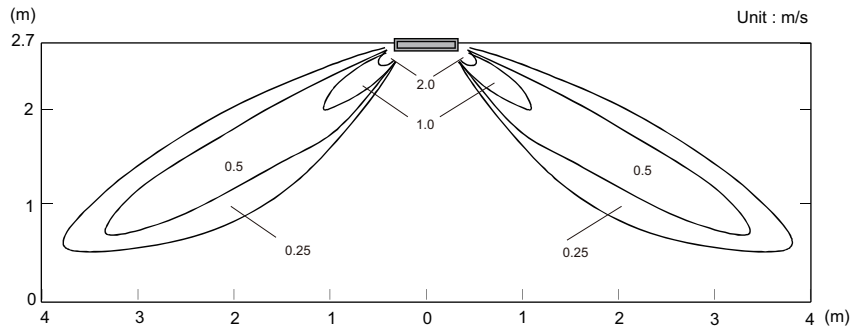

• Air velocity distribution

Measuring conditions	Fan speed	Operation mode	Outlet directions
NOTE: Reference data	HIGH	HEAT	4-way air outlet

Side view
Horizontal louver: Down

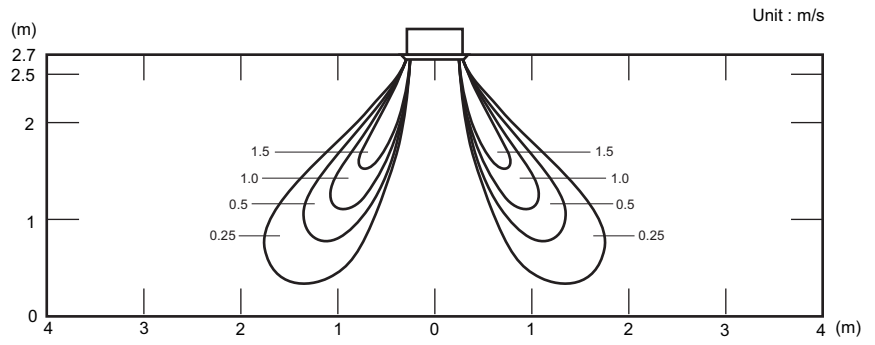

• Air temperature distribution

Measuring conditions	Fan speed	Operation mode	Outlet directions
NOTE: Reference data	HIGH	HEAT	4-way air outlet

Side view
Horizontal louver: Down

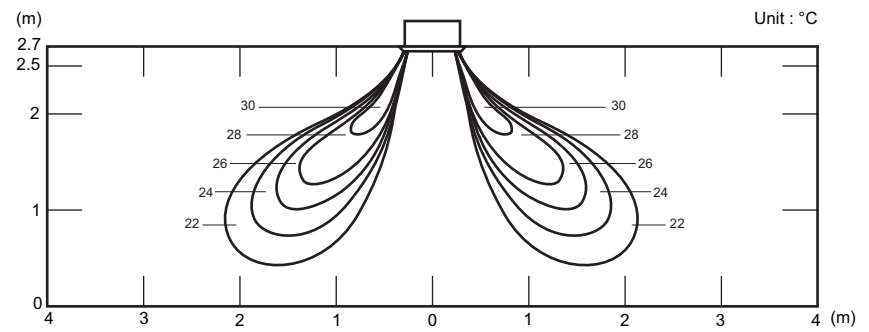

Model: AUXG14KVL A

- Air velocity distribution

Measuring conditions	Fan speed	Operation mode
	HIGH	FAN

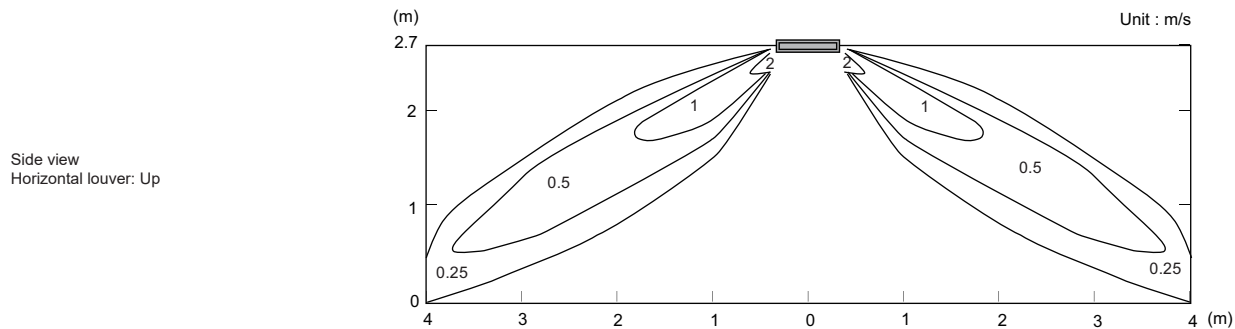
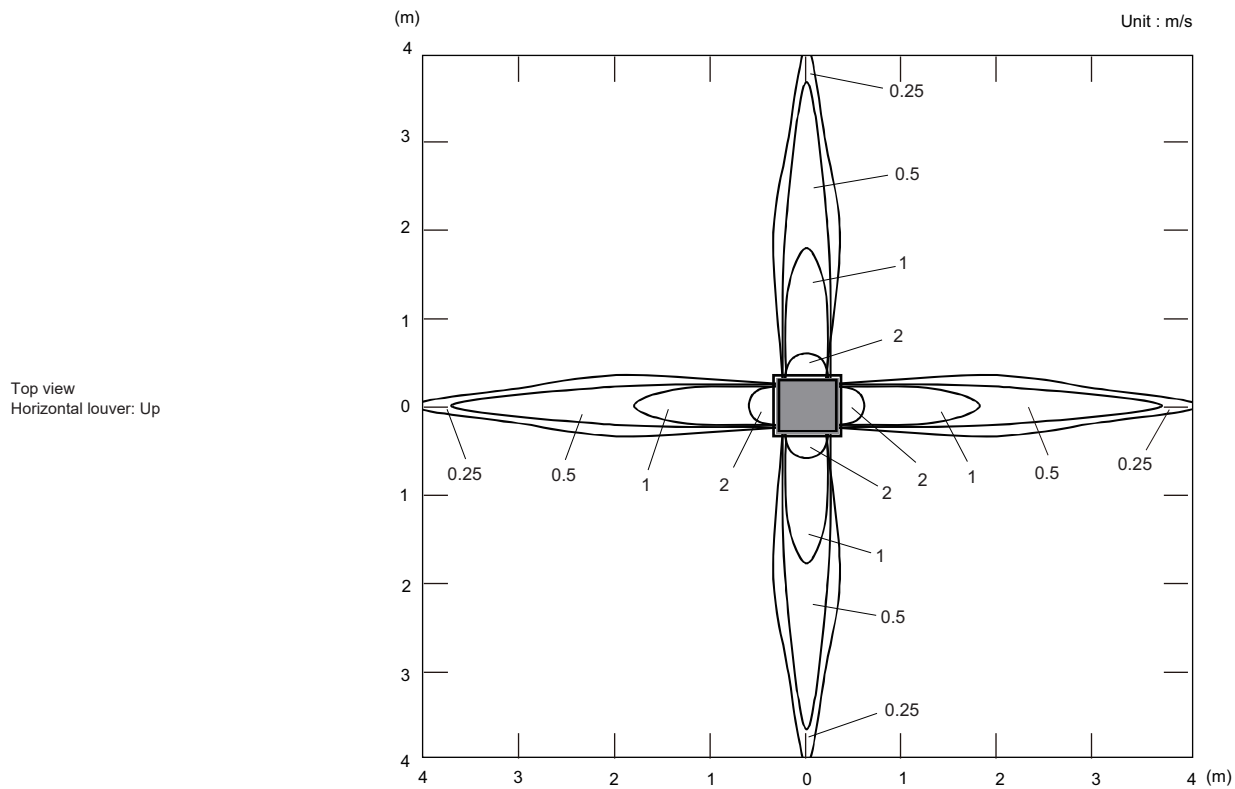

• Air velocity distribution

Measuring conditions	Fan speed	Operation mode	Outlet directions
NOTE: Reference data	HIGH	HEAT	4-way air outlet

Side view
Horizontal louver: Down

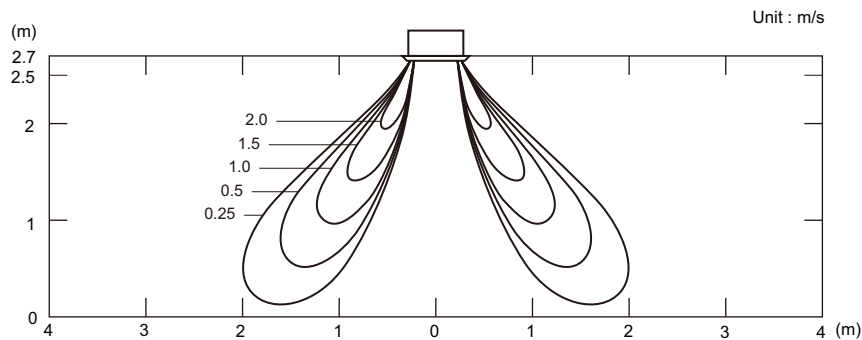

• Air temperature distribution

Measuring conditions	Fan speed	Operation mode	Outlet directions
NOTE: Reference data	HIGH	HEAT	4-way air outlet

Side view
Horizontal louver: Down

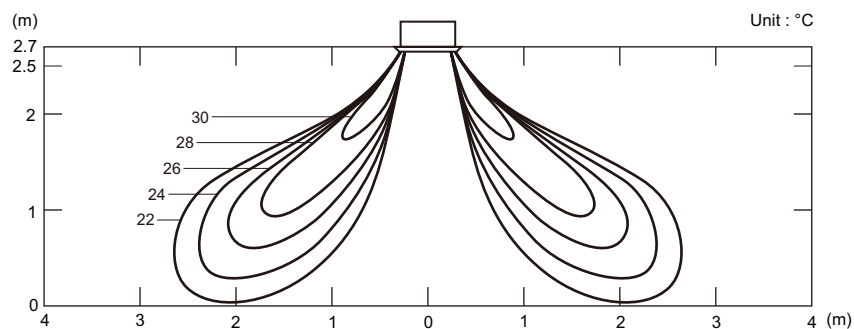

6-2. Mini duct type

Model: ARXG07KSLAP

NOTE: This data is measured after installing optional Auto louver grille kit.

- Air velocity distribution

Measuring conditions	Fan speed	Operation mode
	HIGH	FAN

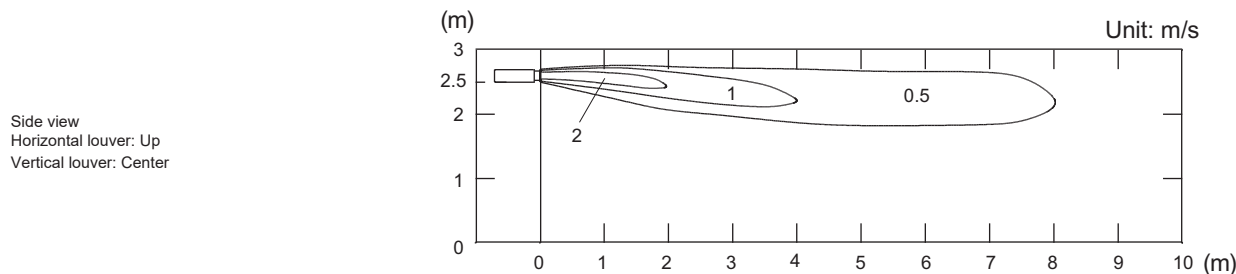
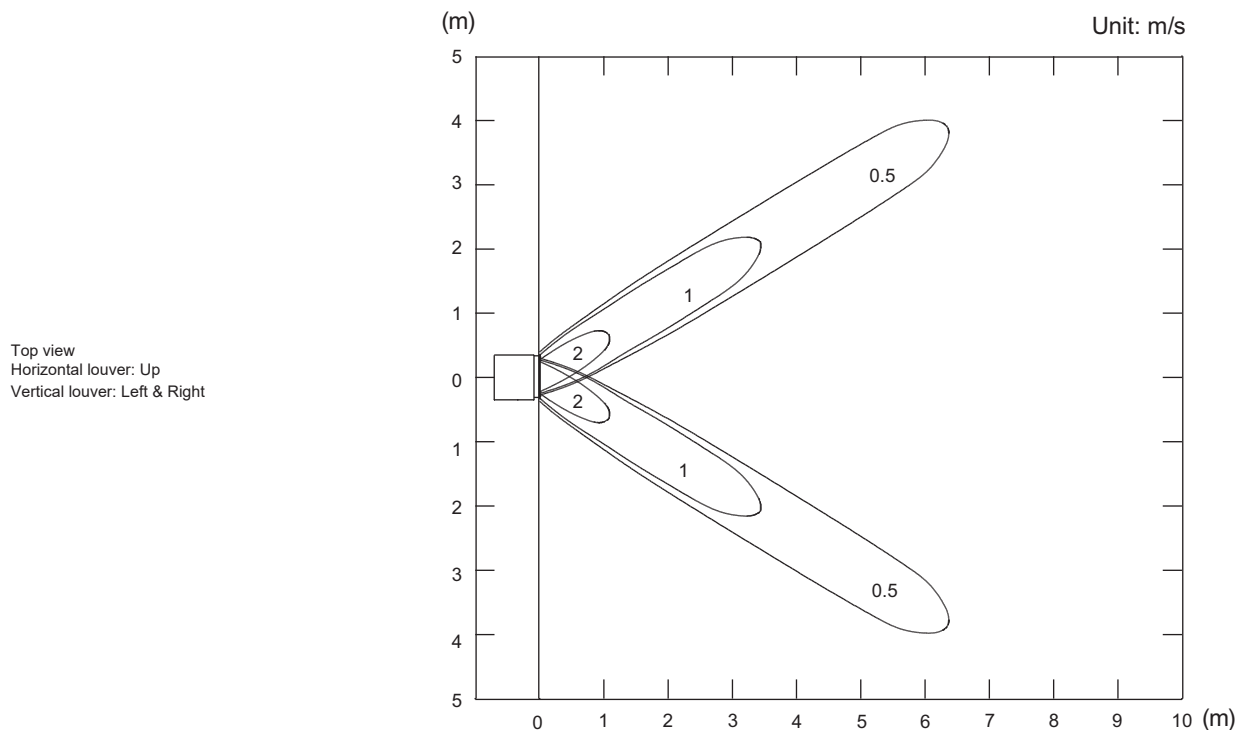
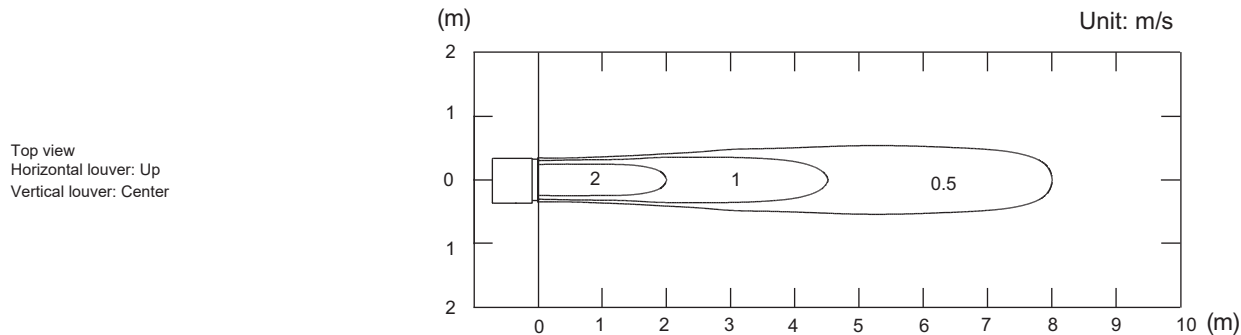

• Air velocity distribution

Measuring conditions	Fan speed	Operation mode
	HIGH	HEAT

Side view
Horizontal louver: Down
Vertical louver: Center

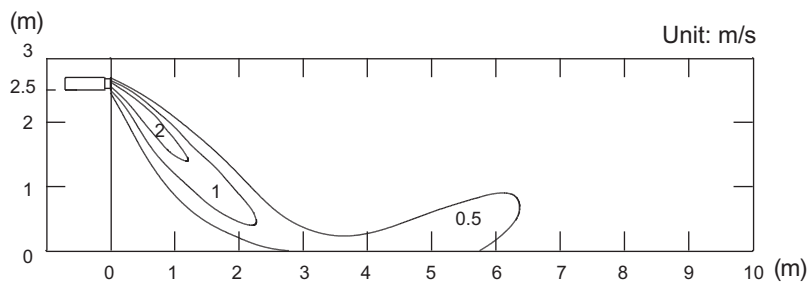

• Air temperature distribution

Measuring conditions	Fan speed	Operation mode
	HIGH	HEAT

Side view
Horizontal louver: Down
Vertical louver: Center

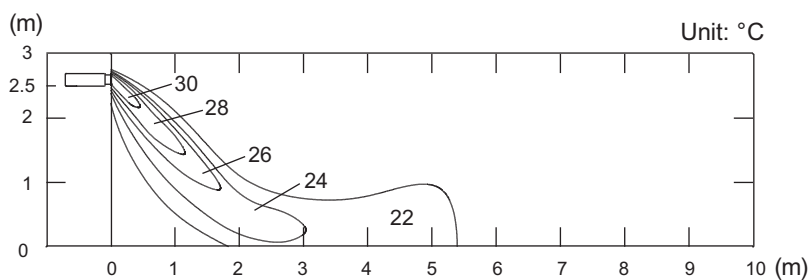

Model: ARXG09KSLAP

NOTE: This data is measured after installing optional Auto Louver Grille Kit.

- Air velocity distribution

Measuring conditions	Fan speed	Operation mode
	HIGH	FAN

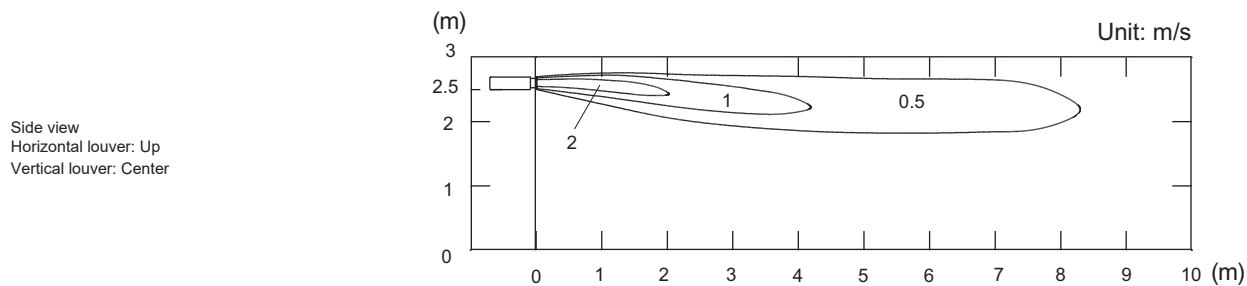
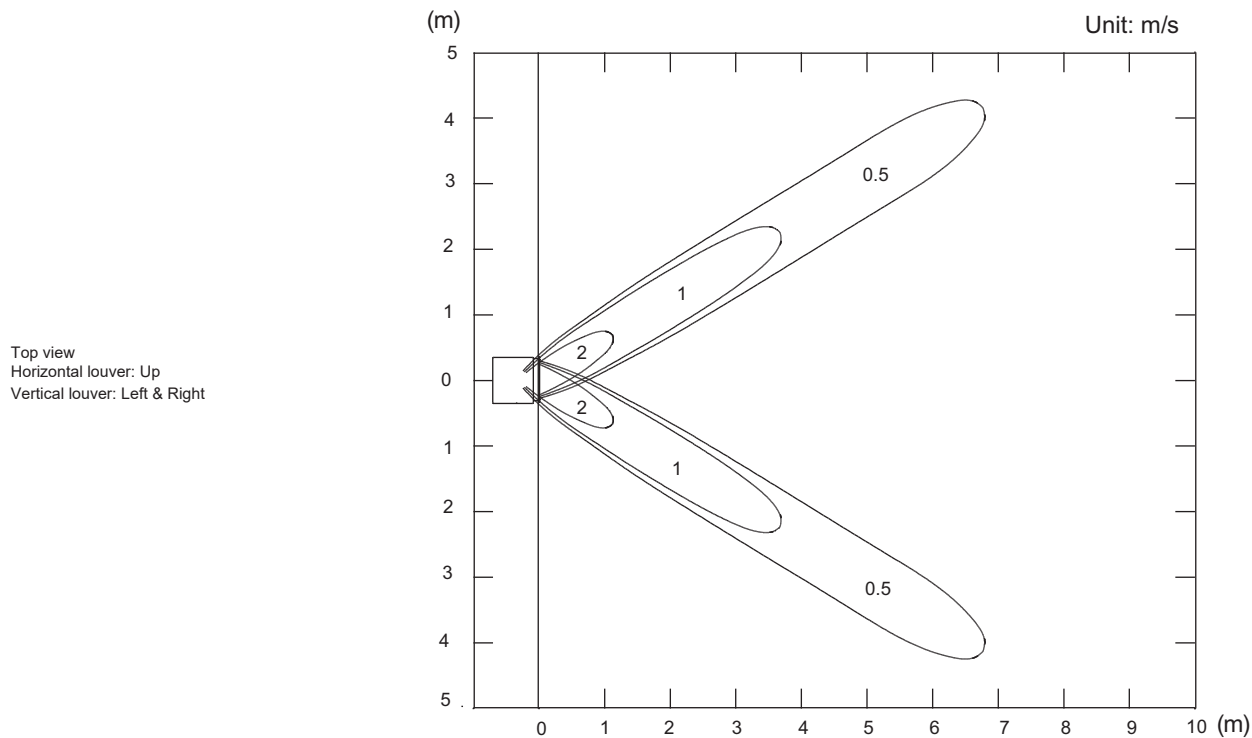
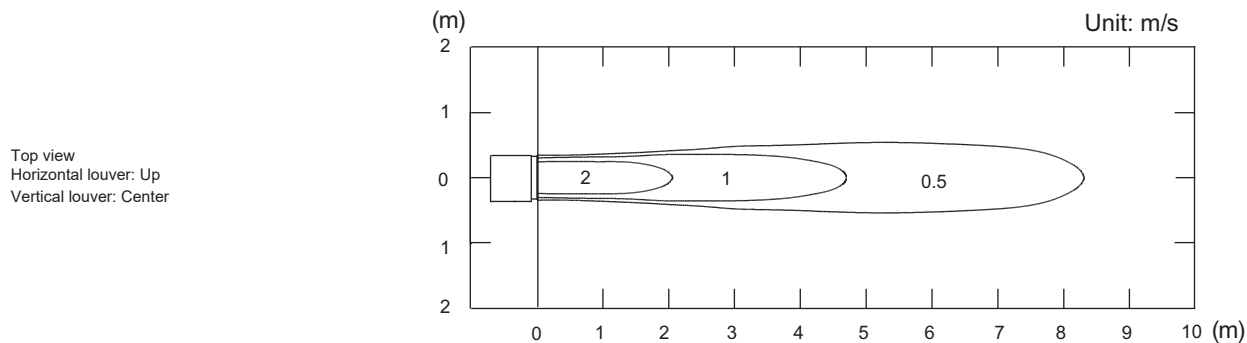

• Air velocity distribution

Measuring conditions	Fan speed	Operation mode
	HIGH	HEAT

Side view
Horizontal louver: Down
Vertical louver: Center

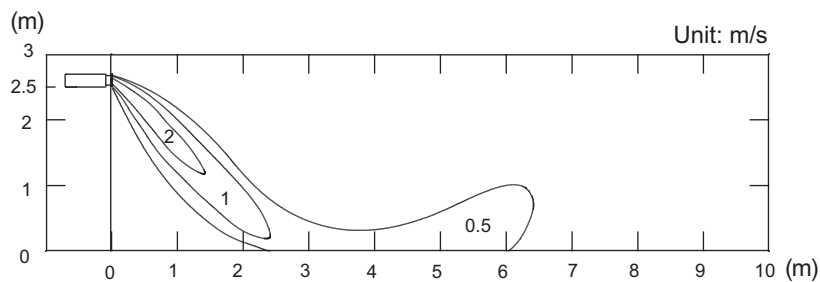

• Air temperature distribution

Measuring conditions	Fan speed	Operation mode
	HIGH	HEAT

Side view
Horizontal louver: Down
Vertical louver: Center

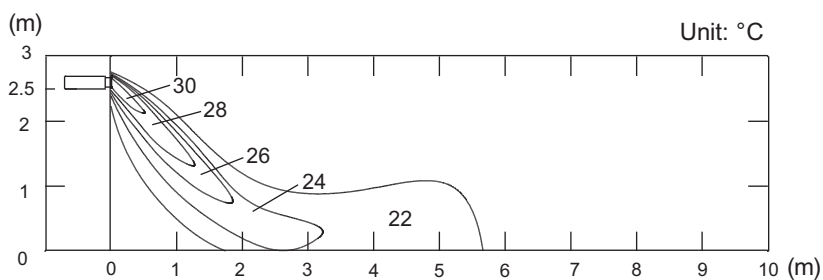

Model: ARXG12KSLAP

NOTE: This data is measured after installing optional Auto Louver Grille Kit.

- Air velocity distribution

Measuring conditions	Fan speed	Operation mode
	HIGH	FAN

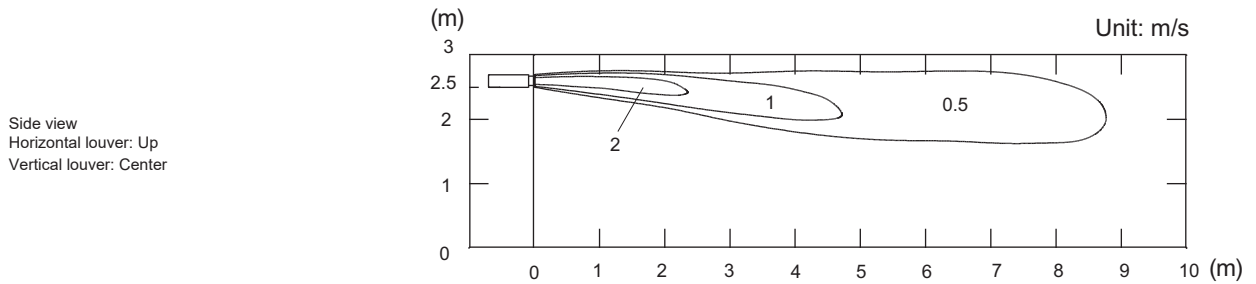
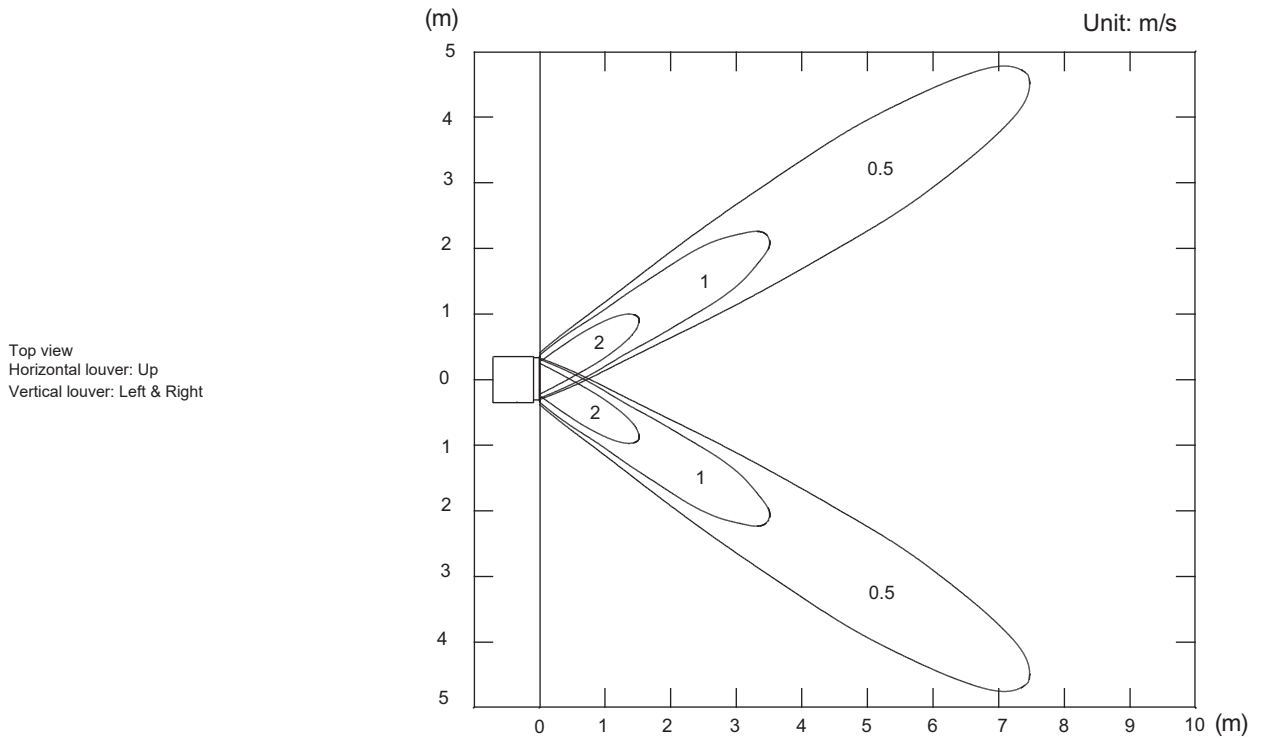
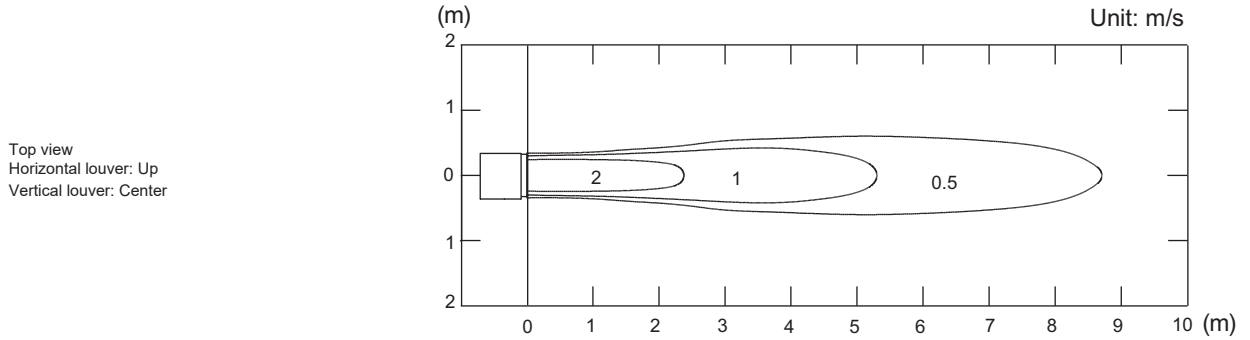

• Air velocity distribution

Measuring conditions	Fan speed	Operation mode
	HIGH	HEAT

Side view
Horizontal louver: Down
Vertical louver: Center

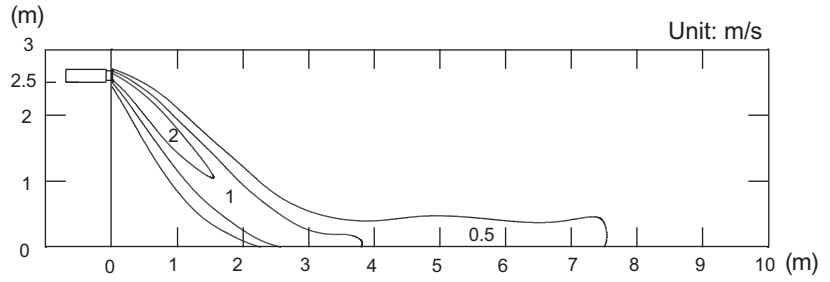

• Air temperature distribution

Measuring conditions	Fan speed	Operation mode
	HIGH	HEAT

Side view
Horizontal louver: Down
Vertical louver: Center

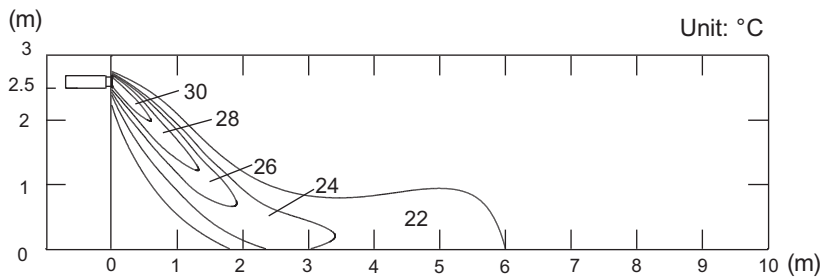

Model: ARXG14KSLAP

NOTE: This data is measured after installing optional Auto louver grille kit.

- Air velocity distribution

Measuring conditions	Fan speed	Operation mode
	HIGH	FAN

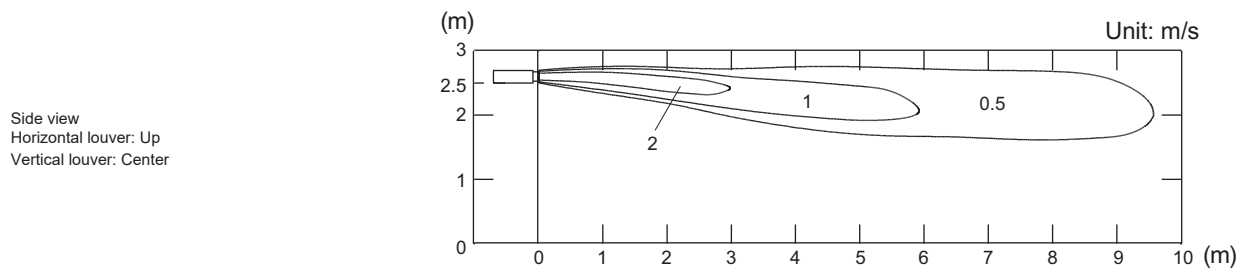
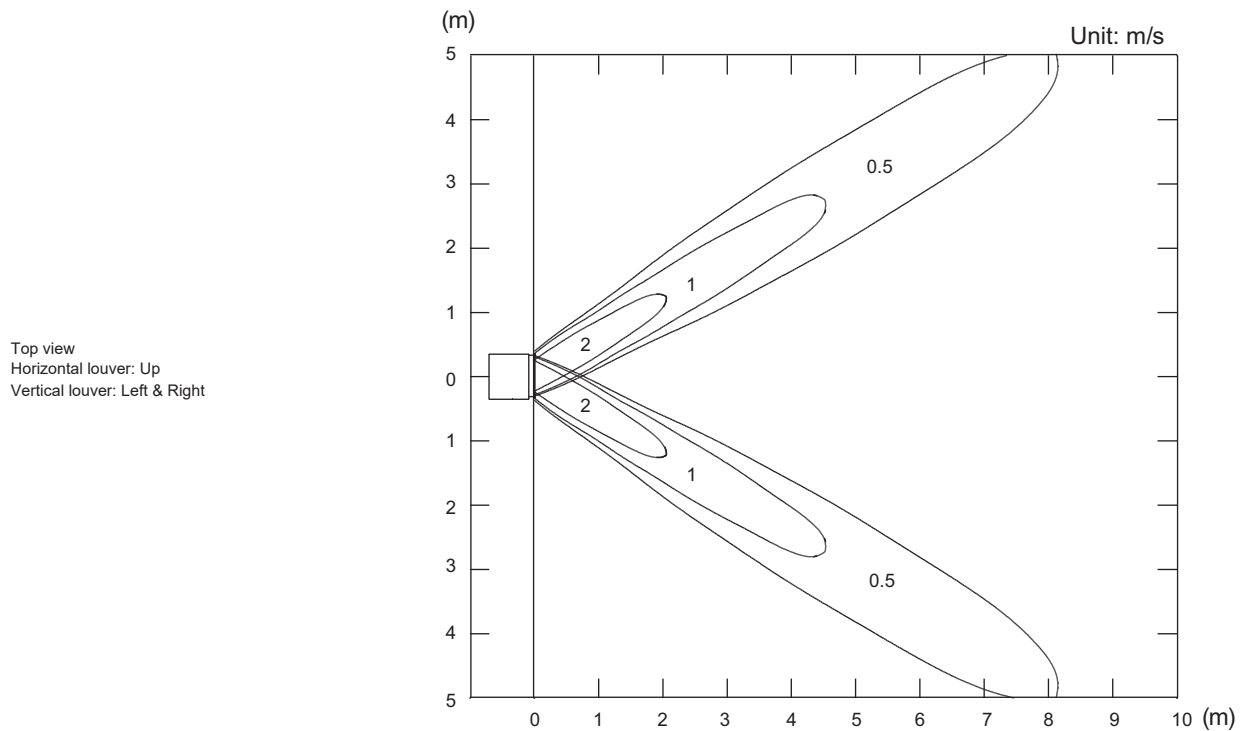
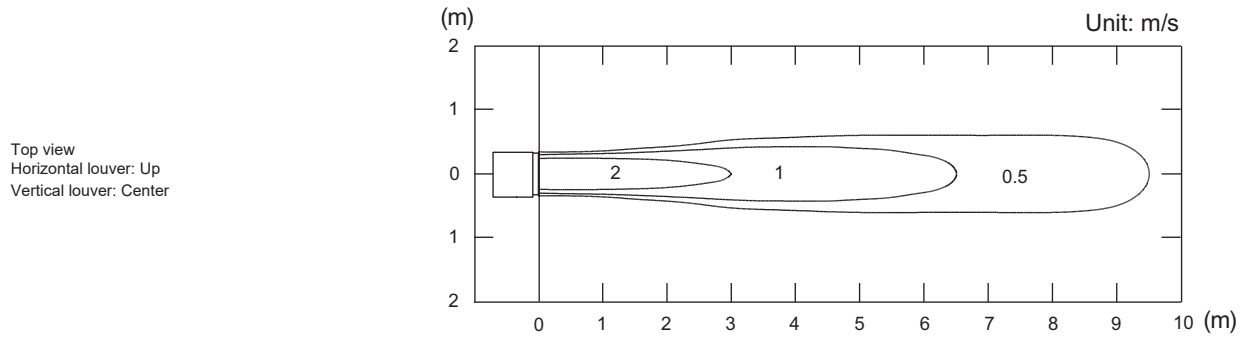

• Air velocity distribution

Measuring conditions	Fan speed	Operation mode
	HIGH	HEAT

Side view
Horizontal louver: Down
Vertical louver: Center

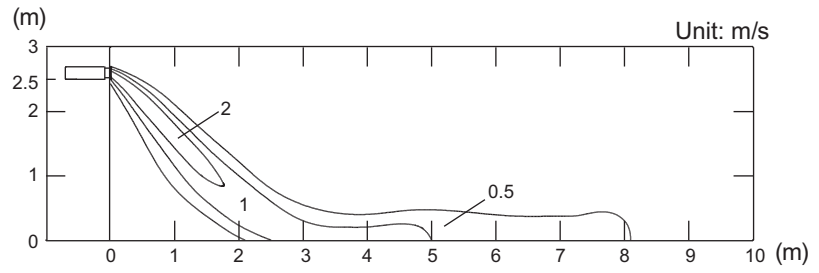

• Air temperature distribution

Measuring conditions	Fan speed	Operation mode
	HIGH	HEAT

Side view
Horizontal louver: Down
Vertical louver: Center

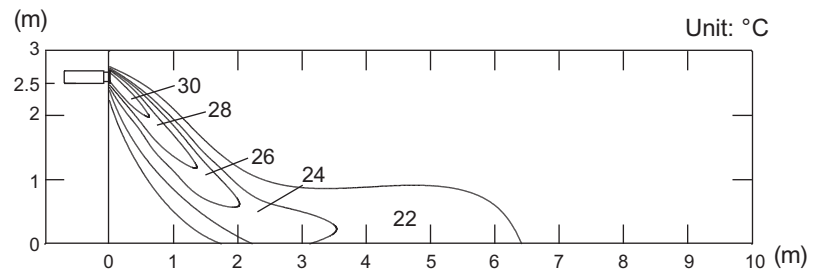

6-3. Slim duct type

Model: ARXG07KLLAP

NOTE: This data is measured after installing optional Auto louver grille kit.

- Air velocity distribution

Measuring conditions	Fan speed	Operation mode
	HIGH	FAN

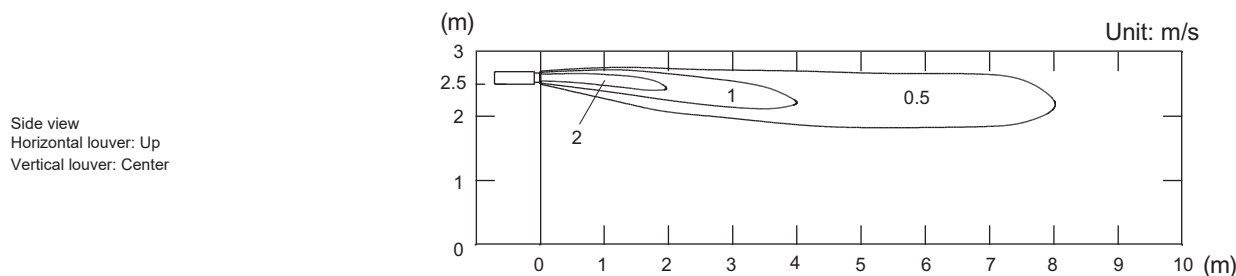
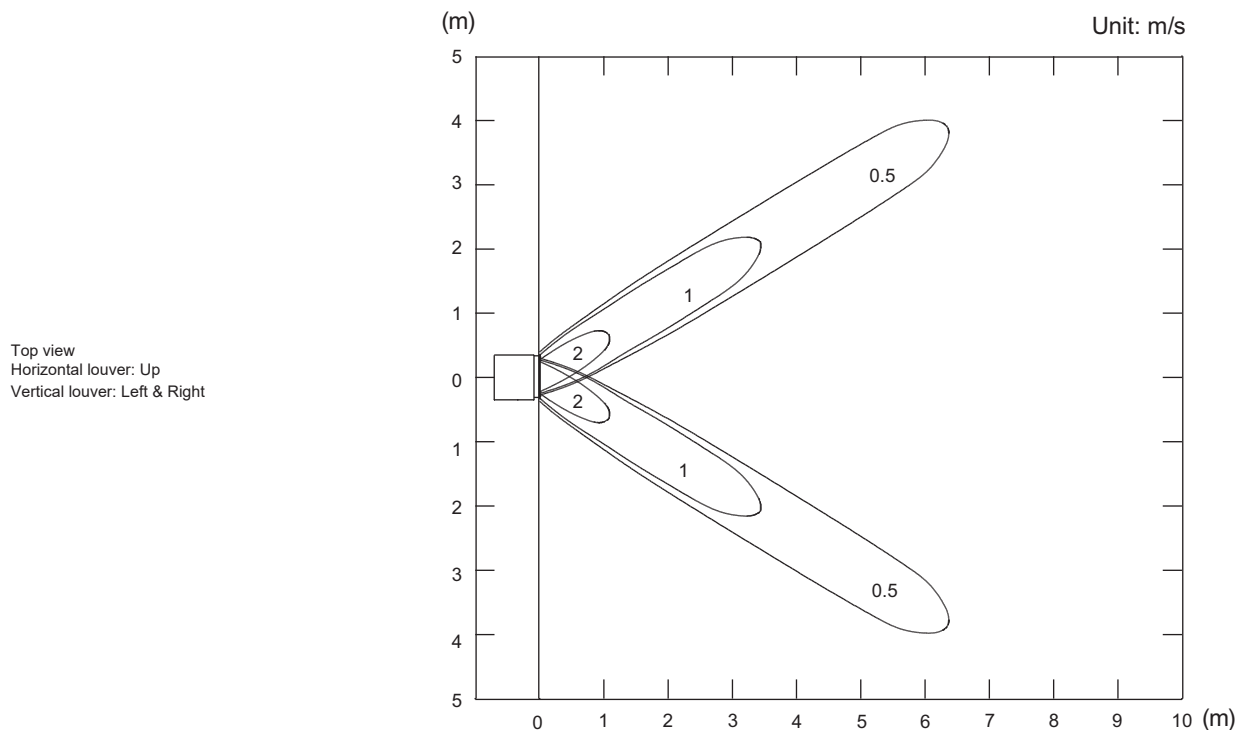
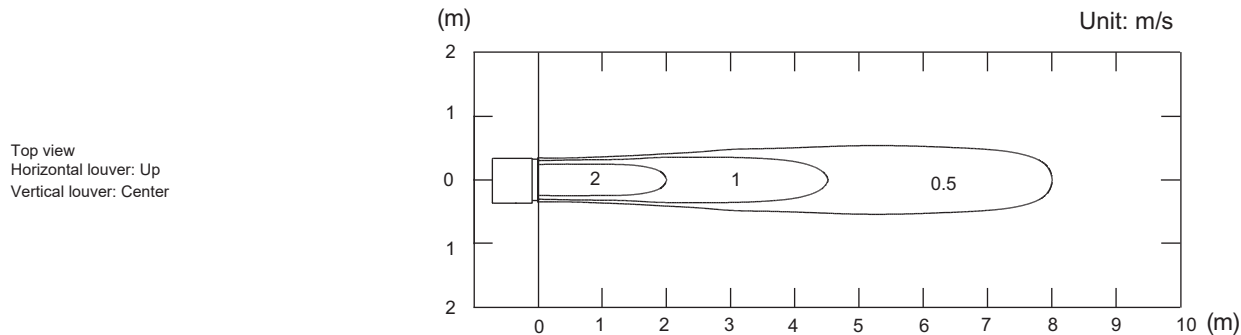

• Air velocity distribution

Measuring conditions	Fan speed	Operation mode
	HIGH	HEAT

Side view
Horizontal louver: Down
Vertical louver: Center

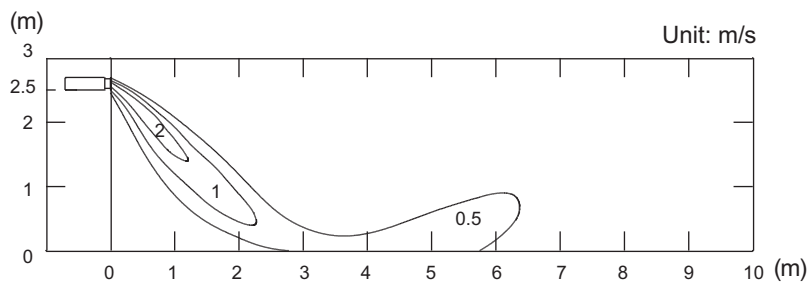

• Air temperature distribution

Measuring conditions	Fan speed	Operation mode
	HIGH	HEAT

Side view
Horizontal louver: Down
Vertical louver: Center

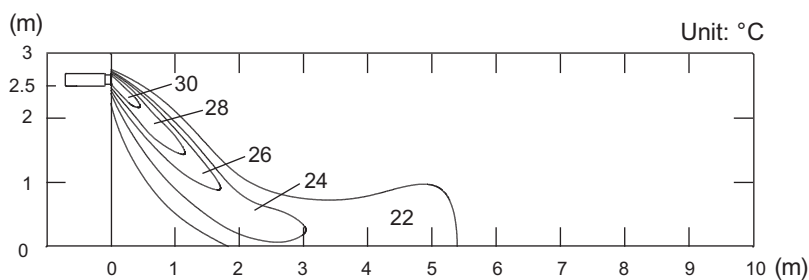

Model: ARXG09KLLAP

NOTE: This data is measured after installing optional Auto louver grille kit.

- Air velocity distribution

Measuring conditions	Fan speed	Operation mode
	HIGH	FAN

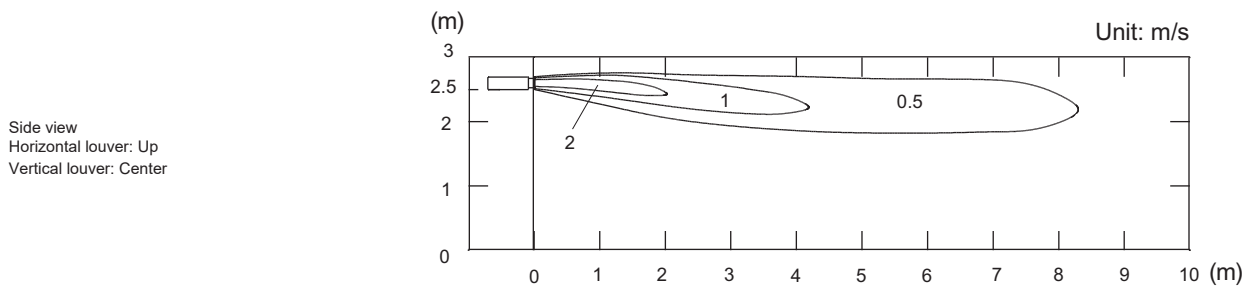
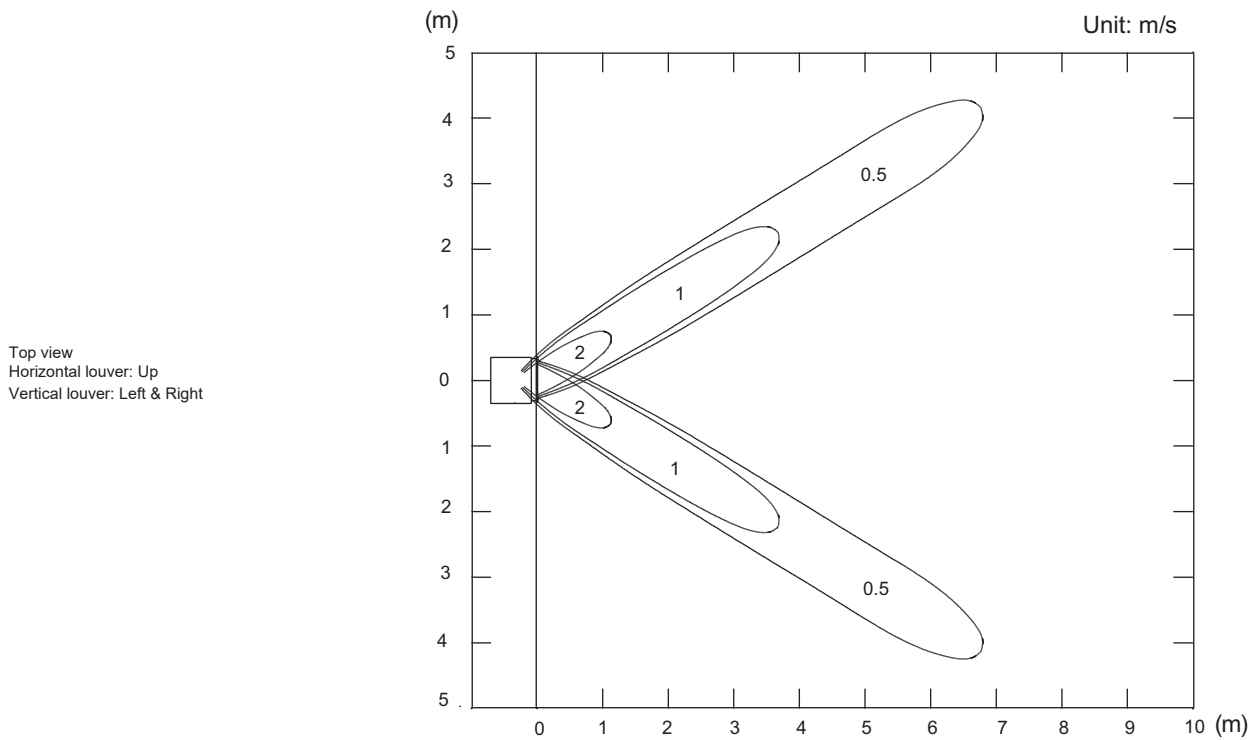
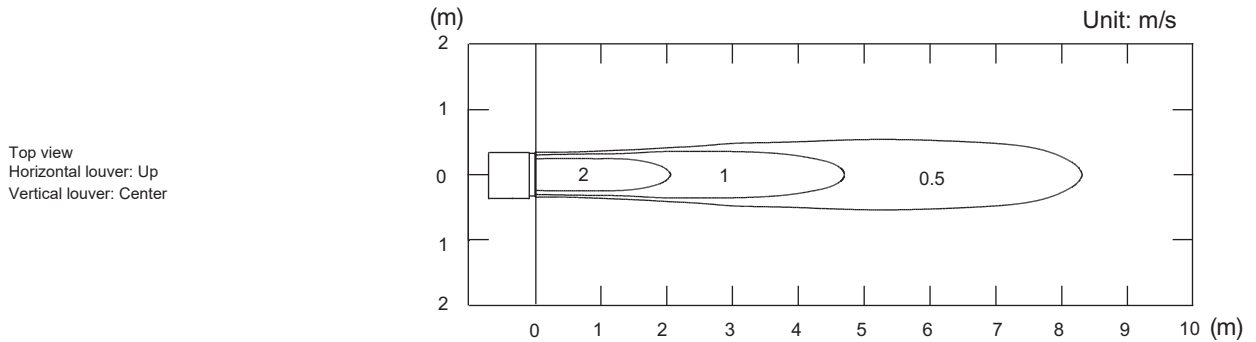

• Air velocity distribution

Measuring conditions	Fan speed	Operation mode
	HIGH	HEAT

Side view
Horizontal louver: Down
Vertical louver: Center

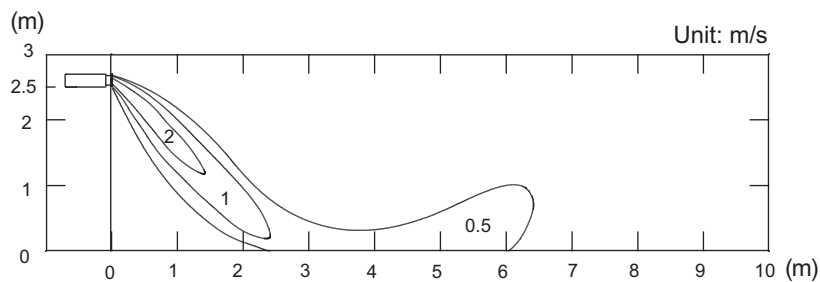

• Air temperature distribution

Measuring conditions	Fan speed	Operation mode
	HIGH	HEAT

Side view
Horizontal louver: Down
Vertical louver: Center

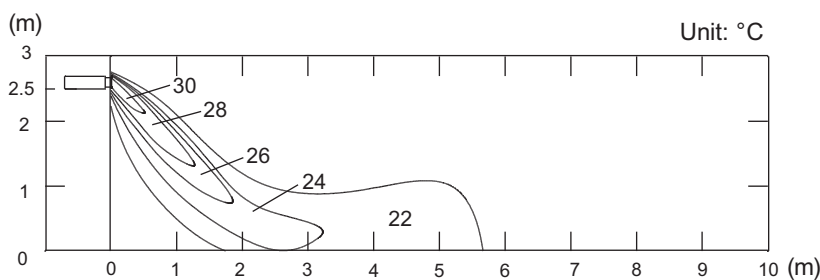

Model: ARXG12KLLAP

NOTE: This data is measured after installing optional Auto louver grille kit.

- Air velocity distribution

Measuring conditions	Fan speed	Operation mode
	HIGH	FAN

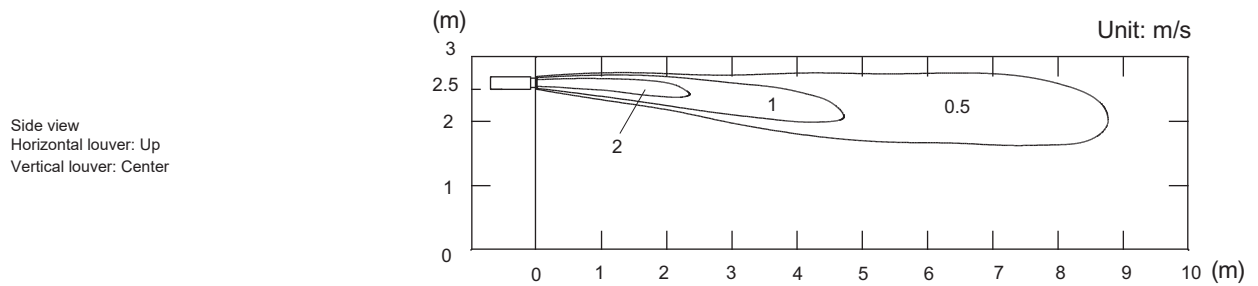
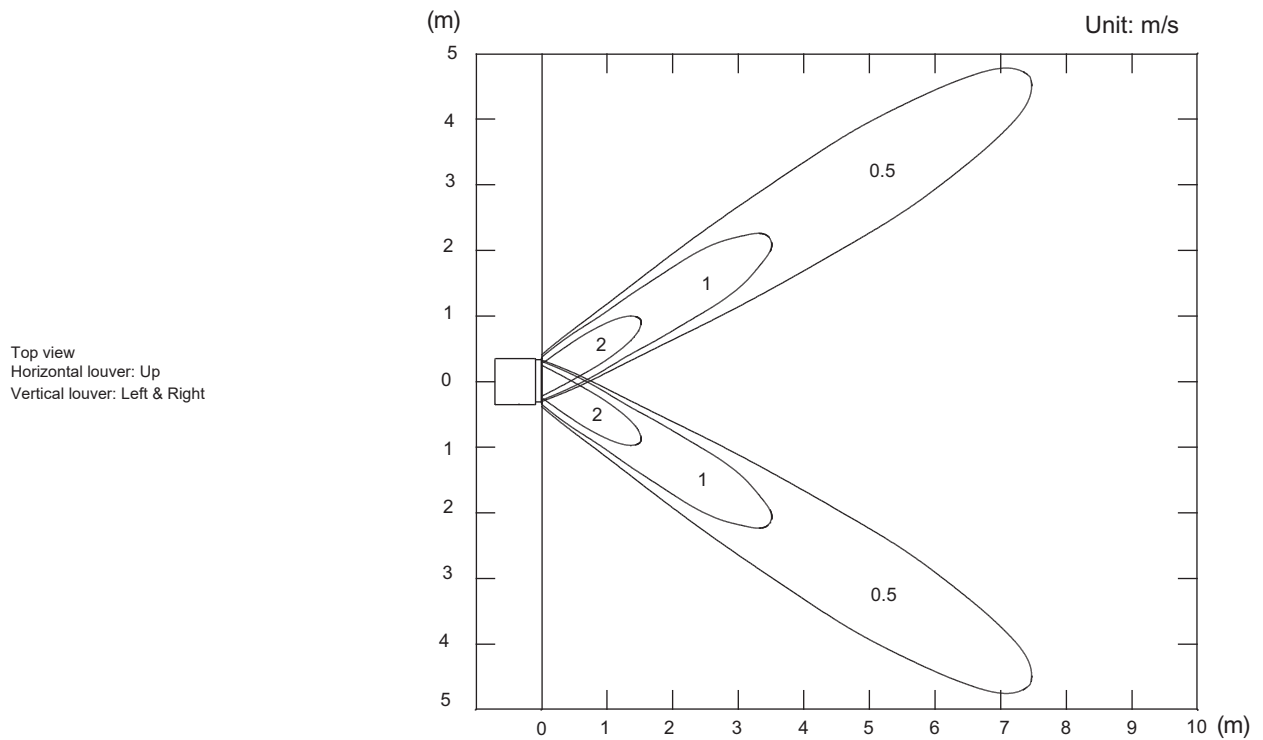
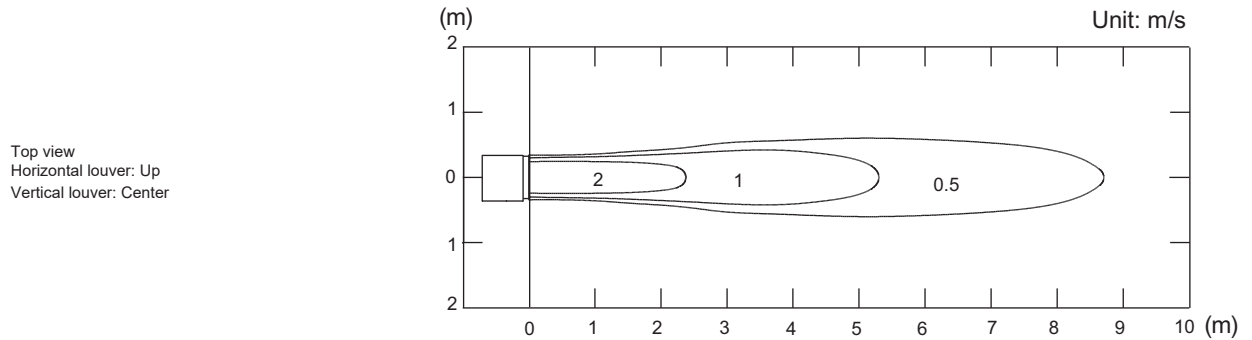

• Air velocity distribution

Measuring conditions	Fan speed	Operation mode
	HIGH	HEAT

Side view
Horizontal louver: Down
Vertical louver: Center

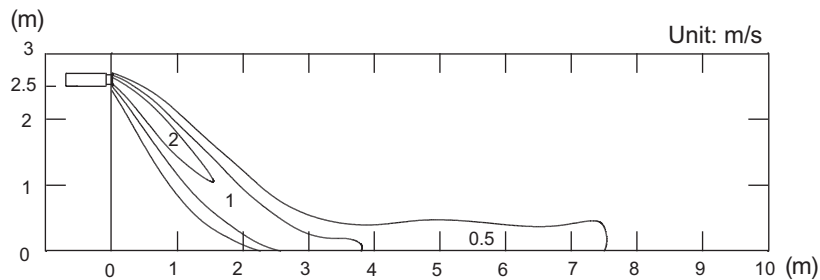

• Air temperature distribution

Measuring conditions	Fan speed	Operation mode
	HIGH	HEAT

Side view
Horizontal louver: Down
Vertical louver: Center

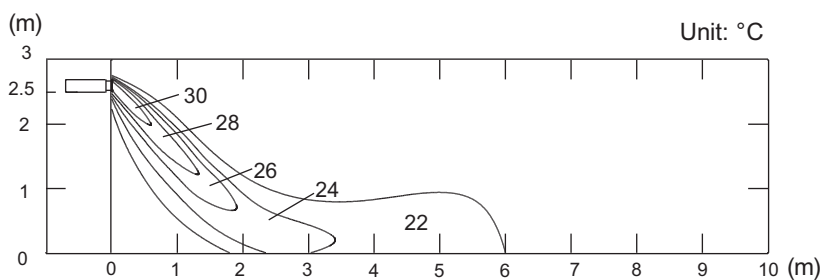

Model: ARXG14KLLAP

NOTE: This data is measured after installing optional Auto louver grille kit.

- Air velocity distribution

Measuring conditions	Fan speed	Operation mode
	HIGH	FAN

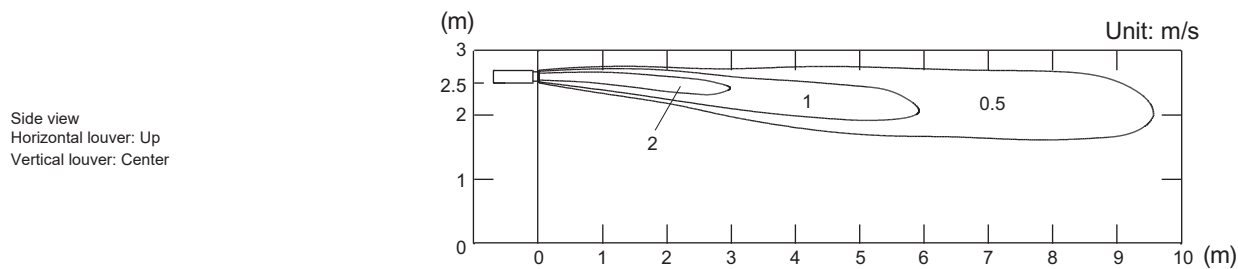
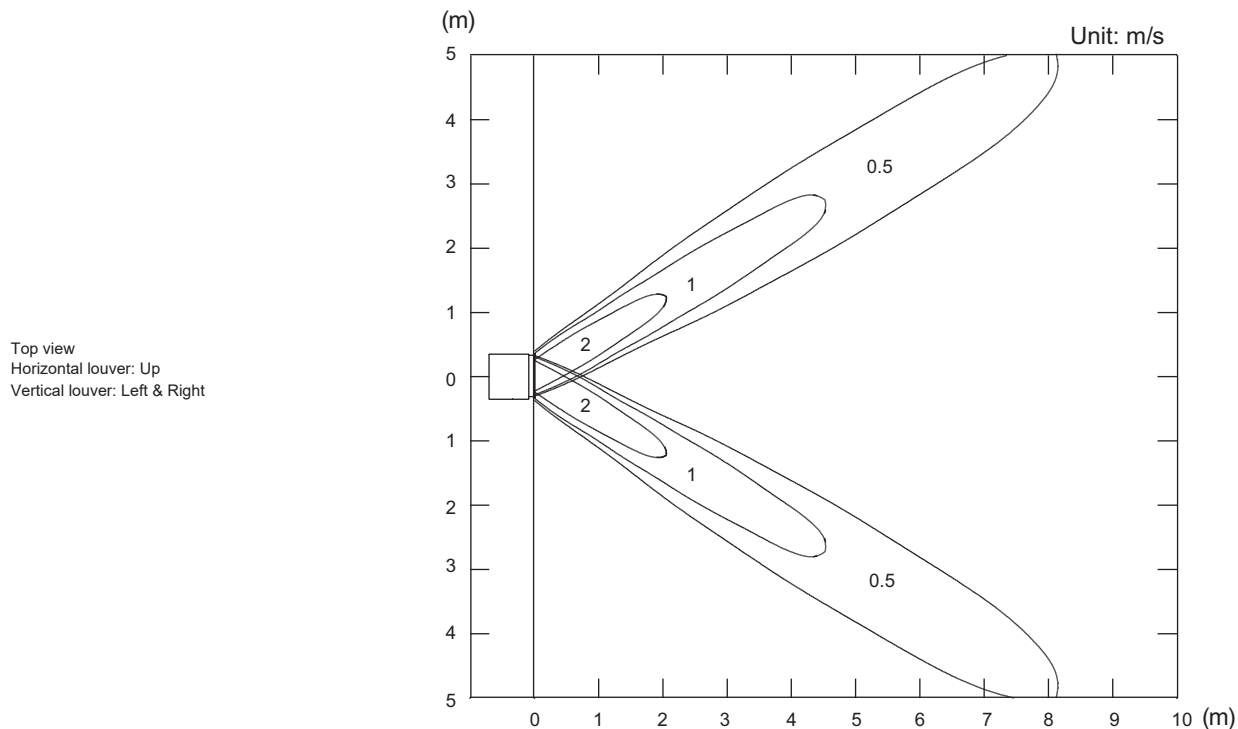
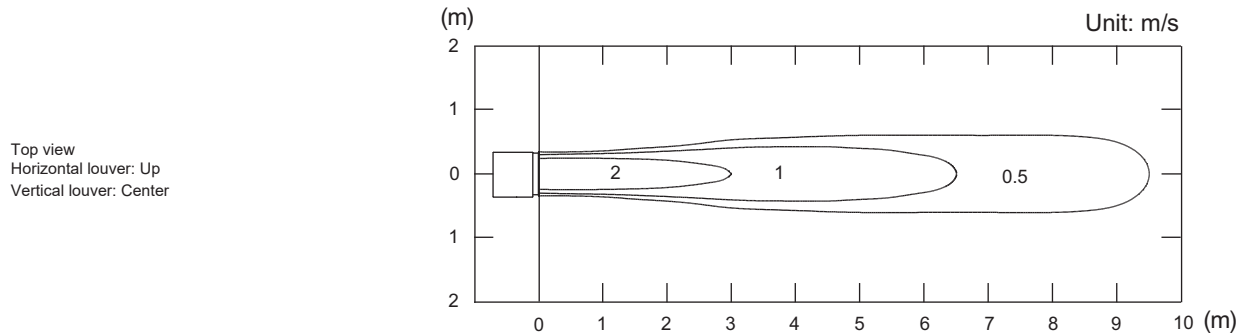

• Air velocity distribution

Measuring conditions	Fan speed	Operation mode
	HIGH	HEAT

Side view
Horizontal louver: Down
Vertical louver: Center

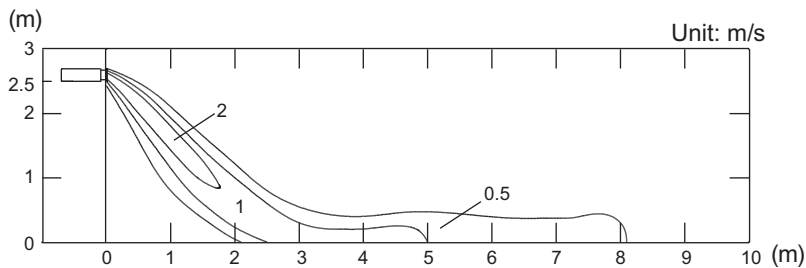

• Air temperature distribution

Measuring conditions	Fan speed	Operation mode
	HIGH	HEAT

Side view
Horizontal louver: Down
Vertical louver: Center

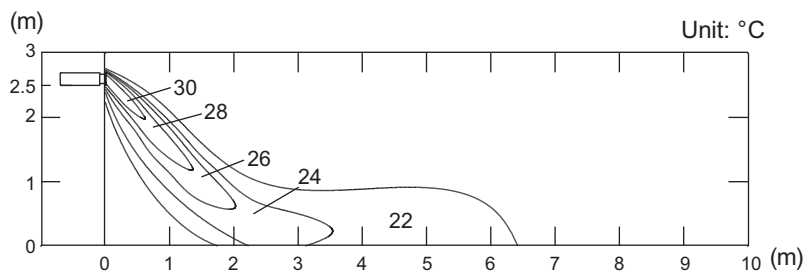

6-4. Wall mounted type

■ Models: ASEH07-12KMCG, ASEH07-12KMCG-B, ASEG07-12KETF, ASEG07-12KETF-B, and ASEH07-09KGTG

Measuring conditions	Fan speed	Operation mode
	HIGH	FAN

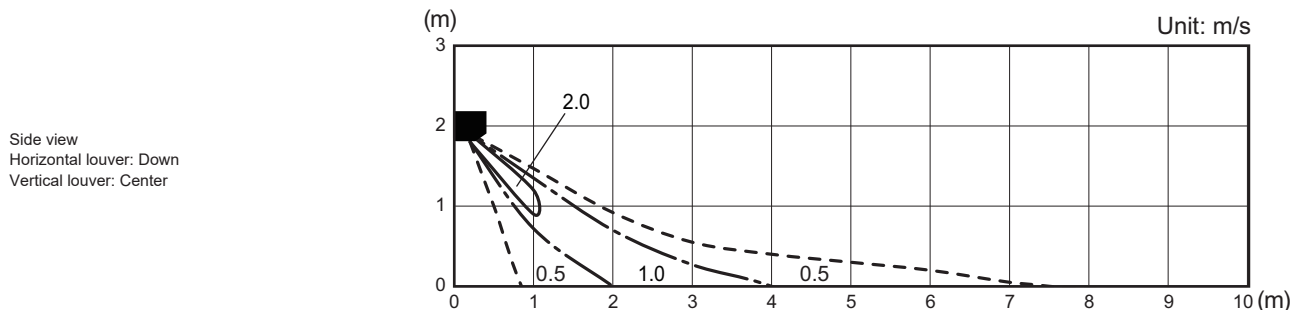
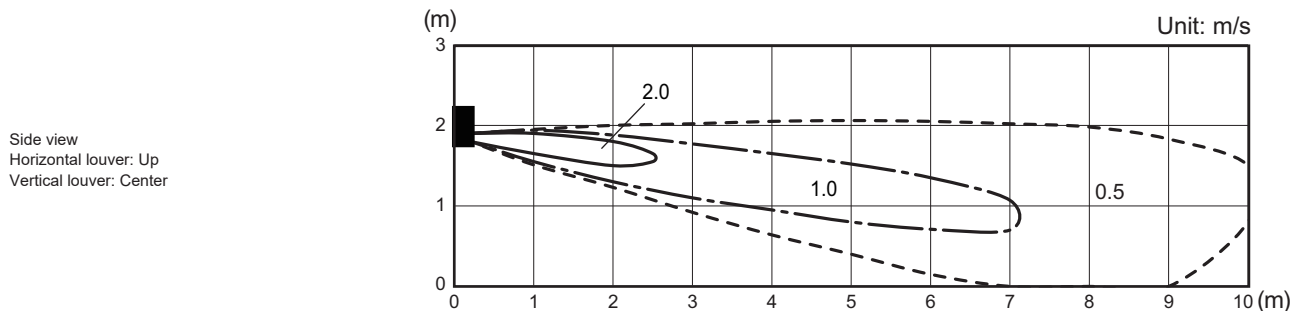
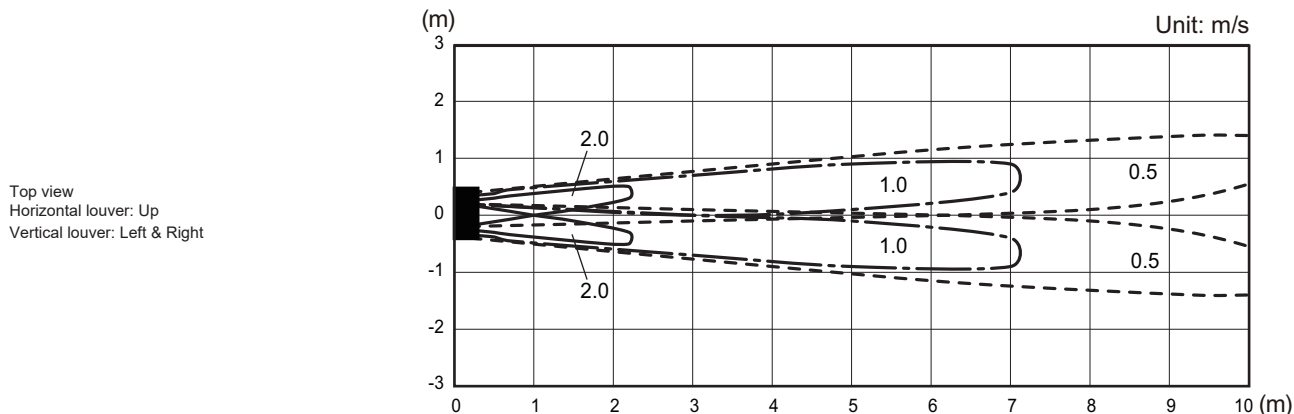
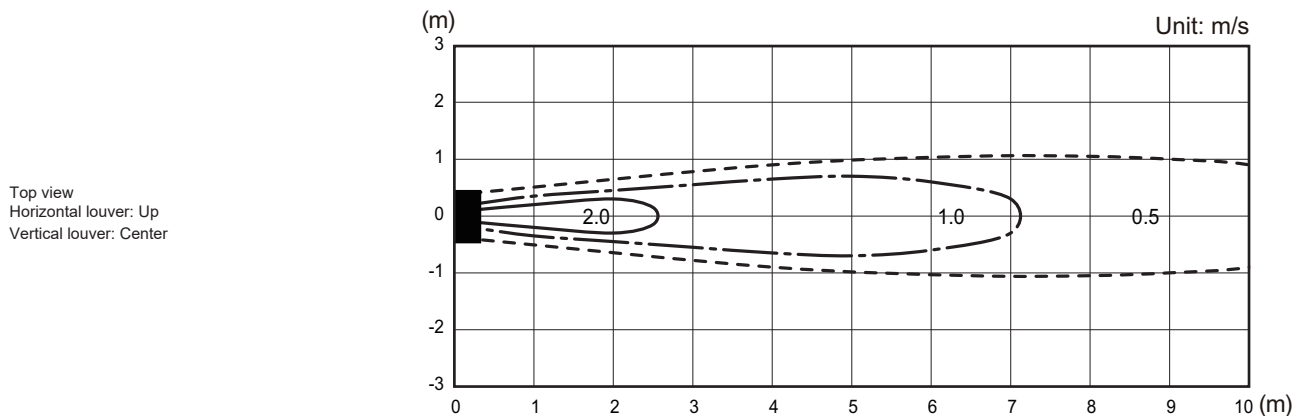

■ Models: ASEH14KMCG, ASEH14KMCG-B, ASEG14KETF, ASEG14KETF-B, and ASEH12-14KGTG

2-UNIT
MULTI-SPLIT TYPE

2-UNIT
MULTI-SPLIT TYPE

Measuring conditions	Fan speed	Operation mode
	HIGH	FAN

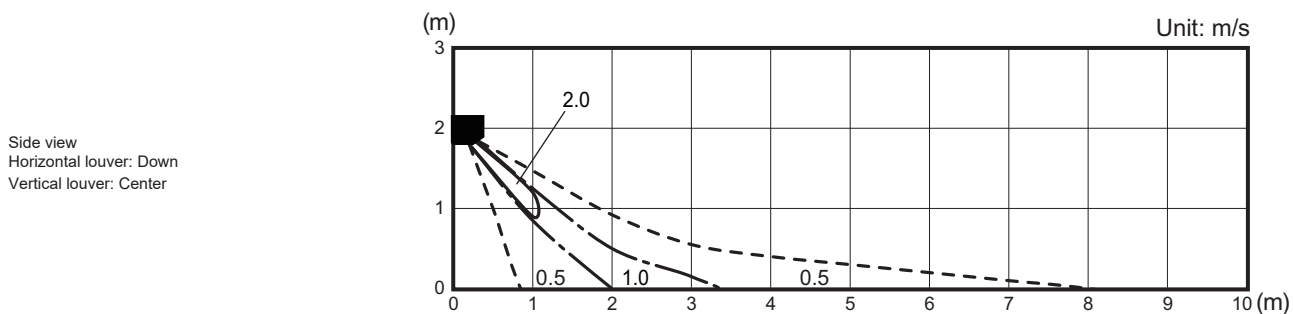
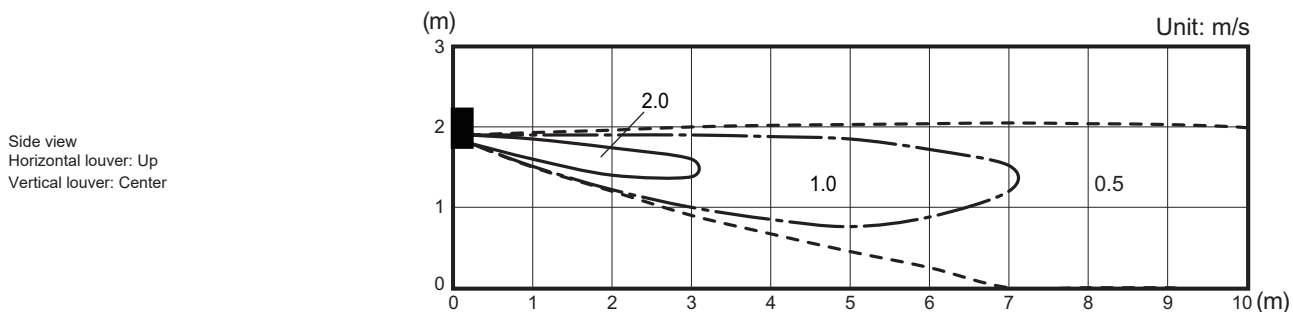
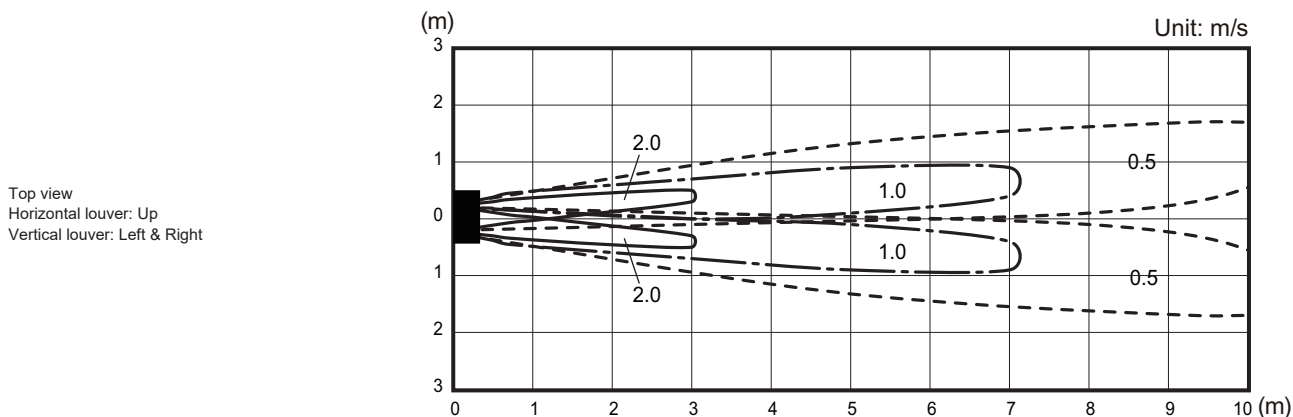
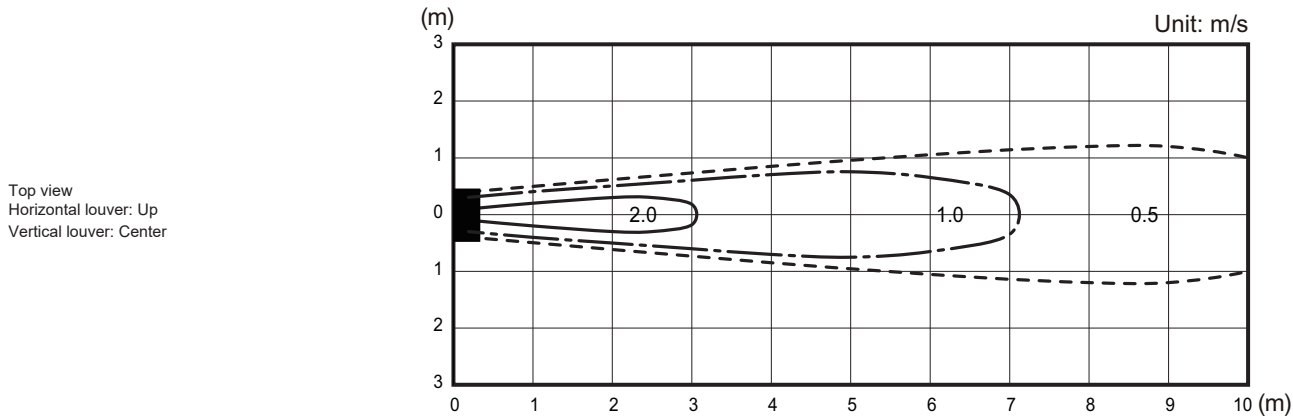

■ Model: ASEH05KNCA

Measuring conditions	Fan speed	Operation mode
	HIGH	FAN

2-UNIT
MULTI-SPLIT TYPE

2-UNIT
MULTI-SPLIT TYPE

Top view
Horizontal louver: Up
Vertical louver: Center

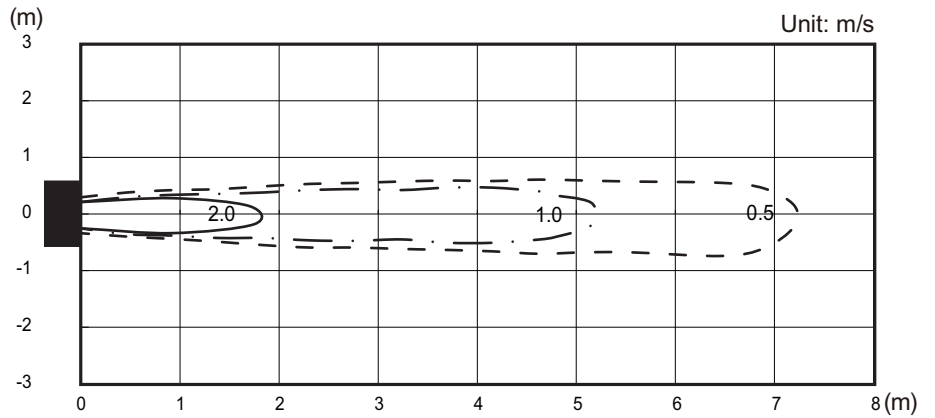

Top view
Horizontal louver: Up
Vertical louver: Left & Right

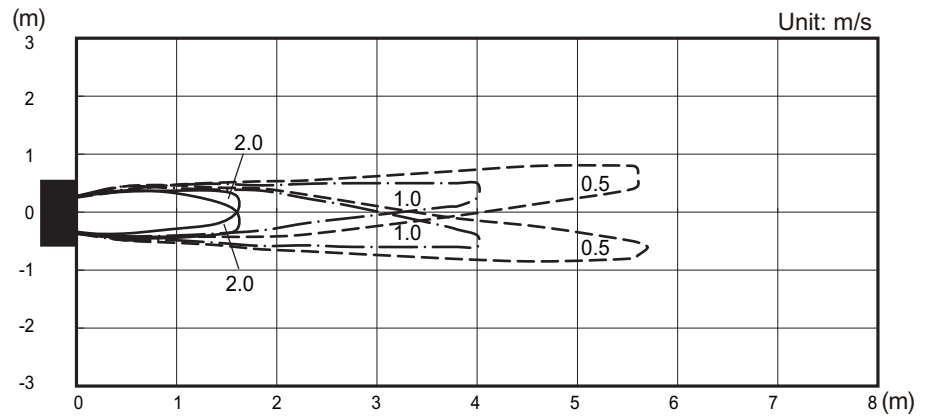

Side view
Horizontal louver: Up
Vertical louver: Center

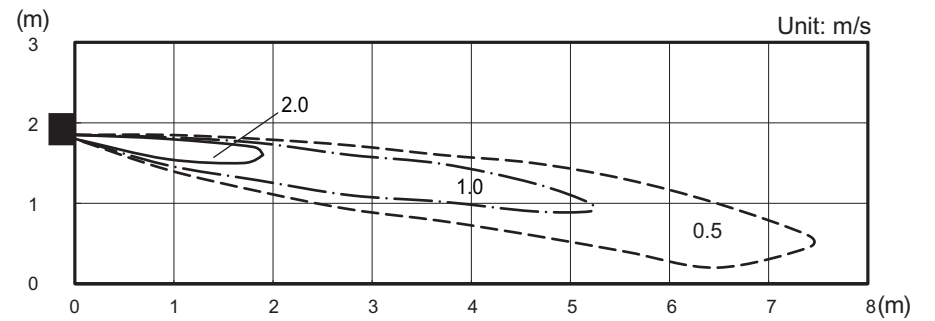

Side view
Horizontal louver: Down
Vertical louver: Center

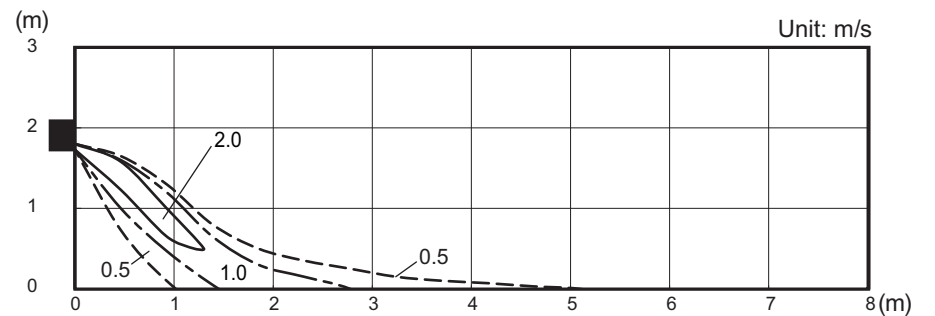

Model: ASEH07KNCA

Measuring conditions	Fan speed	Operation mode
	HIGH	FAN

2-UNIT
MULTI-SPLIT TYPE

2-UNIT
MULTI-SPLIT TYPE

Top view
Horizontal louver: Up
Vertical louver: Center

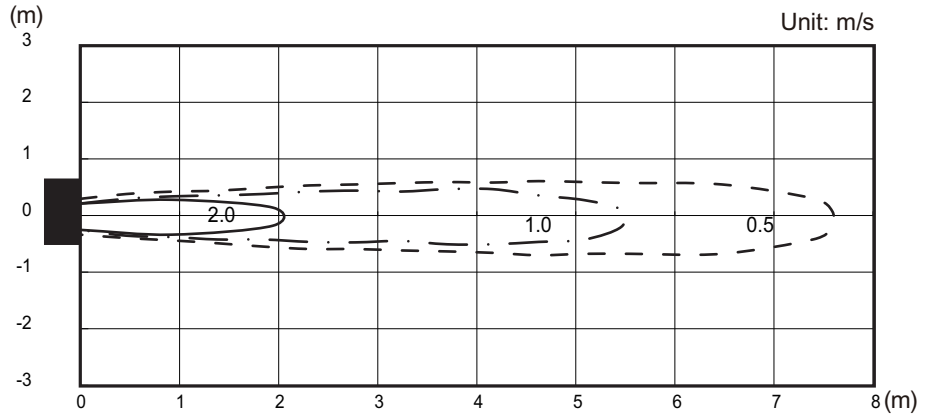

Top view
Horizontal louver: Up
Vertical louver: Left & Right

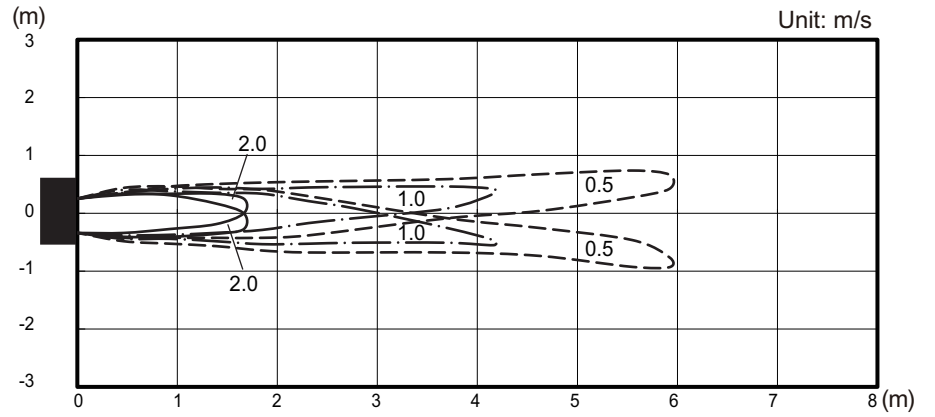

Side view
Horizontal louver: Up
Vertical louver: Center

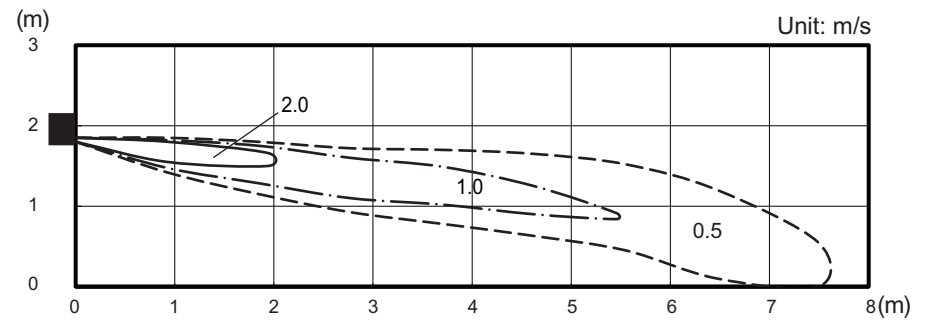

Side view
Horizontal louver: Down
Vertical louver: Center

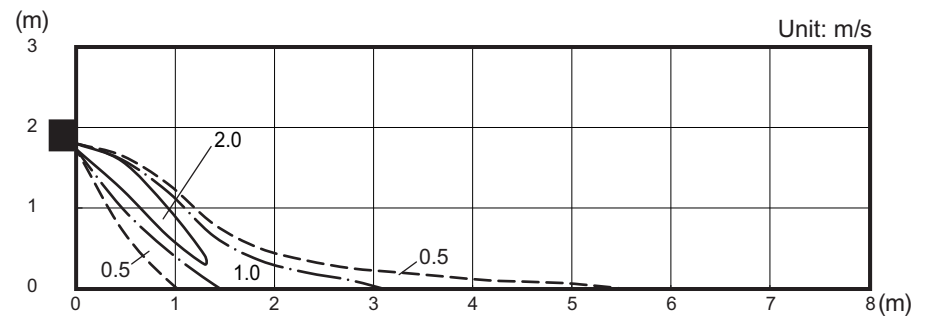

Model: ASEH09KNCA

Measuring conditions	Fan speed	Operation mode
	HIGH	FAN

2-UNIT
MULTI-SPLIT TYPE

2-UNIT
MULTI-SPLIT TYPE

Top view
Horizontal louver: Up
Vertical louver: Center

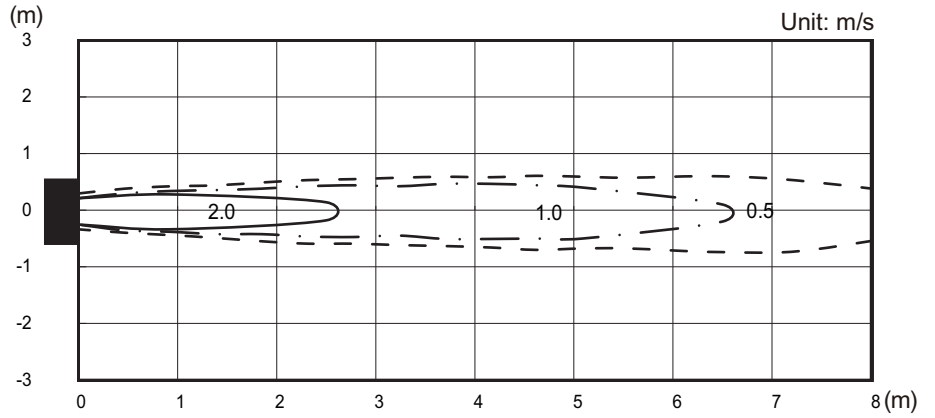

Top view
Horizontal louver: Up
Vertical louver: Left & Right

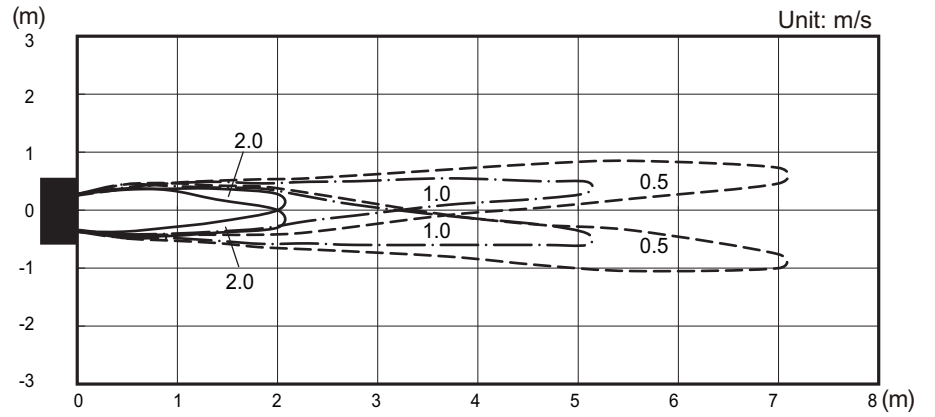

Side view
Horizontal louver: Up
Vertical louver: Center

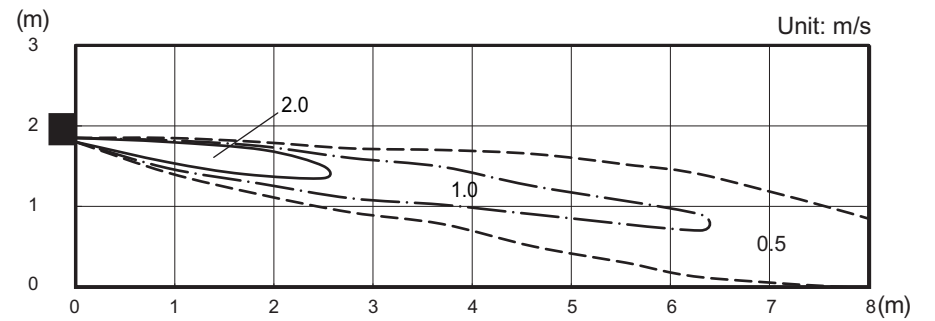

Side view
Horizontal louver: Down
Vertical louver: Center

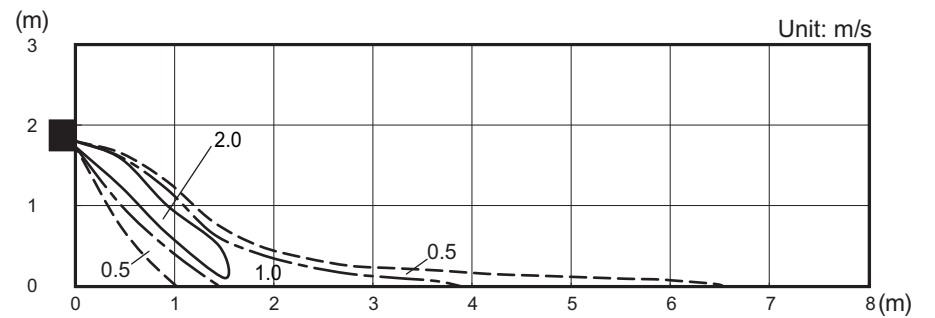

Model: ASEH12KNCA

Measuring conditions	Fan speed	Operation mode
	HIGH	FAN

2-UNIT
MULTI-SPLIT TYPE

2-UNIT
MULTI-SPLIT TYPE

Top view
Horizontal louver: Up
Vertical louver: Center

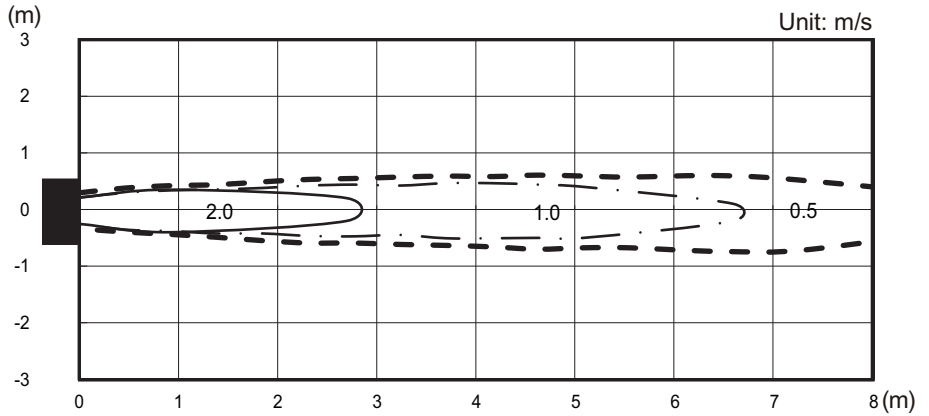

Top view
Horizontal louver: Up
Vertical louver: Left & Right

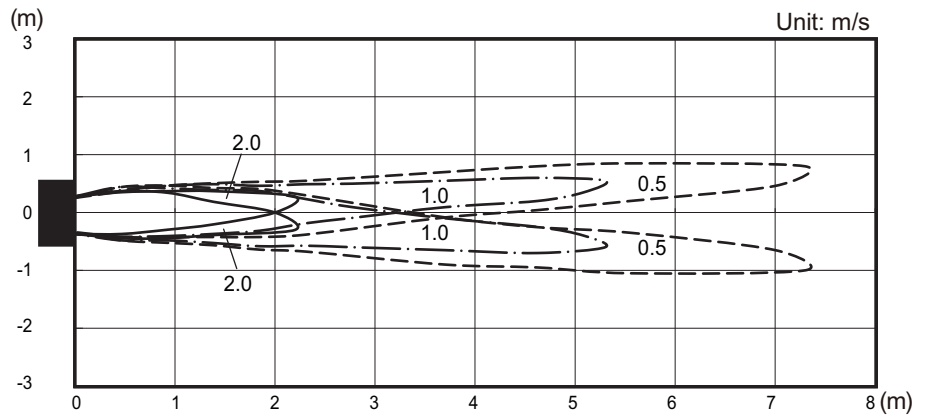

Side view
Horizontal louver: Up
Vertical louver: Center

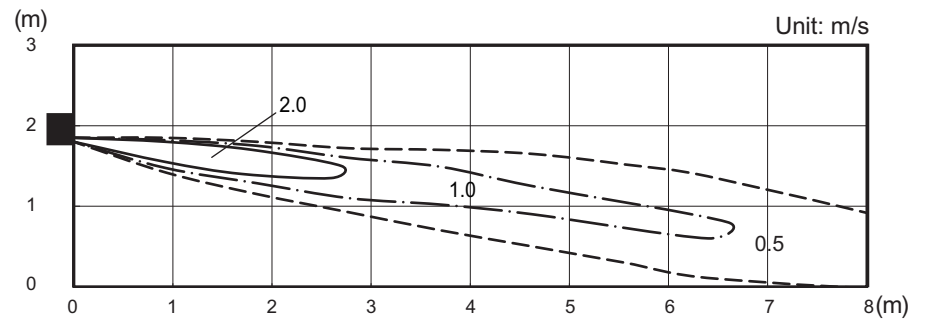

Side view
Horizontal louver: Down
Vertical louver: Center

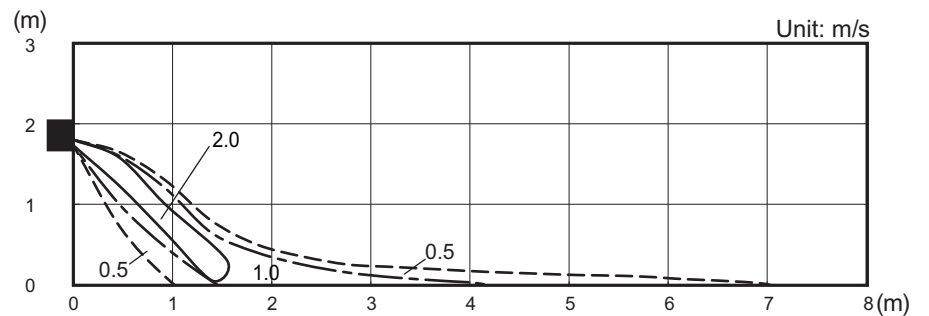

6-5. Floor type

Models: AGEG09-14KVCA

Measuring conditions	Fan speed	Operation mode	Fan select
	HIGH	FAN	Upper and lower

Top view
Horizontal louver: Up
Vertical louver: Center

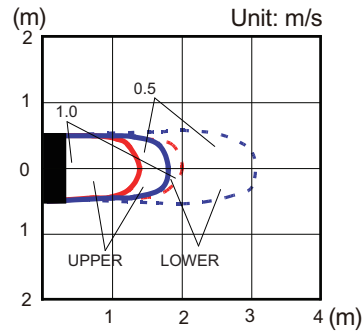

Top view
Horizontal louver: Up
Vertical louver: Left & Right

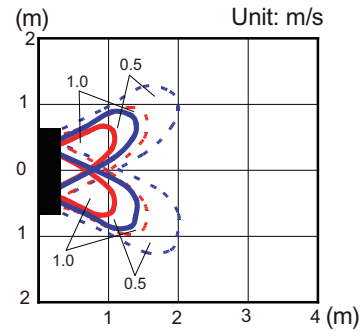

Side view
Horizontal louver: Up
Vertical louver: Center

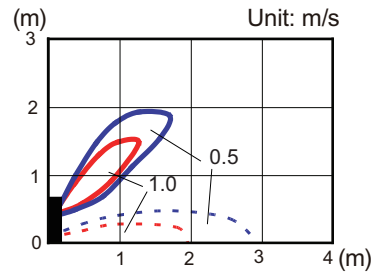

Side view
Horizontal louver: Down
Vertical louver: Center

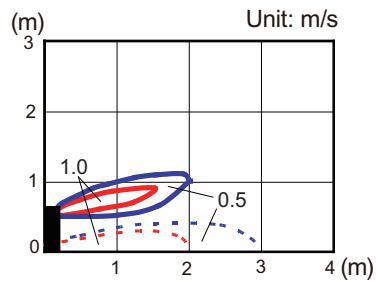

7. Fan performance

NOTE: Airflow and capacity/outlet temperature curve data are measured based on the same conditions mentioned in "Specifications".

7-1. Mini duct type

Model: ARXG07KSLAP

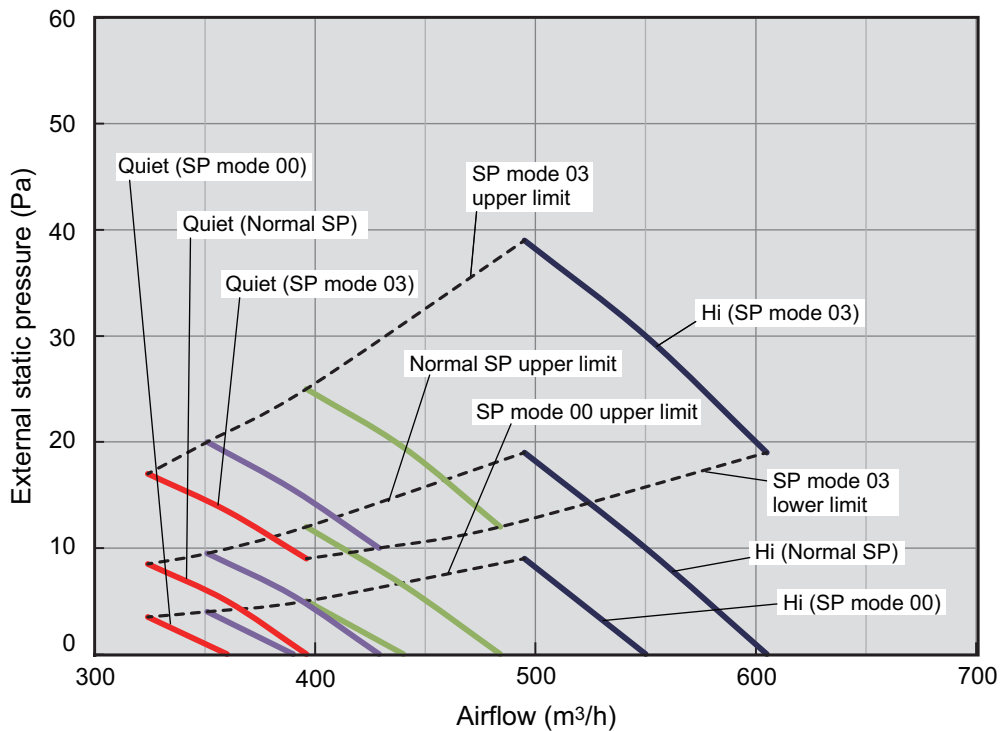

Available airflow rate range (High level)

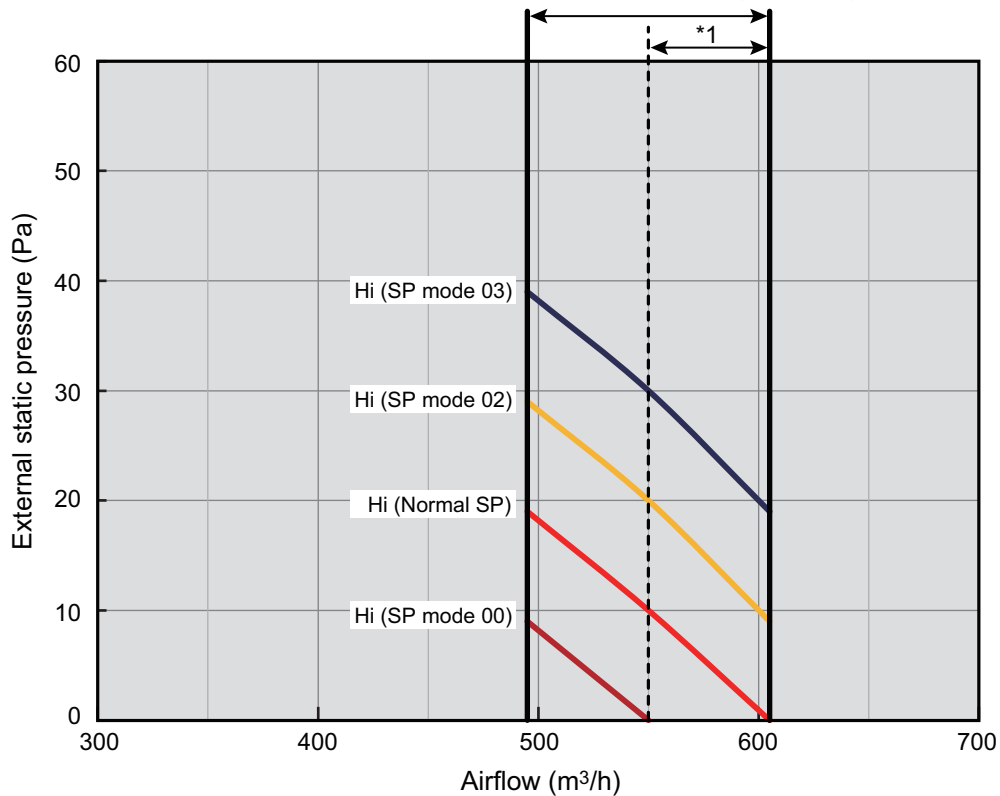

*1: Available airflow rate range when Auto louver grille (option) is installed.
 Fan speed: HIGH
 Vertical airflow direction louver: Up

● Characteristics of air volume and capacity

• Cooling

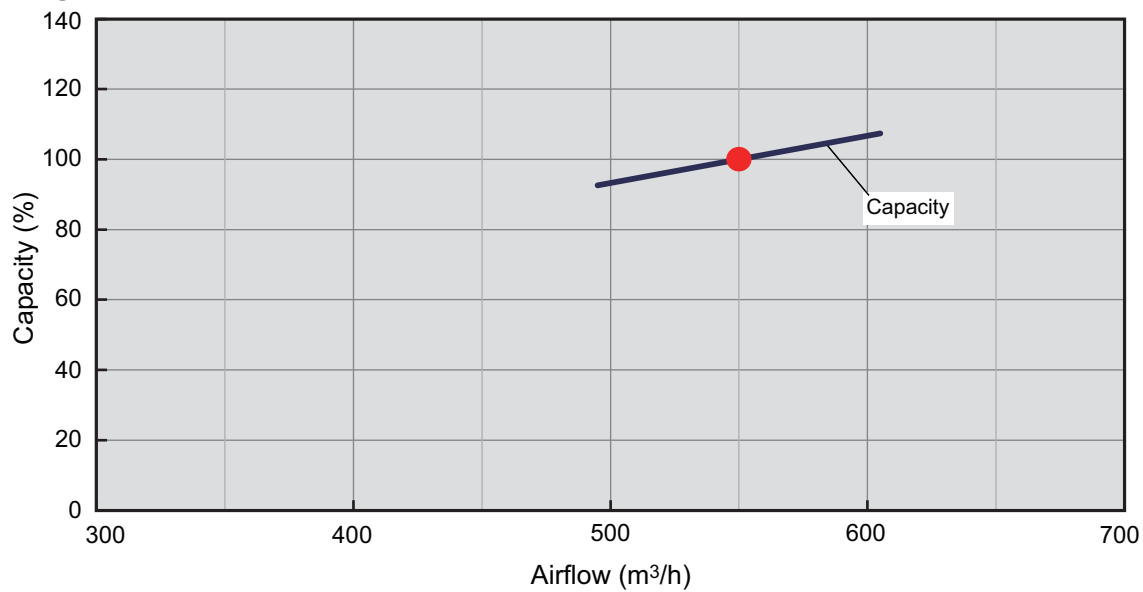

• Heating

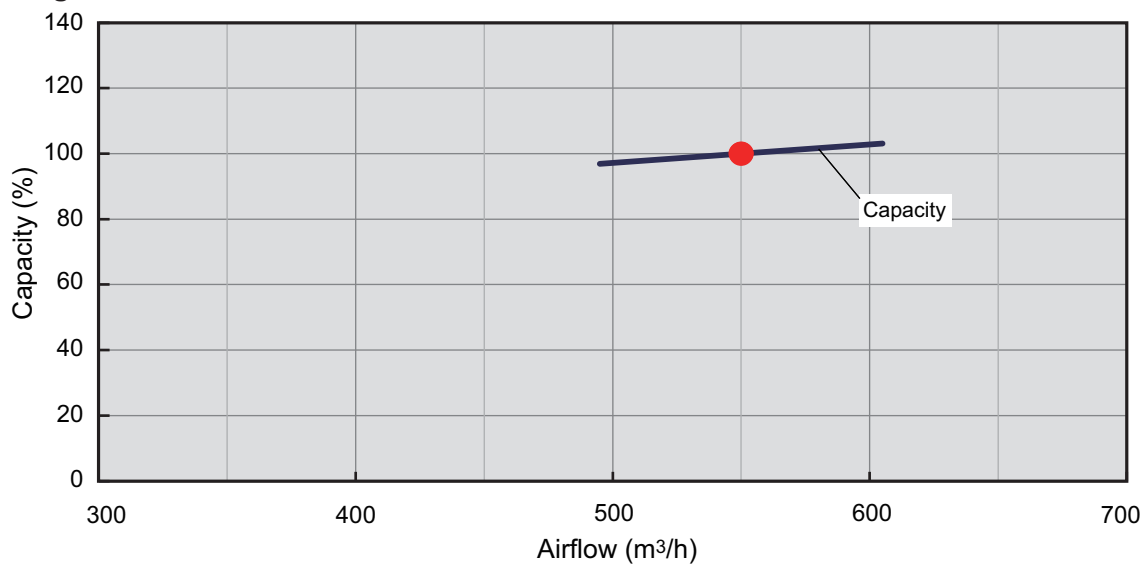

■ Model: ARXG09KSLAP

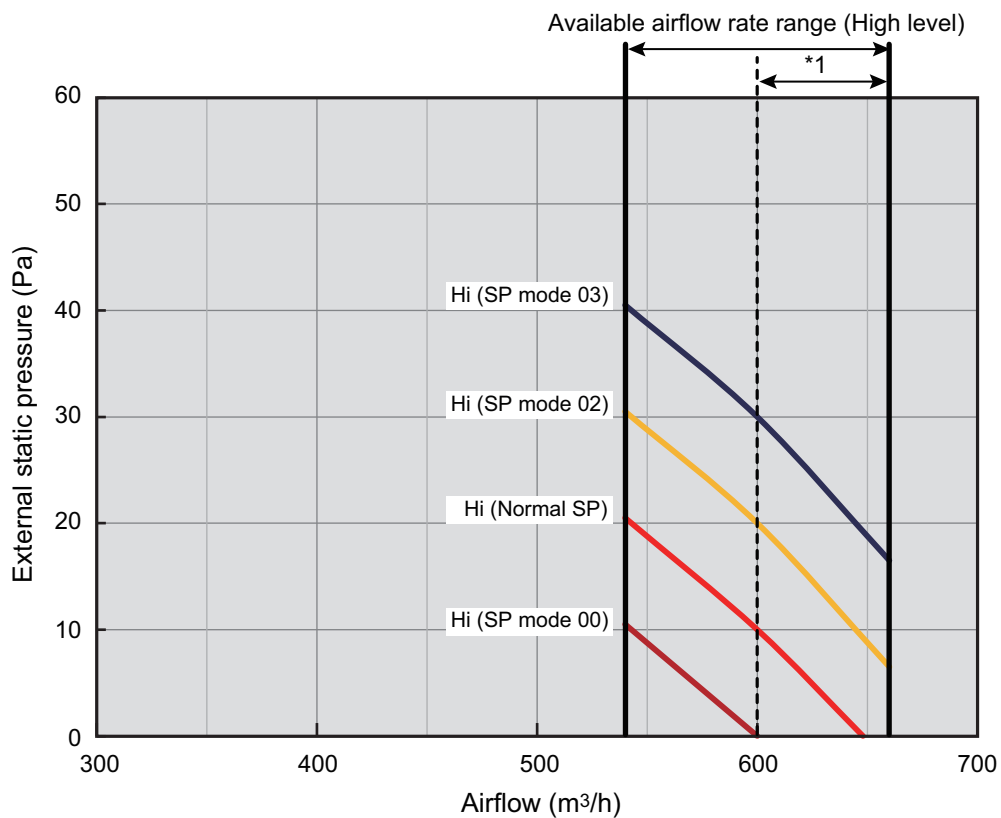
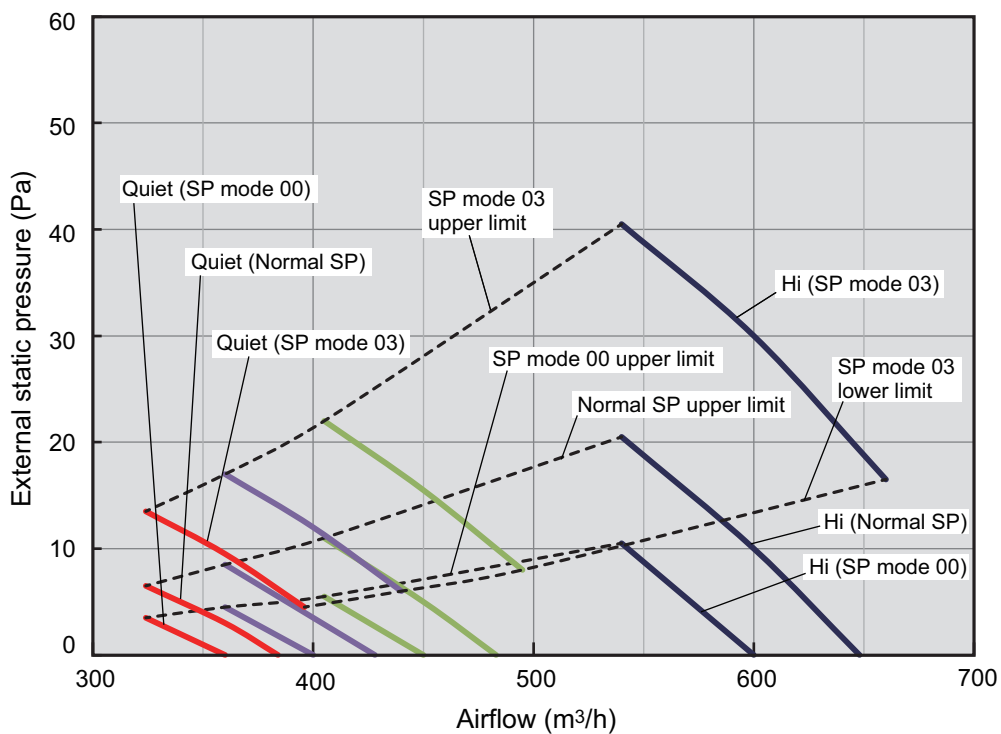

*1: Available airflow rate range when Auto louver grille (option) is installed.
 Fan speed: HIGH
 Vertical airflow direction louver: Up

● Characteristics of air volume and capacity

• Cooling

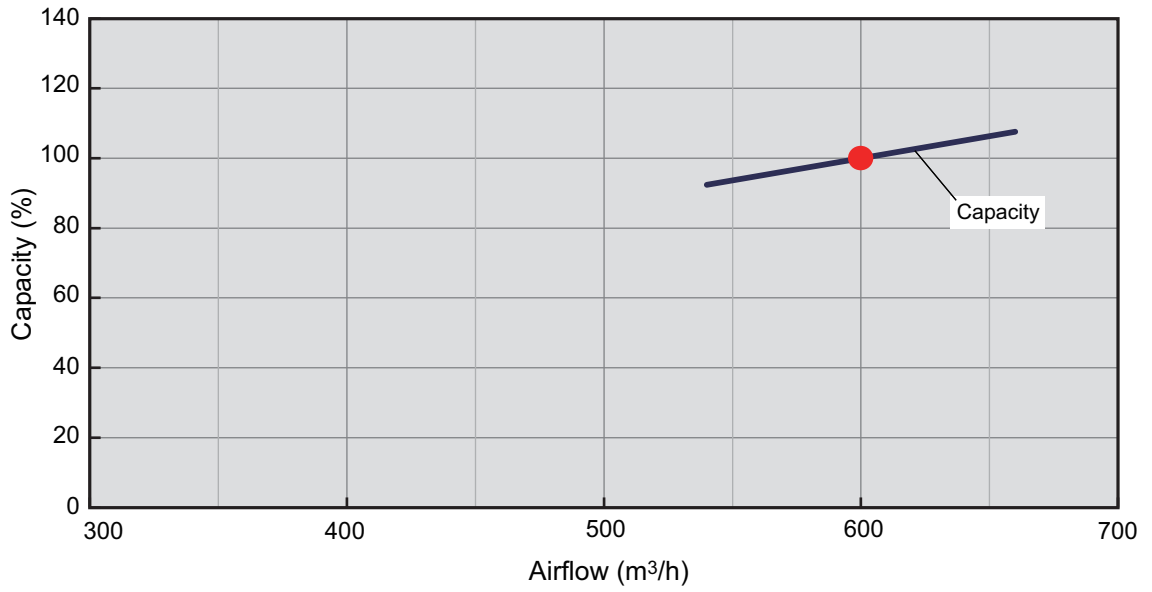

• Heating

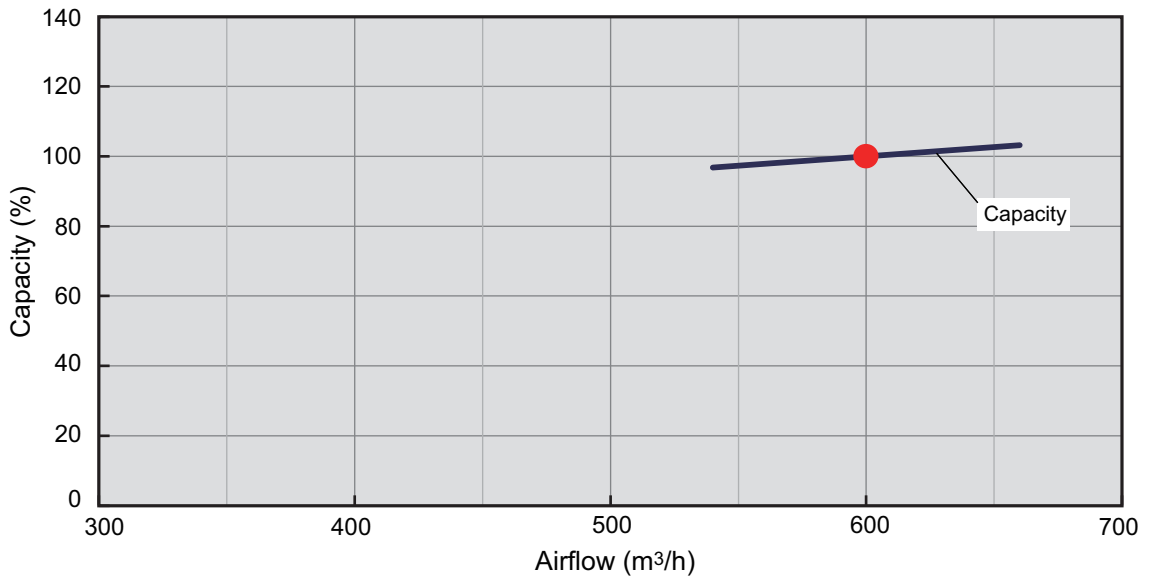

Model: ARXG12KSLAP

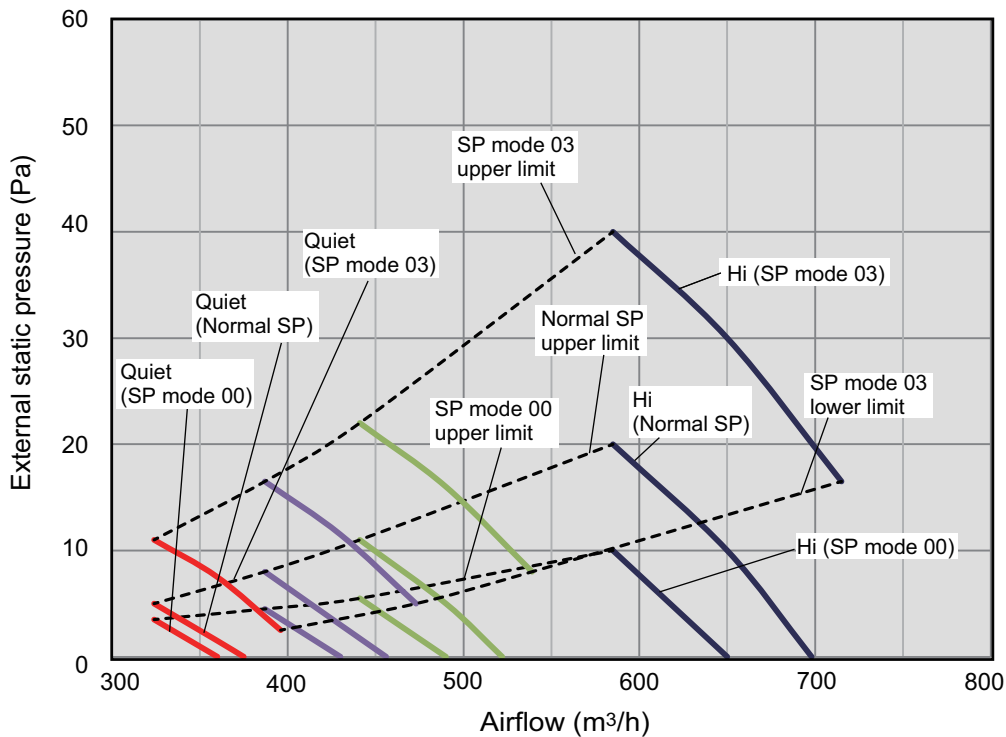

Available airflow rate range (High level)

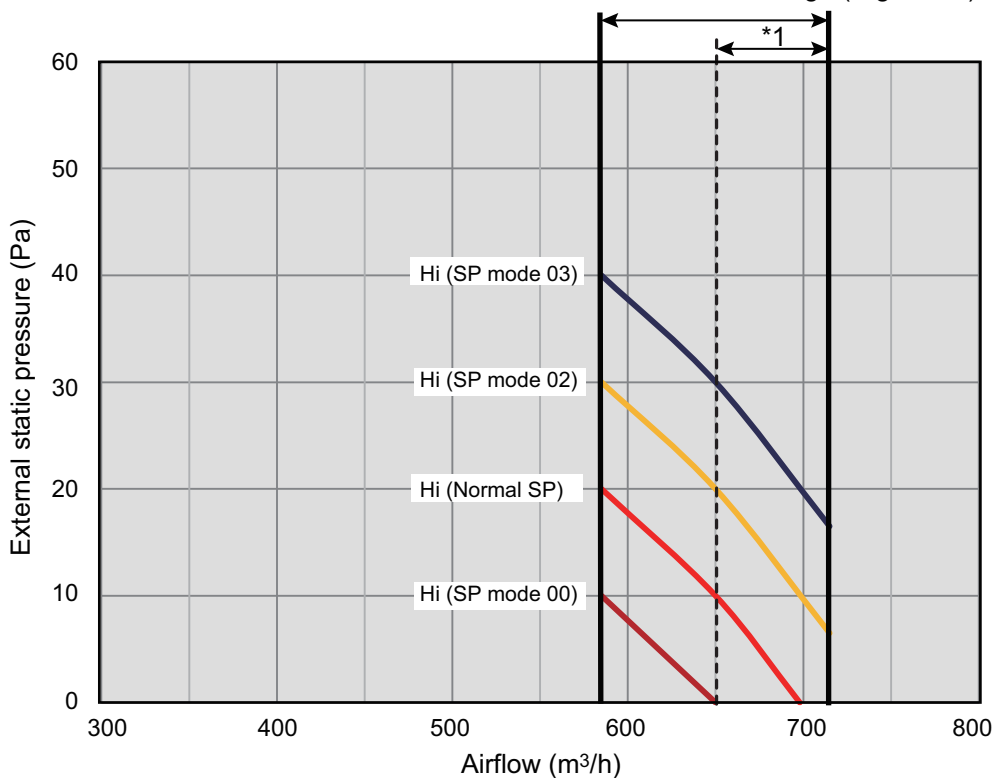

*1: Available airflow rate range when Auto louver grille (option) is installed.

Fan speed: HIGH

Vertical airflow direction louver: Up

● Characteristics of air volume and capacity

• Cooling

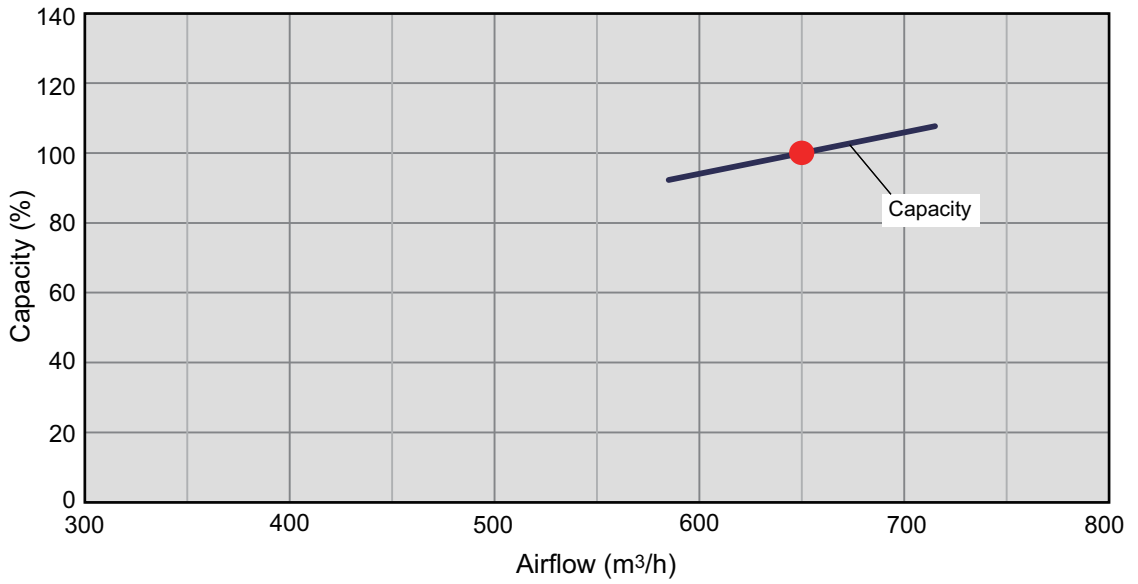

• Heating

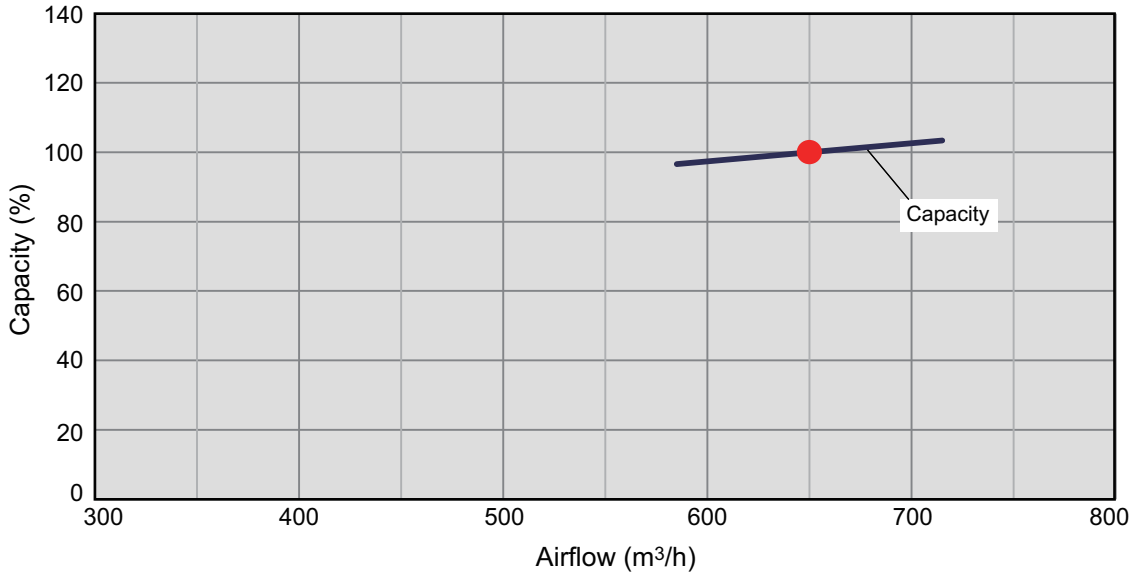

Model: ARXG14KSLAP

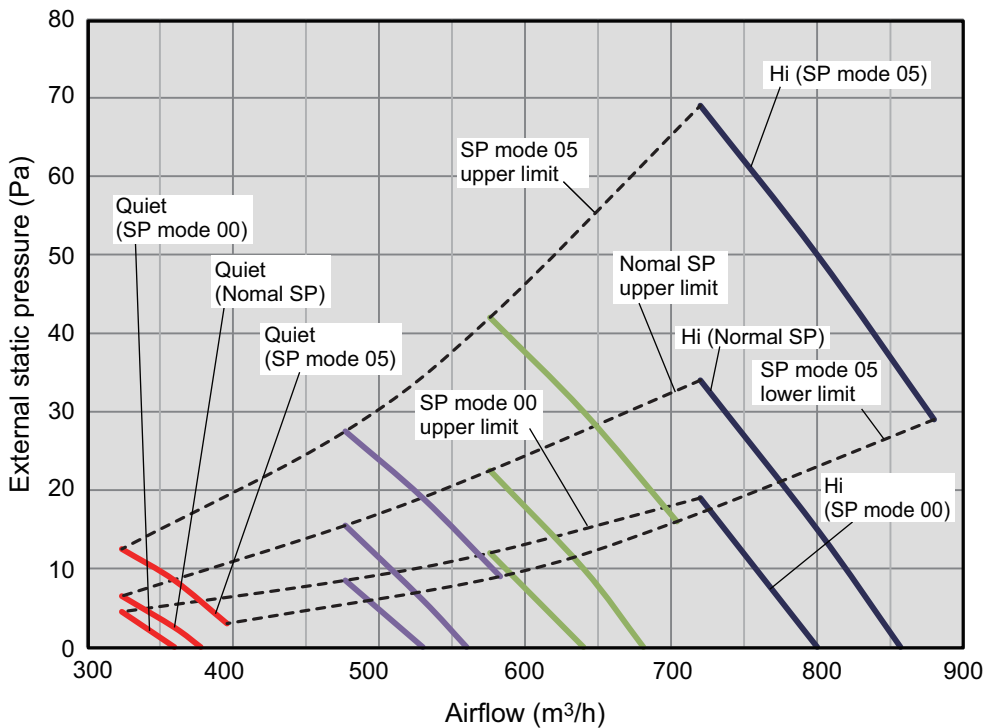

Available airflow rate range (High level)

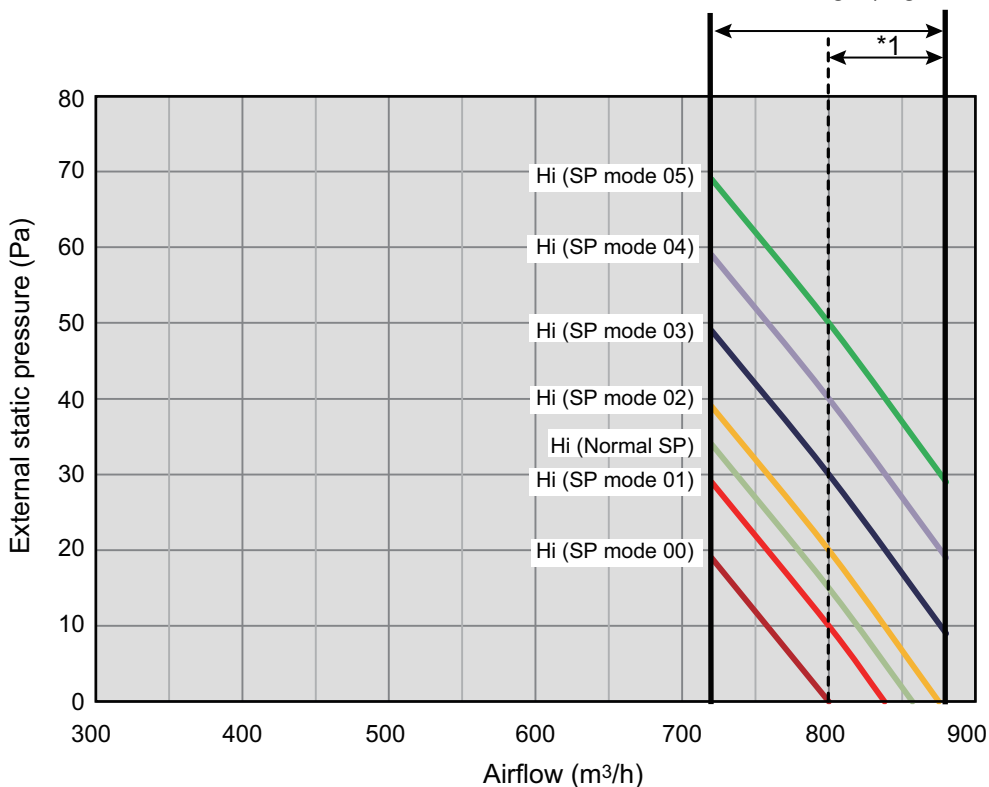

*1: Available airflow rate range when Auto louver grille (option) is installed.
 Fan speed: HIGH
 Vertical airflow direction louver: Up

● Characteristics of air volume and capacity

• Cooling

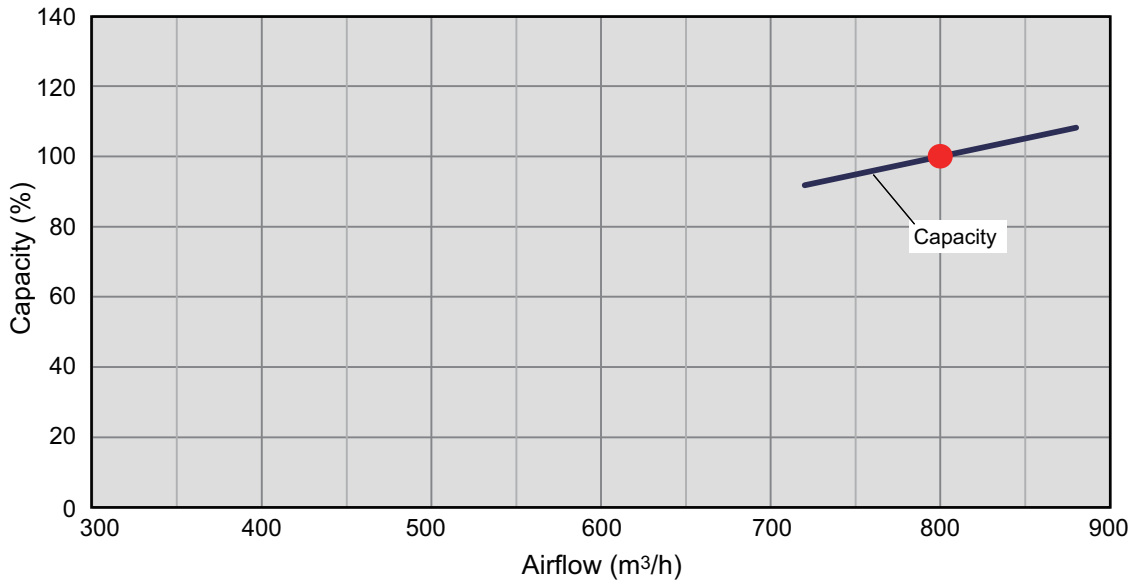

• Heating

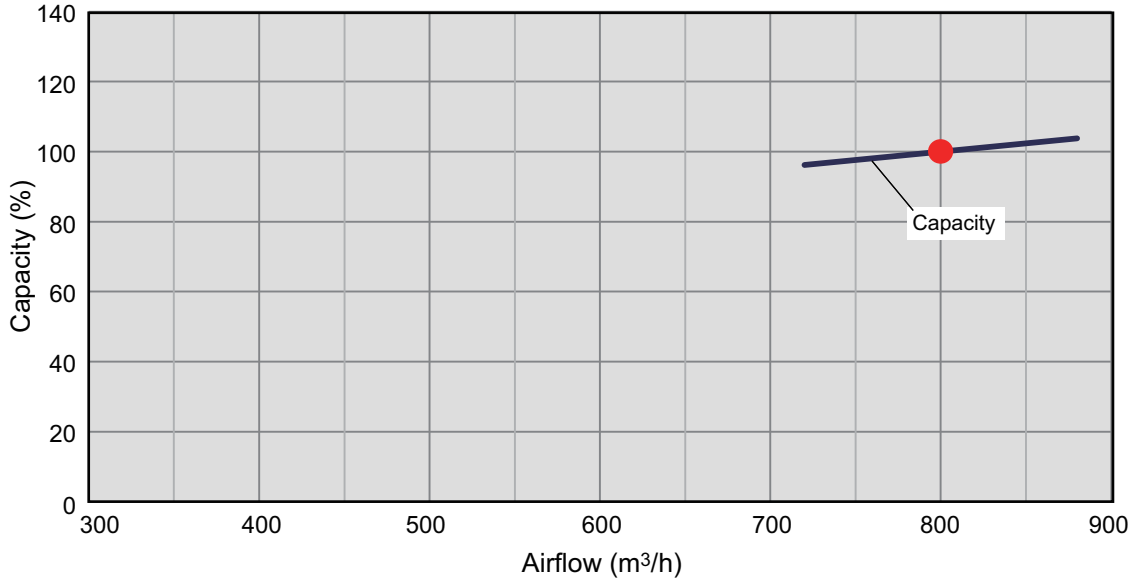

7-2. Slim duct type

Model: ARXG07KLLAP

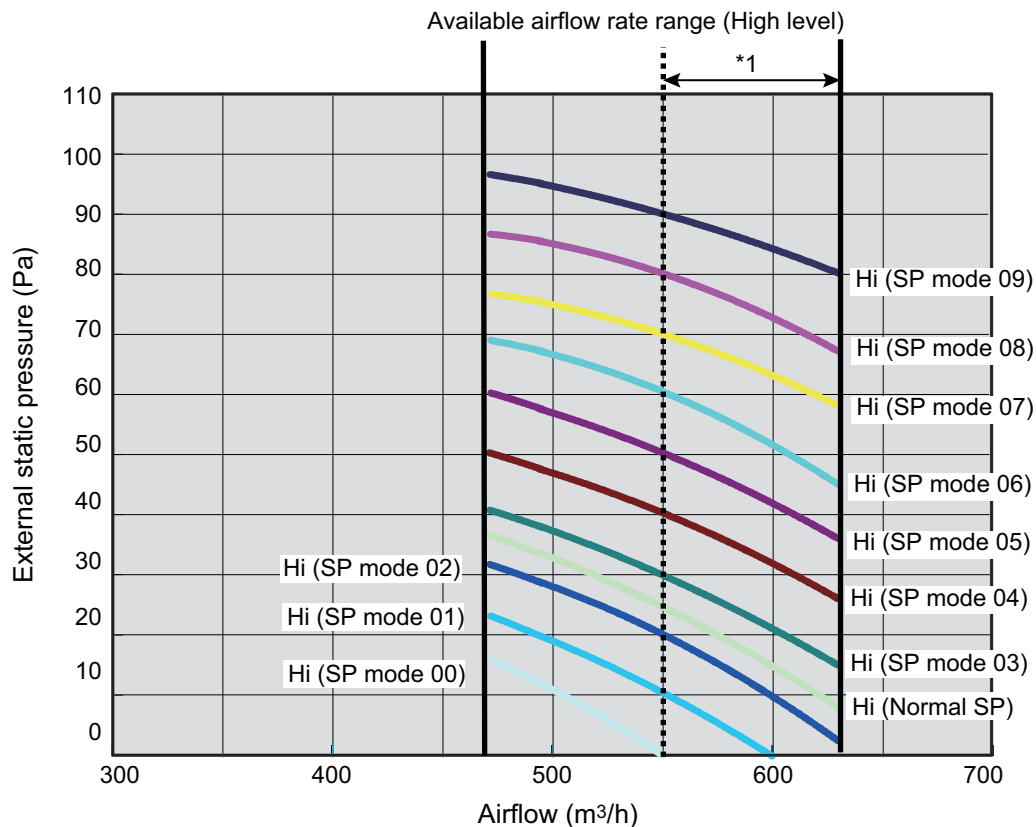
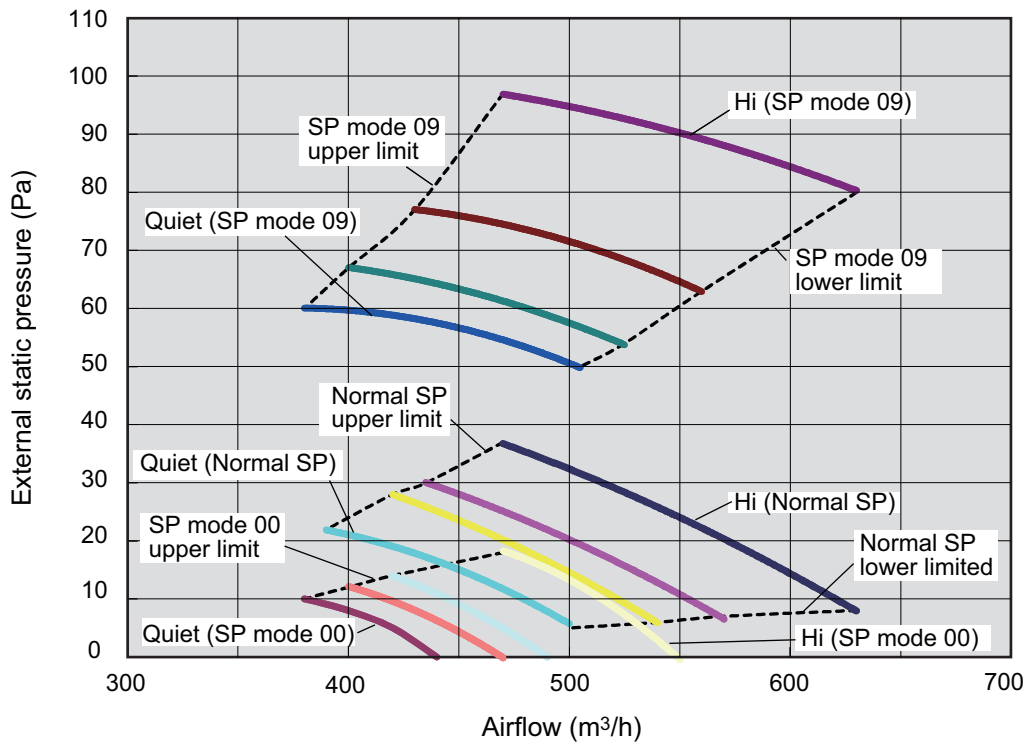

*1: Available airflow rate range when Auto louver grille (option) is installed.
 Fan speed: HIGH
 Vertical airflow direction louver: Up

● Characteristics of air volume and capacity

• Cooling

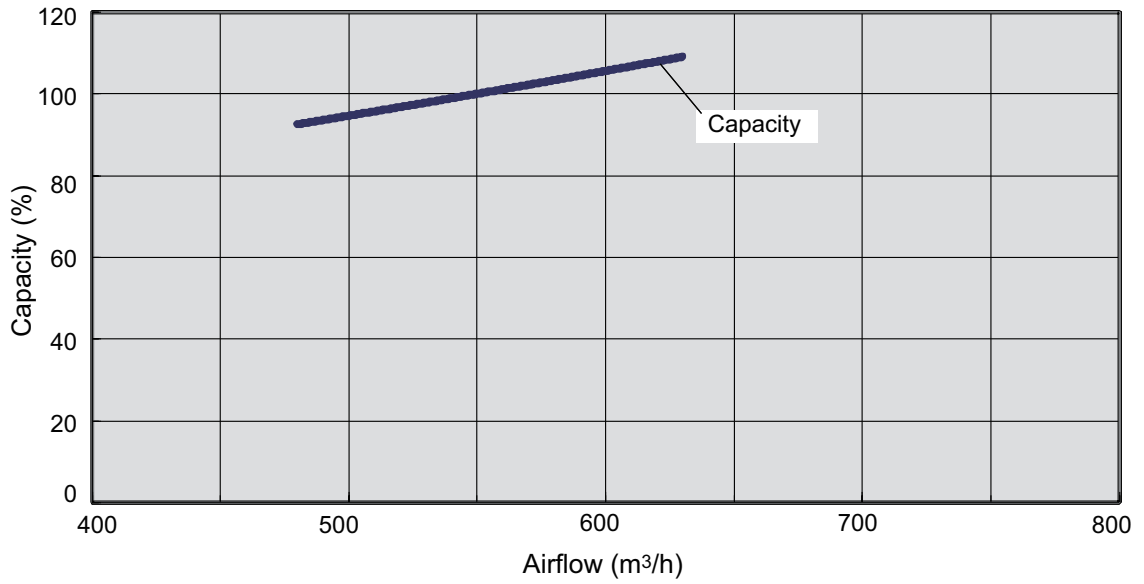

• Heating

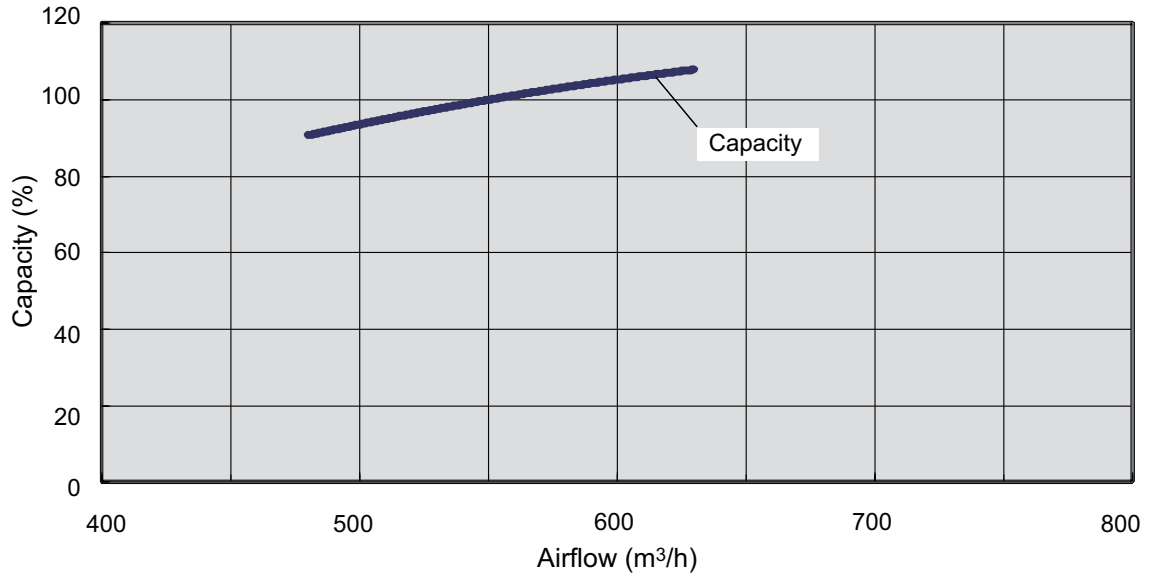

Model: ARXG09KLLAP

2-UNIT
MULTI-SPLIT TYPE

2-UNIT
MULTI-SPLIT TYPE

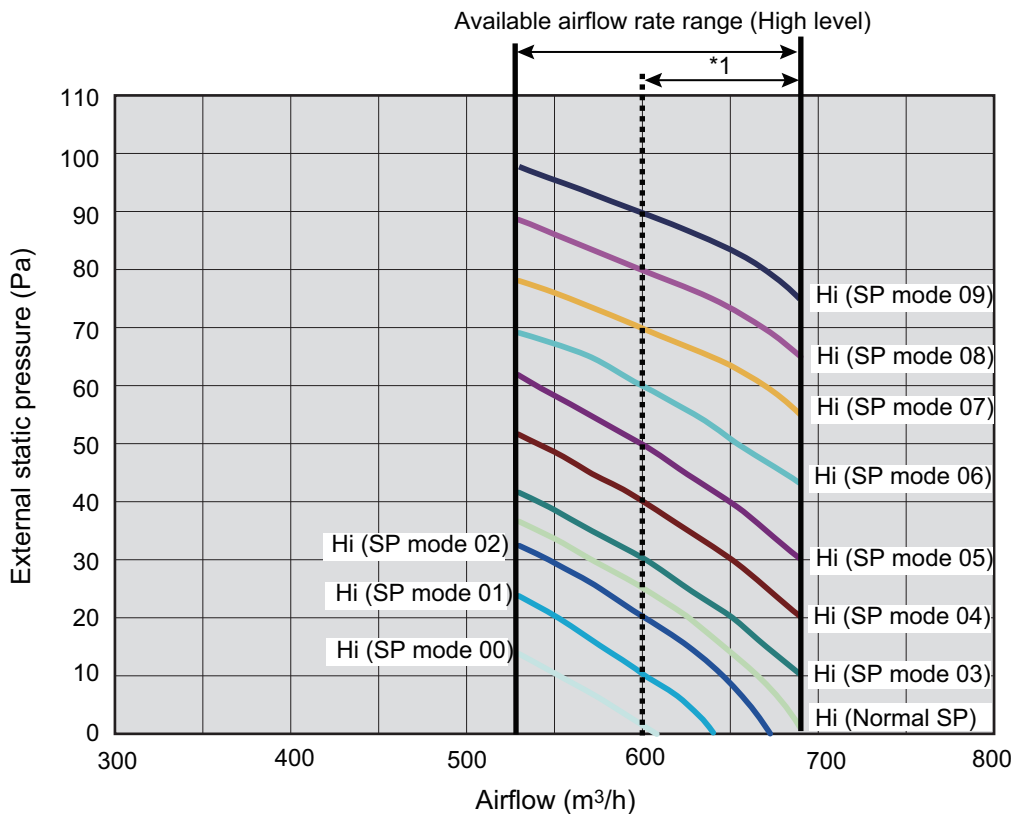
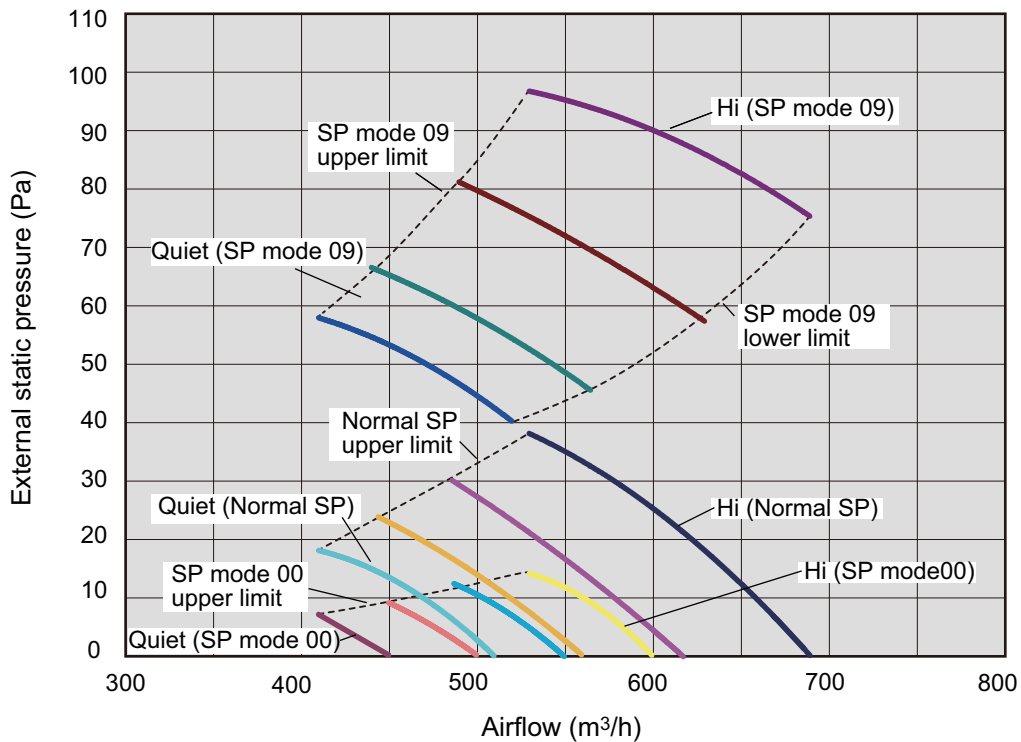

*1: Available airflow rate range when Auto louver grille (option) is installed.
 Fan speed: HIGH
 Vertical airflow direction louver: Up

● Characteristics of air volume and capacity

• Cooling

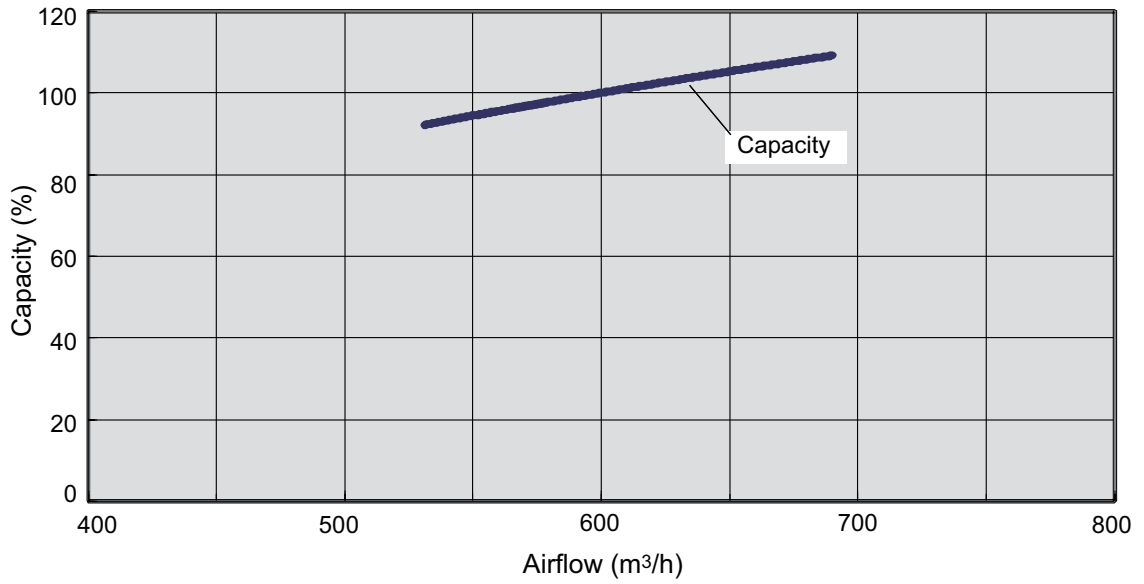

• Heating

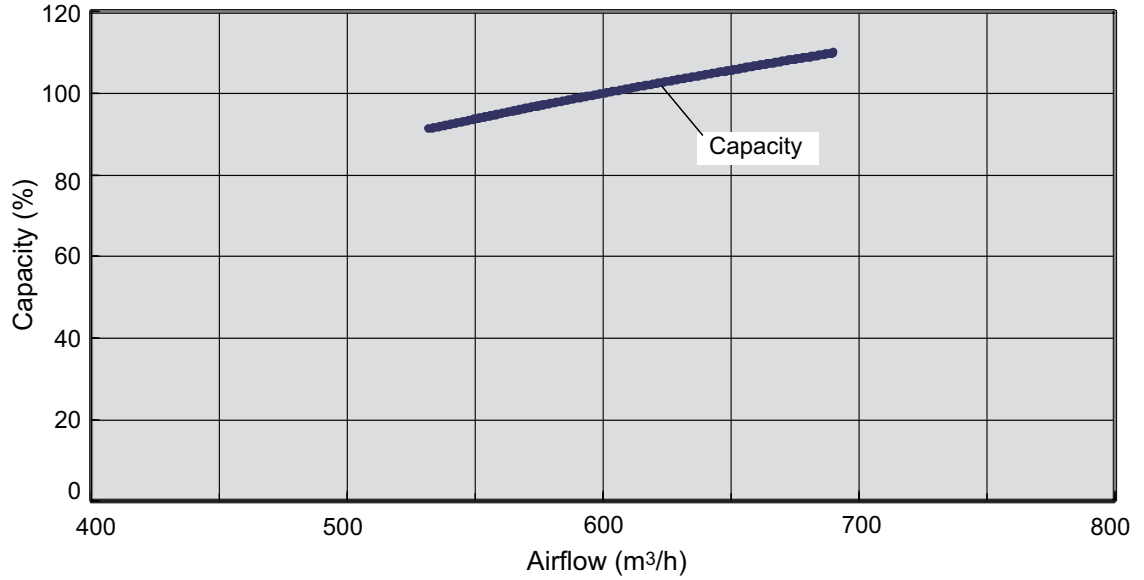

Model: ARXG12KLLAP

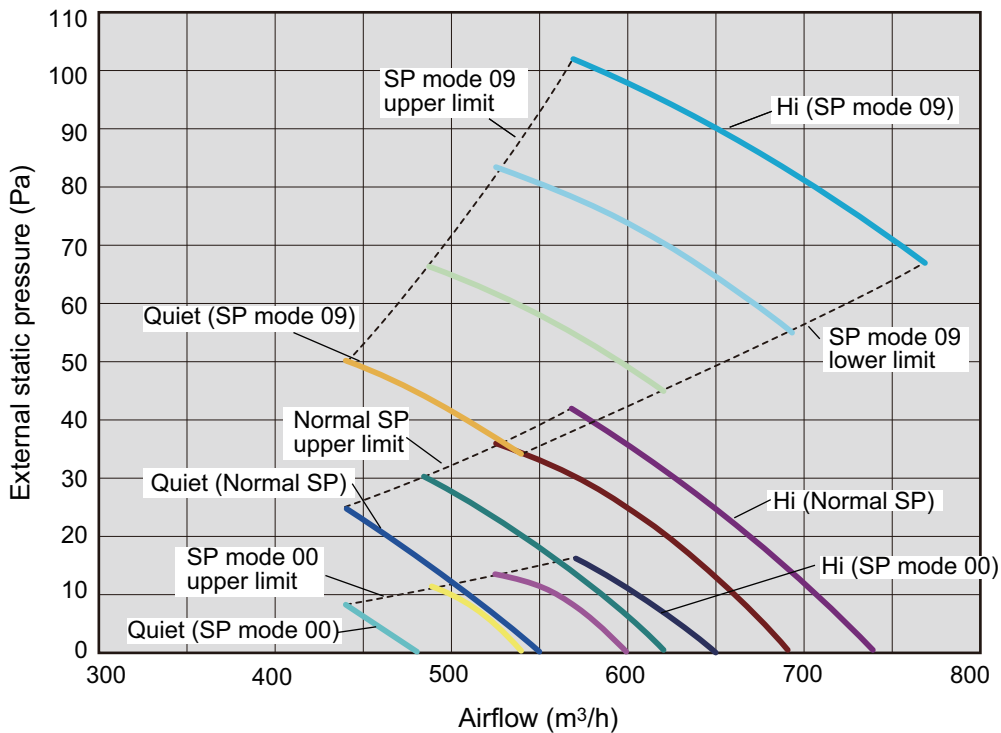

Available airflow rate range (High level)

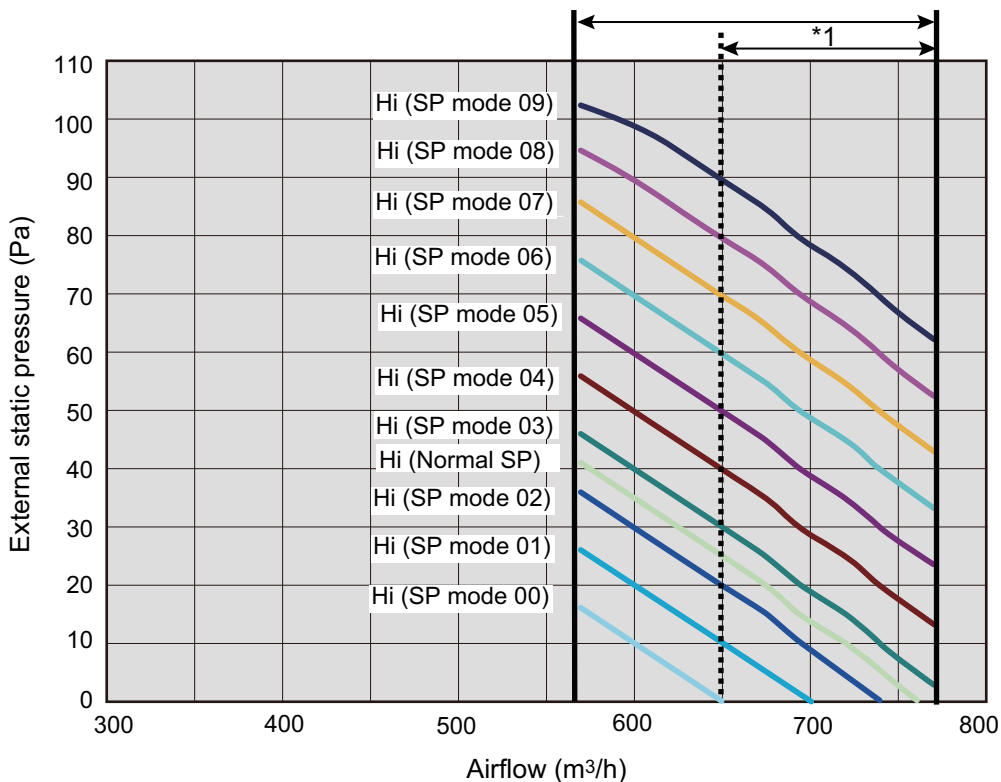

*1: Available airflow rate range when Auto louver grille (option) is installed.
 Fan speed: HIGH
 Vertical airflow direction louver: Up

● Characteristics of air volume and capacity

• Cooling

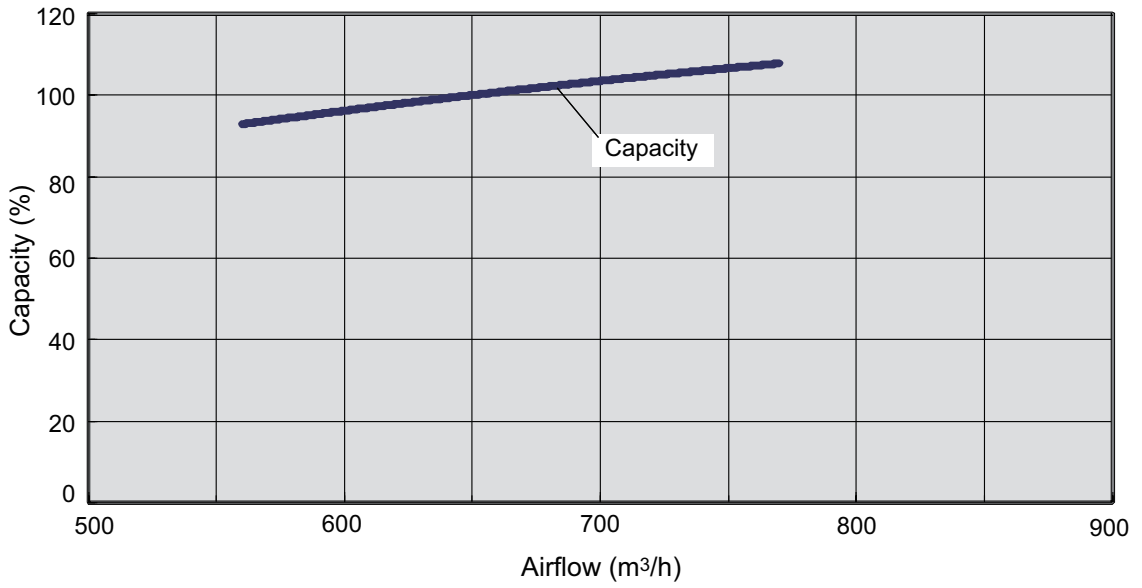

• Heating

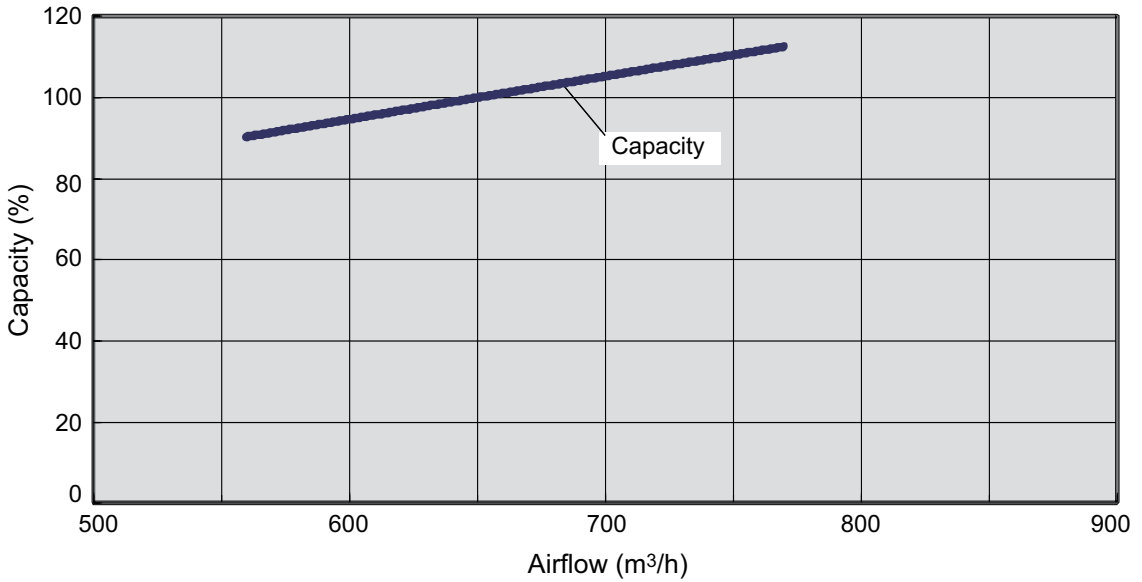

Model: ARXG14KLLAP

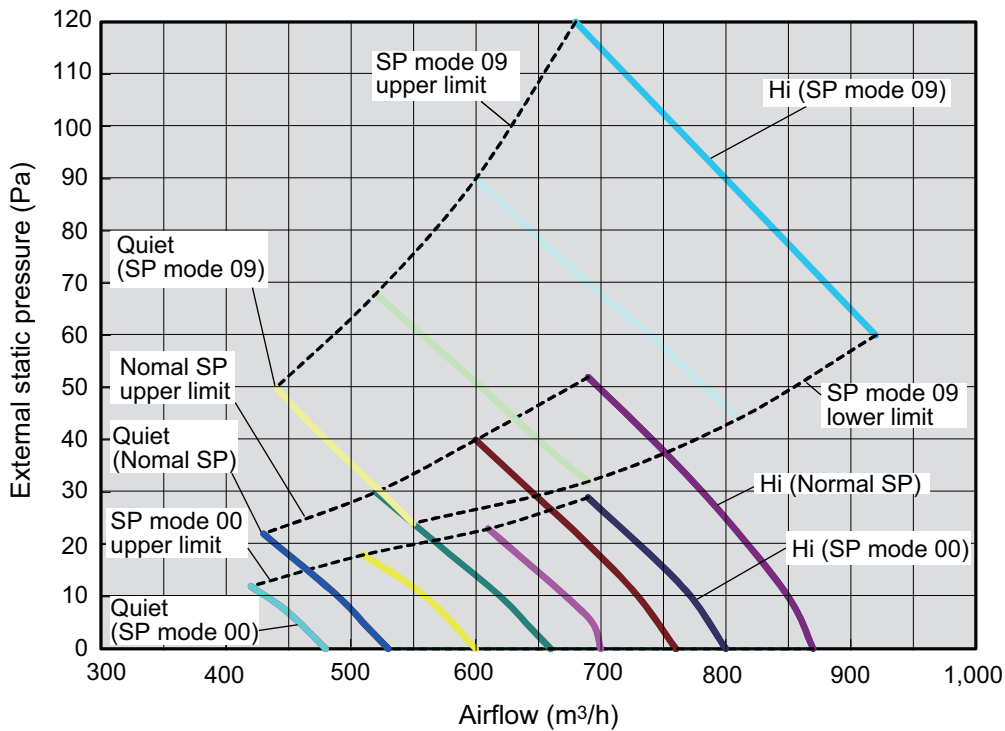

Available airflow rate range (High level)

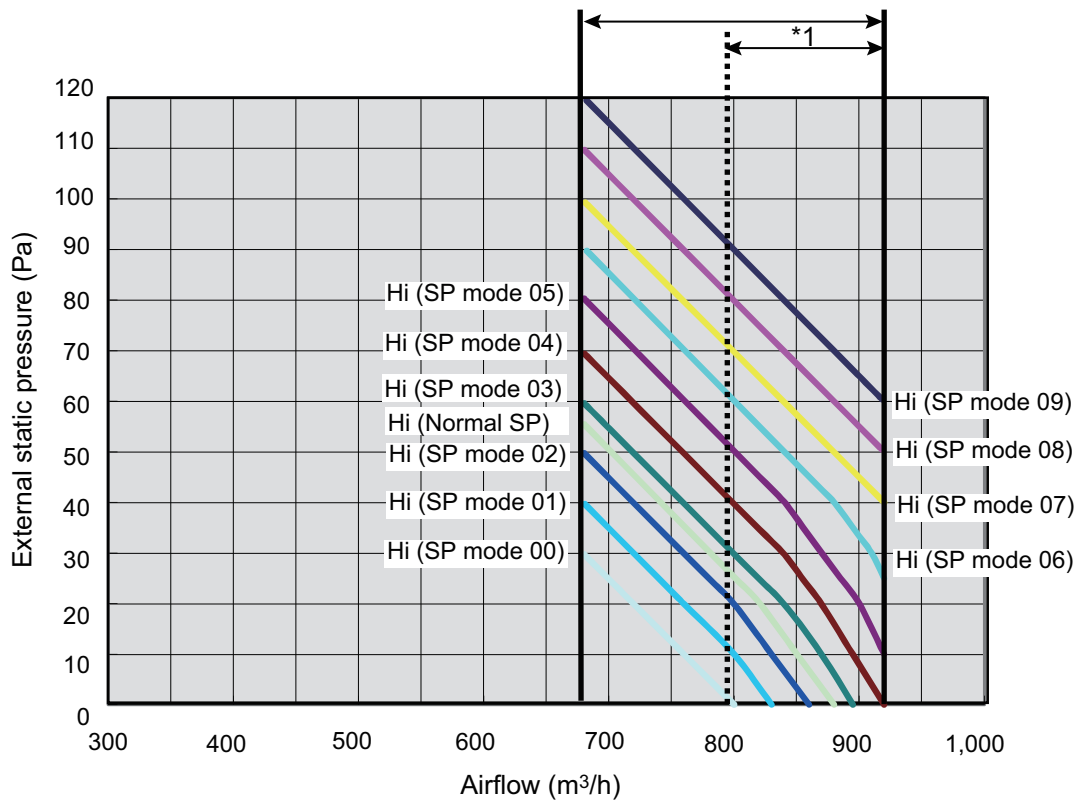

*1: Available airflow rate range when Auto louver grille (option) is installed.

Fan speed: HIGH

Vertical airflow direction louver: Up

● Characteristics of air volume and capacity

• Cooling

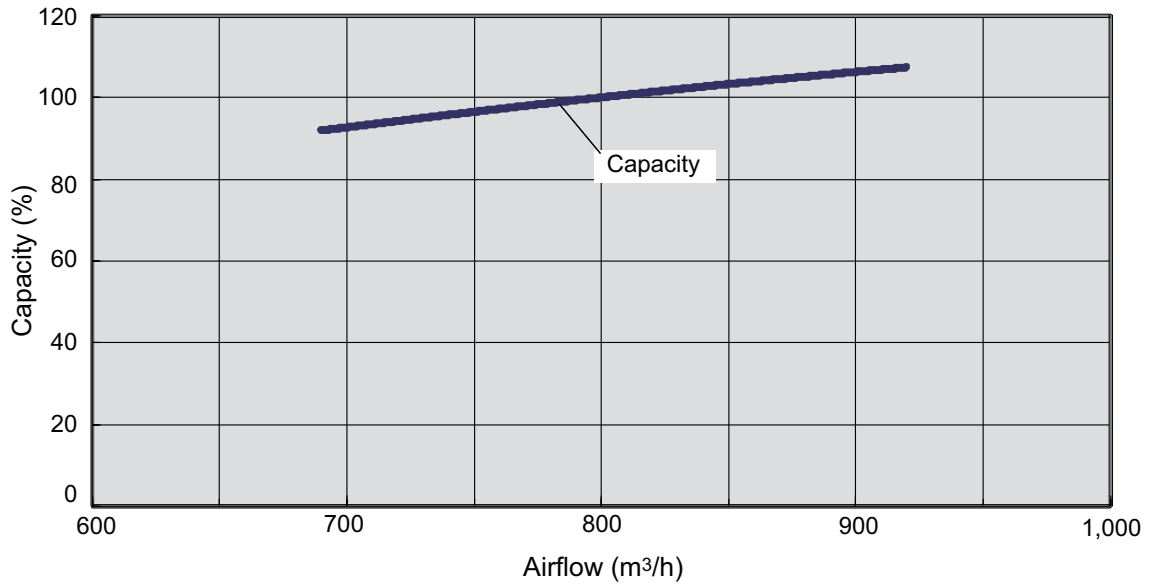

• Heating

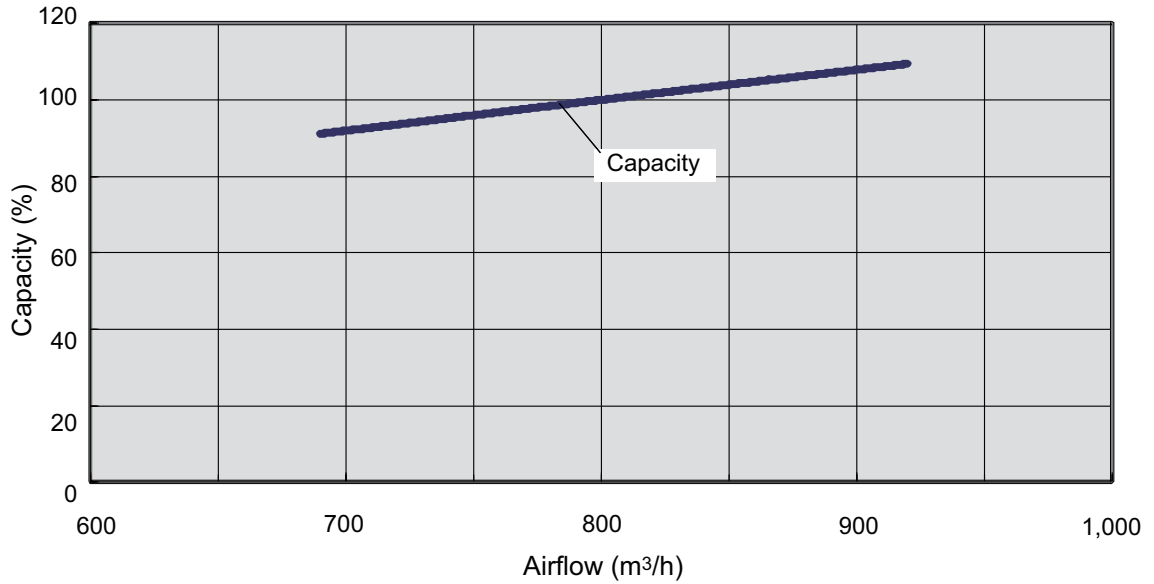

7-3. Medium static pressure duct type

Model: ARXH12KMTAP

Fan performance curve 1

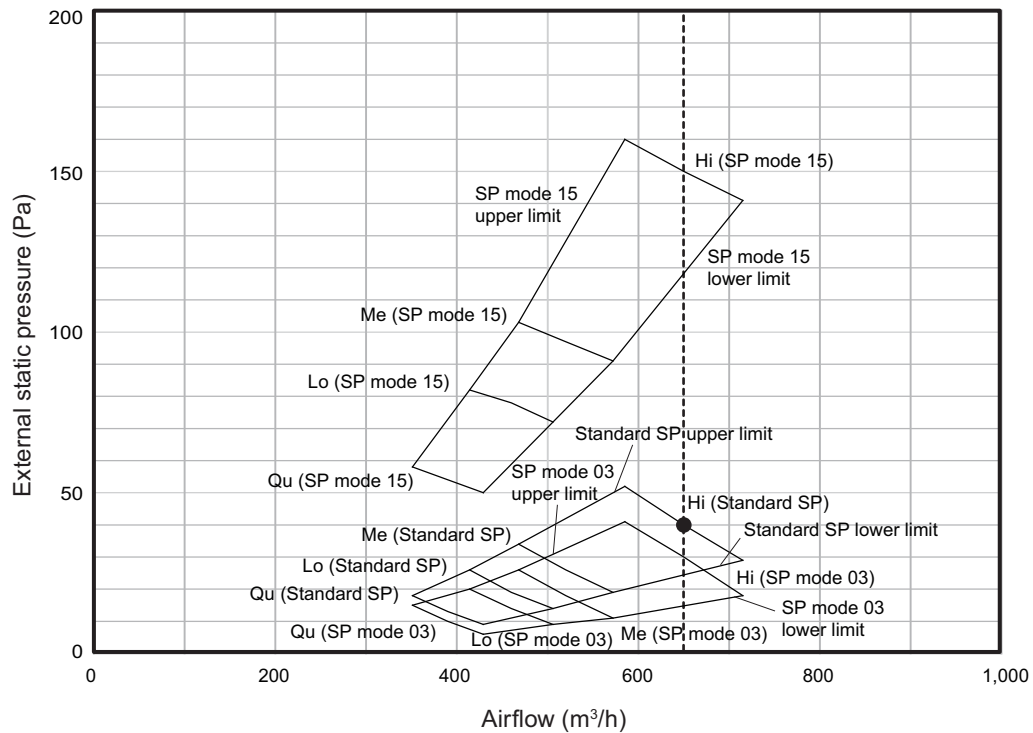

Fan performance curve 2
(For function setting by remote controller)

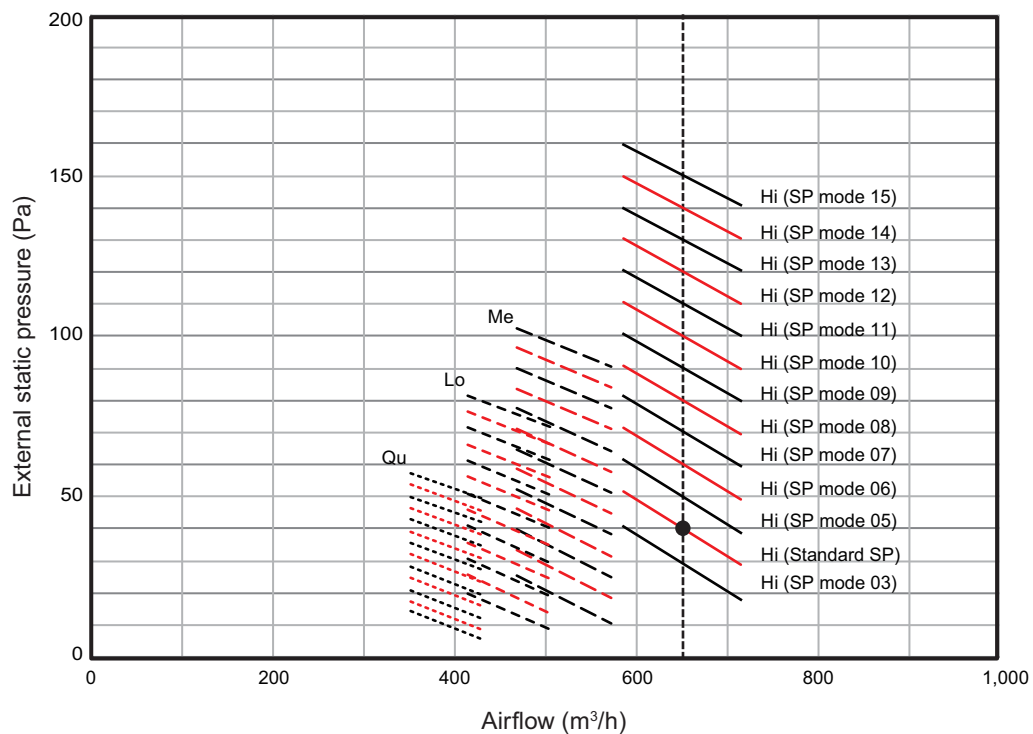

NOTES:

- Setting of the external static pressure is switchable into modes by using the remote controller.
- According to the resistance of the connecting duct, perform the setting of the external static pressure with referring “Fan performance curve 2” above.
- The default setting is set at “Standard SP”.

● Characteristics of air volume and capacity

• Cooling

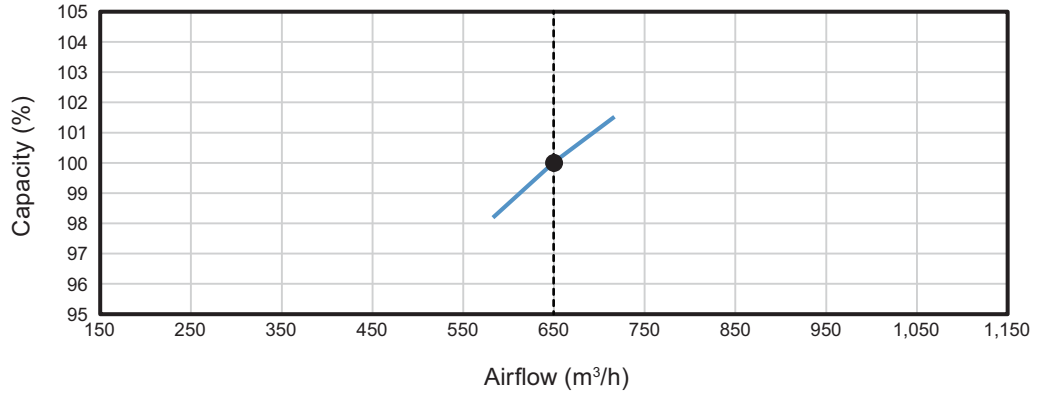

• Heating

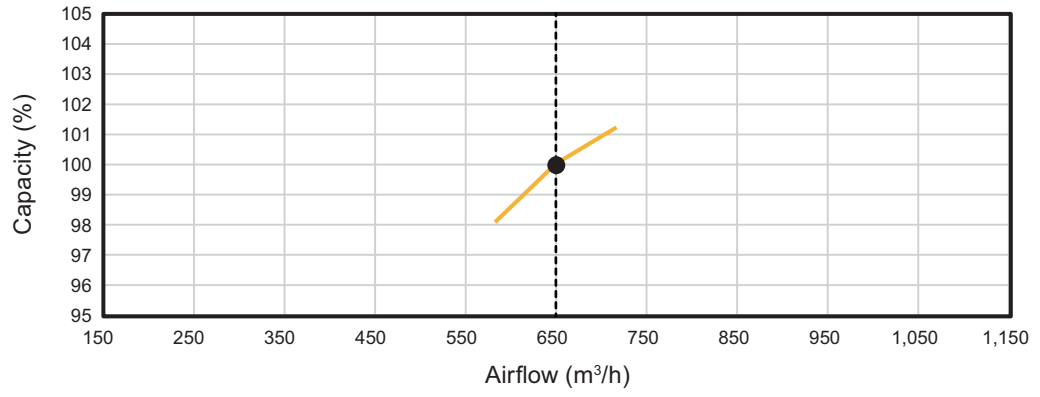

■ Model: ARXH14KMTAP

2-UNIT
MULTI-SPLIT TYPE

2-UNIT
MULTI-SPLIT TYPE

Fan performance curve 1

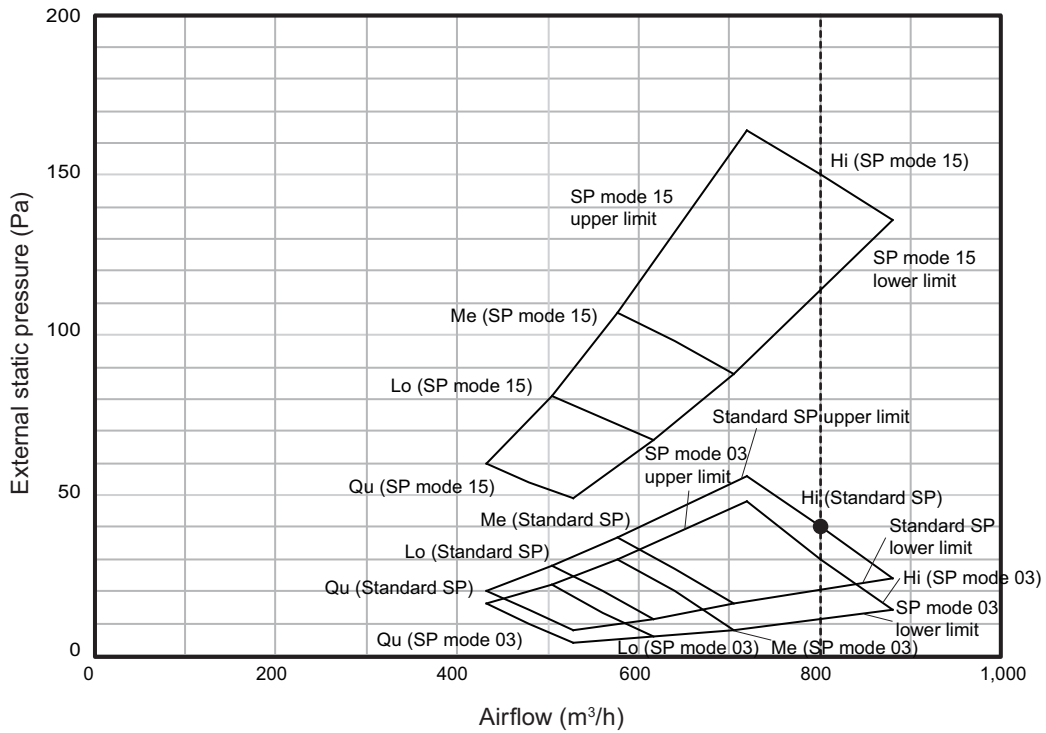

Fan performance curve 2
(For function setting by remote controller)

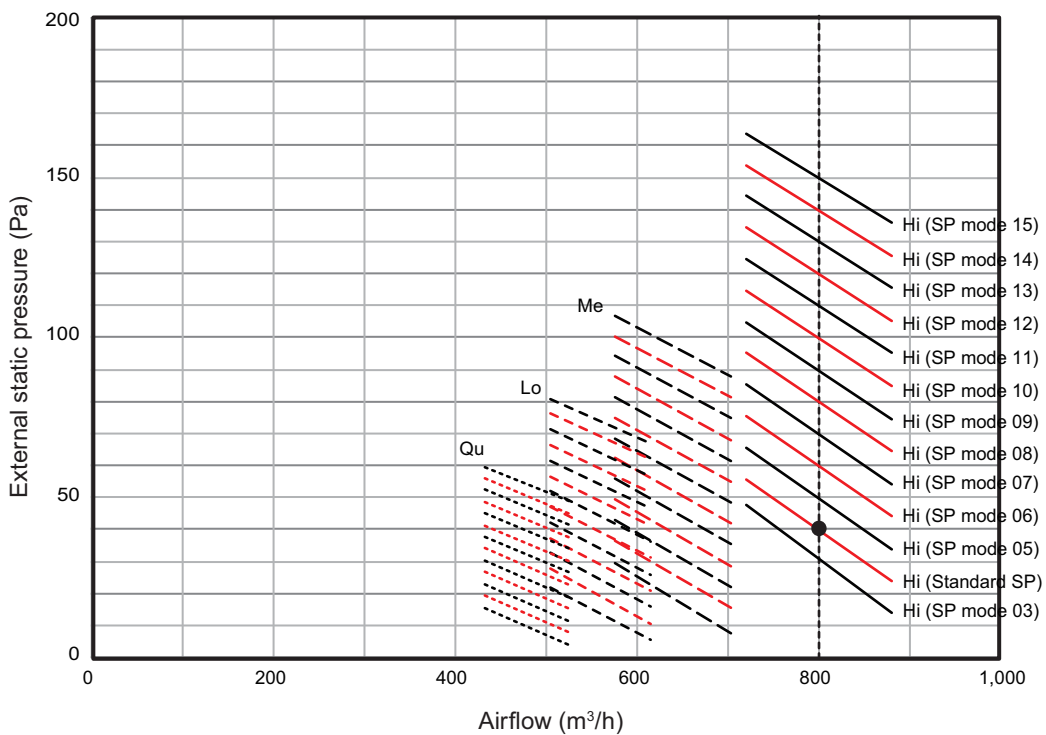

NOTES:

- Setting of the external static pressure is switchable into modes by using the remote controller.
- According to the resistance of the connecting duct, perform the setting of the external static pressure with referring “Fan performance curve 2” above.
- The default setting is set at “Standard SP”.

● Characteristics of air volume and capacity

• Cooling

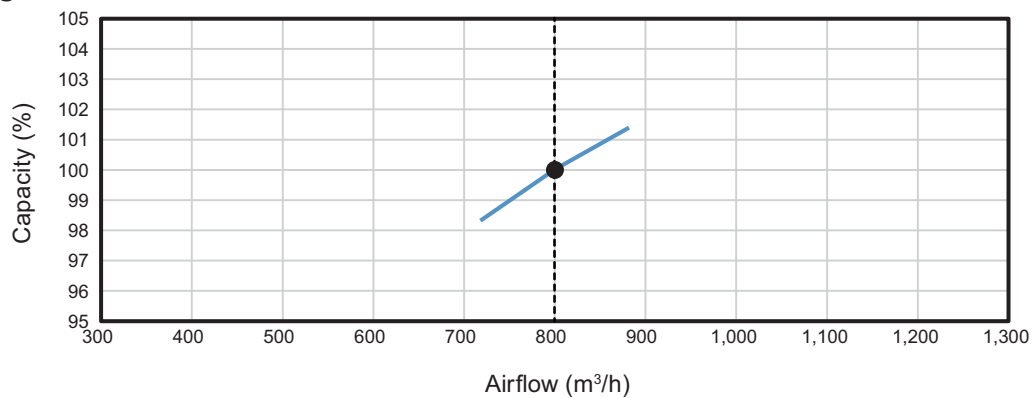

• Heating

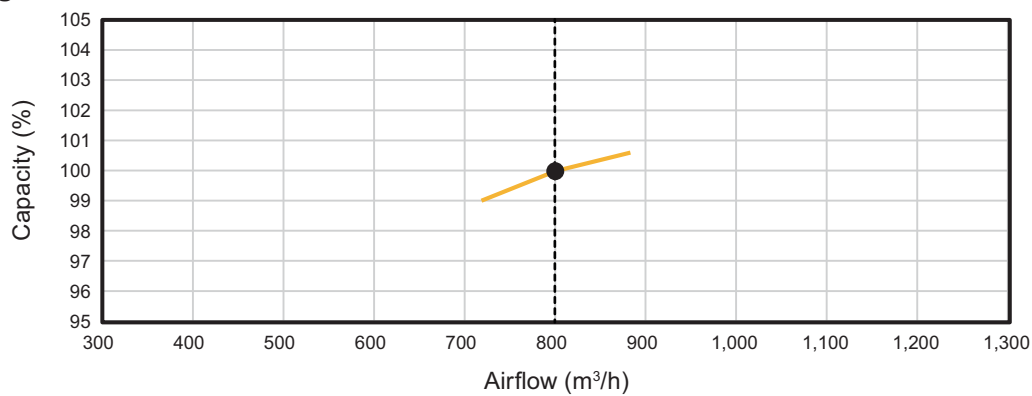

8. Airflow

Conversion factor:

- $1 \text{ m}^3/\text{h} = 0.2778 \text{ l/s} = 0.5886 \text{ CFM}$
- $3.6 \text{ m}^3/\text{h} = 1 \text{ l/s}$
- $1.699 \text{ m}^3/\text{h} = 1 \text{ CFM}$

8-1. Compact cassette type

Model	Operation mode	Fan speed	Airflow		
			m ³ /h	l/s	CFM
AUXG07KVLA AUXG09KVLA	Cooling	High	540	150	318
		Med	490	136	288
		Low	440	122	259
		Quiet	390	108	230
	Heating	High	540	150	318
		Med	490	136	288
		Low	440	122	259
		Quiet	390	108	230
AUXG12KVLA	Cooling	High	610	169	359
		Med	530	147	312
		Low	470	131	277
		Quiet	410	114	241
	Heating	High	610	169	359
		Med	530	147	312
		Low	470	131	277
		Quiet	410	114	241
AUXG14KVLA	Cooling	High	680	189	400
		Med	580	161	341
		Low	490	136	288
		Quiet	410	114	241
	Heating	High	790	219	465
		Med	680	189	400
		Low	580	161	341
		Quiet	450	125	265

8-2. Mini duct type

Model	Operation mode	Fan speed	Airflow		
			m ³ /h	l/s	CFM
ARXG07KSLAP	Cooling	High	550	153	324
		Med	440	122	259
		Low	390	108	230
		Quiet	360	100	212
	Heating	High	550	153	324
		Med	440	122	259
		Low	390	108	230
		Quiet	360	100	212
ARXG09KSLAP	Cooling	High	600	167	353
		Med	450	125	265
		Low	400	111	235
		Quiet	360	100	212
	Heating	High	600	167	353
		Med	450	125	265
		Low	400	111	235
		Quiet	360	100	212
ARXG12KSLAP	Cooling	High	650	181	383
		Med	490	136	288
		Low	430	119	253
		Quiet	360	100	212
	Heating	High	650	181	383
		Med	490	136	288
		Low	430	119	253
		Quiet	360	100	212
ARXG14KSLAP	Cooling	High	800	222	471
		Med	640	178	377
		Low	530	147	312
		Quiet	360	100	212
	Heating	High	800	222	471
		Med	640	178	377
		Low	530	147	312
		Quiet	360	100	212

8-3. Slim duct type

Model	Operation mode	Fan speed	Airflow		
			m ³ /h	l/s	CFM
ARXG07KLLAP	Cooling	High	550	153	324
		Med	490	136	288
		Low	470	131	277
		Quiet	440	122	259
	Heating	High	550	153	324
		Med	490	136	288
		Low	470	131	277
		Quiet	440	122	259
ARXG09KLLAP	Cooling	High	600	167	353
		Med	550	153	324
		Low	500	139	294
		Quiet	450	125	265
	Heating	High	600	167	353
		Med	550	153	324
		Low	500	139	294
		Quiet	450	125	265
ARXG12KLLAP	Cooling	High	650	181	383
		Med	600	167	353
		Low	550	153	324
		Quiet	480	133	283
	Heating	High	650	181	383
		Med	600	167	353
		Low	550	153	324
		Quiet	480	133	283
ARXG14KLLAP	Cooling	High	800	222	471
		Med	700	194	412
		Low	600	167	353
		Quiet	480	133	283
	Heating	High	800	222	471
		Med	700	194	412
		Low	600	167	353
		Quiet	480	133	283

8-4. Medium static pressure duct type

Model	Operation mode	Fan speed	Airflow		
			m ³ /h	l/s	CFM
ARXH12KMTAP	Cooling	High	650	181	383
		Med	520	144	306
		Low	460	128	271
		Quiet	390	108	230
	Heating	High	650	181	383
		Med	520	144	306
		Low	460	128	271
		Quiet	390	108	230
ARXH14KMTAP	Cooling	High	800	222	471
		Med	640	178	377
		Low	560	156	330
		Quiet	480	133	283
	Heating	High	800	222	471
		Med	640	178	377
		Low	560	156	330
		Quiet	480	133	283

8-5. Wall mounted type

Model	Operation mode	Fan speed	Airflow		
			m ³ /h	l/s	CFM
ASEH07KMCG ASEH07KMCG-B	Cooling	High	650	181	383
		Med	540	150	318
		Low	430	119	253
		Quiet	320	89	188
	Heating	High	720	200	424
		Med	580	161	341
		Low	460	128	271
		Quiet	330	92	194
ASEH09KMCG ASEH09KMCG-B	Cooling	High	700	194	412
		Med	560	156	330
		Low	430	119	253
		Quiet	320	89	188
	Heating	High	750	208	441
		Med	610	169	359
		Low	470	131	277
		Quiet	330	92	194
ASEH12KMCG ASEH12KMCG-B	Cooling	High	700	194	412
		Med	560	156	330
		Low	430	119	253
		Quiet	320	89	188
	Heating	High	780	217	459
		Med	640	178	377
		Low	520	144	306
		Quiet	330	92	194
ASEH14KMCG ASEH14KMCG-B	Cooling	High	770	214	453
		Med	600	167	353
		Low	450	125	265
		Quiet	310	86	182
	Heating	High	820	228	483
		Med	660	183	388
		Low	520	144	306
		Quiet	340	94	200
ASEG07KETF ASEG07KETF-B	Cooling	High	650	181	383
		Med	540	150	318
		Low	430	119	253
		Quiet	270	75	159
	Heating	High	720	200	424
		Med	580	161	341
		Low	460	128	271
		Quiet	330	92	194
ASEG09KETF ASEG09KETF-B	Cooling	High	700	194	412
		Med	560	156	330
		Low	430	119	253
		Quiet	270	75	159
	Heating	High	750	208	441
		Med	610	169	359
		Low	470	131	277
		Quiet	330	92	194

Model	Operation mode	Fan speed	Airflow		
			m ³ /h	l/s	CFM
ASEG12KETF ASEG12KETF-B	Cooling	High	700	194	412
		Med	560	156	330
		Low	430	119	253
		Quiet	270	75	159
	Heating	High	770	214	453
		Med	640	178	377
		Low	520	144	306
		Quiet	330	92	194
ASEG14KETF ASEG14KETF-B	Cooling	High	770	214	453
		Med	600	167	353
		Low	450	125	265
		Quiet	280	78	165
	Heating	High	800	222	471
		Med	660	183	388
		Low	520	144	306
		Quiet	340	94	200
ASEH07KGTG	Cooling	High	650	181	383
		Med	540	150	318
		Low	430	119	253
		Quiet	270	75	159
	Heating	High	720	200	424
		Med	580	161	341
		Low	460	128	271
		Quiet	330	92	194
ASEH09KGTG	Cooling	High	700	194	412
		Med	560	156	330
		Low	430	119	253
		Quiet	270	75	159
	Heating	High	750	208	441
		Med	610	169	359
		Low	470	131	277
		Quiet	330	92	194
ASEH12KGTG	Cooling	High	700	194	412
		Med	560	156	330
		Low	430	119	253
		Quiet	270	75	159
	Heating	High	770	214	453
		Med	640	178	377
		Low	520	144	306
		Quiet	330	92	194
ASEH14KGTG	Cooling	High	770	214	453
		Med	600	167	353
		Low	450	125	265
		Quiet	280	78	165
	Heating	High	800	222	471
		Med	660	183	388
		Low	520	144	306
		Quiet	340	94	200

Model	Operation mode	Fan speed	Airflow		
			m ³ /h	l/s	CFM
ASEH05KNCA	Cooling	High	500	139	294
		Med	450	125	265
		Low	390	108	230
		Quiet	250	69	147
	Heating	High	500	139	294
		Med	450	125	265
		Low	420	117	247
		Quiet	280	78	165
ASEH07KNCA	Cooling	High	530	147	312
		Med	460	128	271
		Low	390	108	230
		Quiet	250	69	147
	Heating	High	530	147	312
		Med	460	128	271
		Low	420	117	247
		Quiet	280	78	165
ASEH09KNCA	Cooling	High	640	178	377
		Med	500	139	294
		Low	390	108	230
		Quiet	250	69	147
	Heating	High	640	178	377
		Med	500	139	294
		Low	420	117	247
		Quiet	280	78	165
ASEH12KNCA	Cooling	High	660	183	388
		Med	520	144	306
		Low	440	122	259
		Quiet	250	69	147
	Heating	High	660	183	388
		Med	520	144	306
		Low	440	122	259
		Quiet	280	78	165

8-6. Floor type

Model	Operation mode	Fan speed	Airflow		
			m ³ /h	l/s	CFM
AGEG09KVCA	Cooling	High	530	147	312
		Med	440	111	235
		Low	360	100	212
		Quiet	270	75	159
	Heating	High	530	147	312
		Med	460	128	271
		Low	380	106	224
		Quiet	270	75	159
AGEG12KVCA	Cooling	High	600	167	353
		Med	490	136	288
		Low	380	106	224
		Quiet	270	75	159
	Heating	High	600	167	353
		Med	510	142	300
		Low	410	114	241
		Quiet	270	75	159
AGEG14KVCA	Cooling	High	650	181	383
		Med	520	144	306
		Low	400	131	277
		Quiet	270	75	159
	Heating	High	650	181	383
		Med	540	150	318
		Low	430	119	253
		Quiet	270	75	159

9. Noise level curve

9-1. Compact cassette type

Model: AUXG07KVLA

Cooling

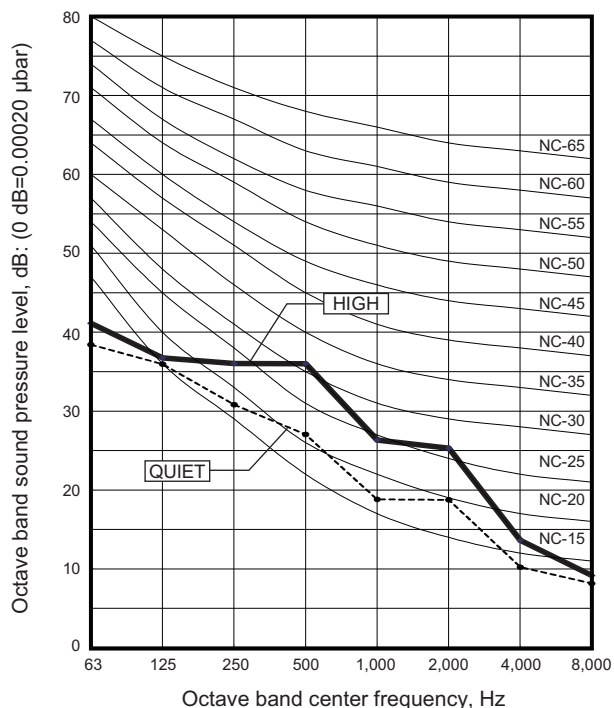

Heating

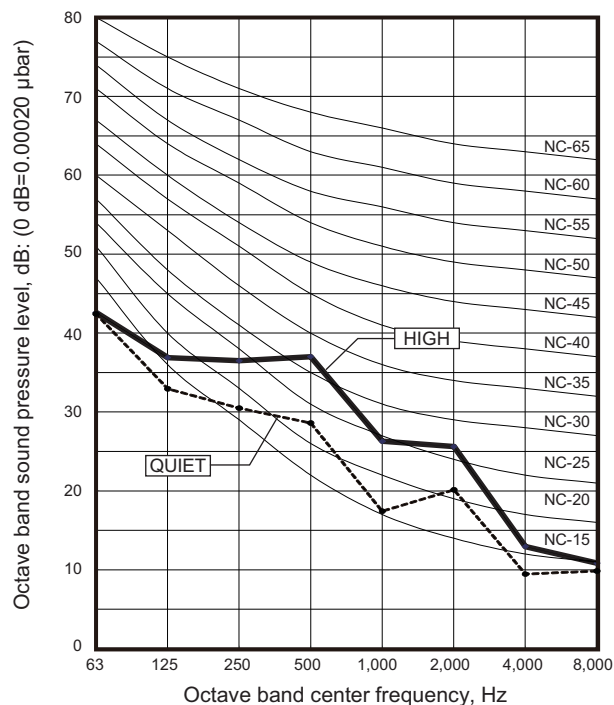

Model: AUXG09KVLA

Cooling

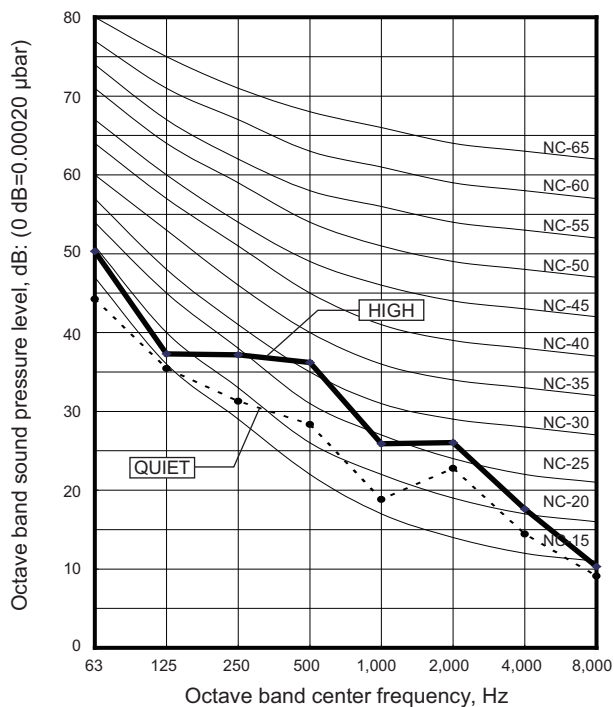

Heating

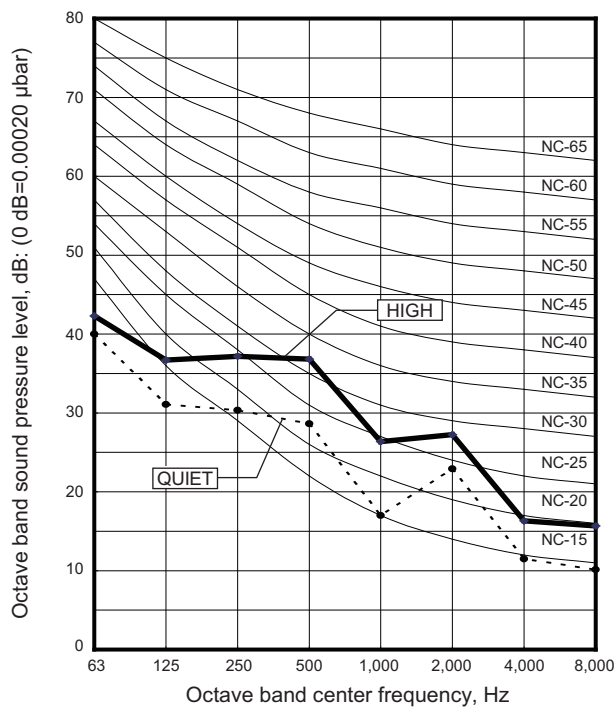

Model: AUXG12KVLA

Cooling

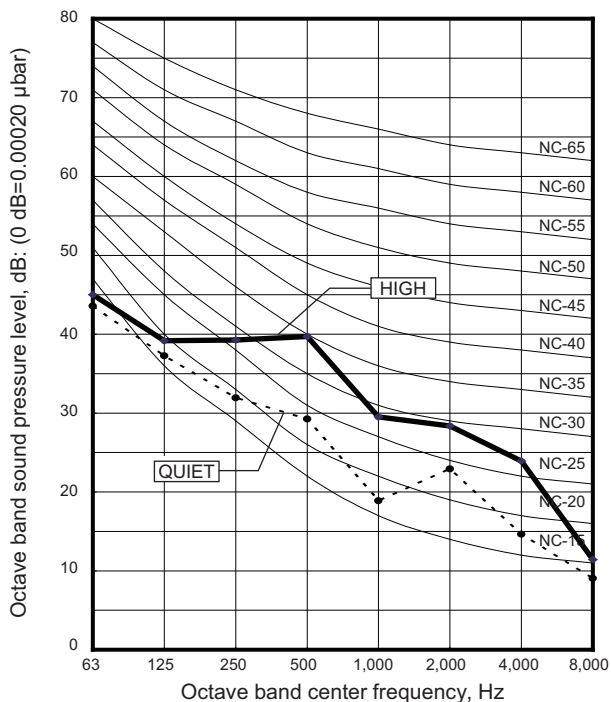

Heating

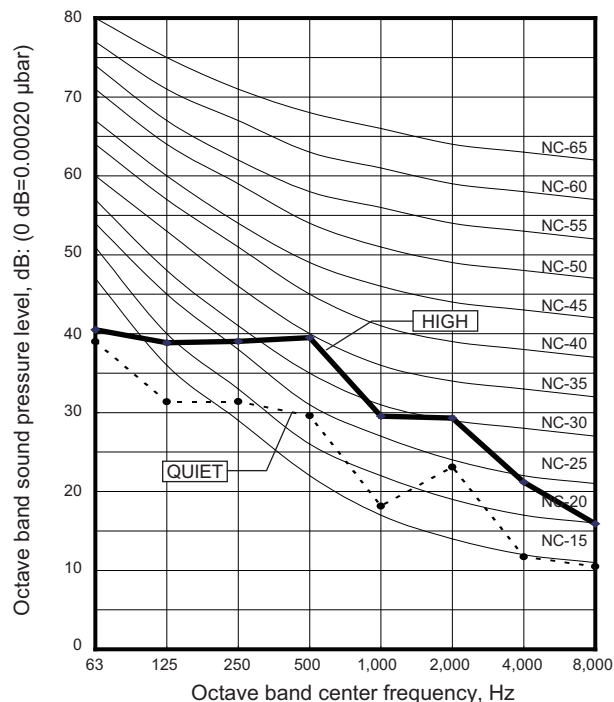

Model: AUXG14KVLA

Cooling

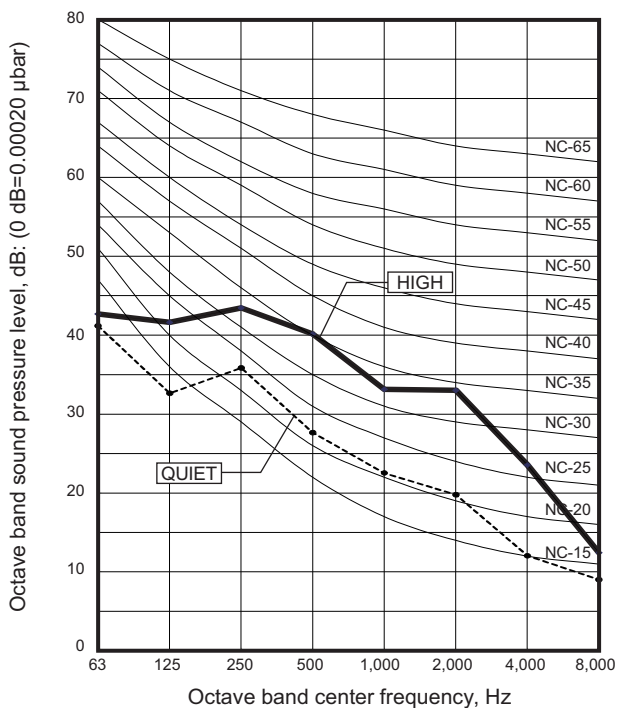

Heating

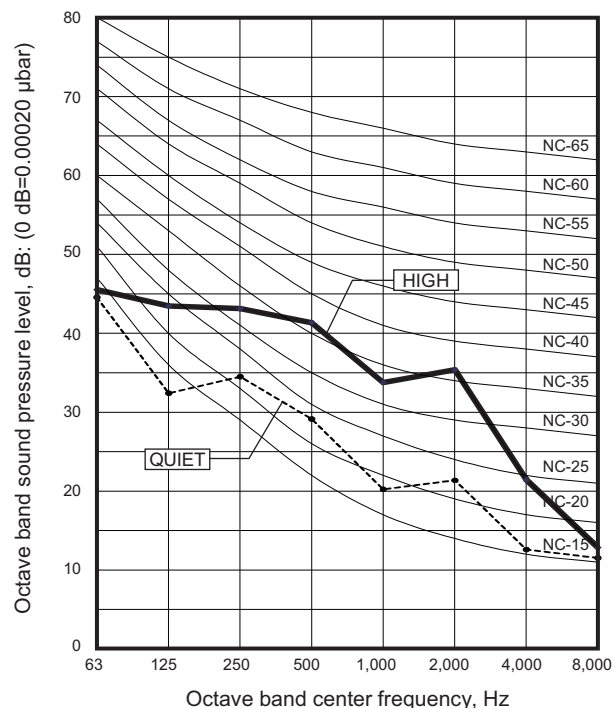

9-2. Mini duct type

Model: ARXG07KSLAP

● Cooling

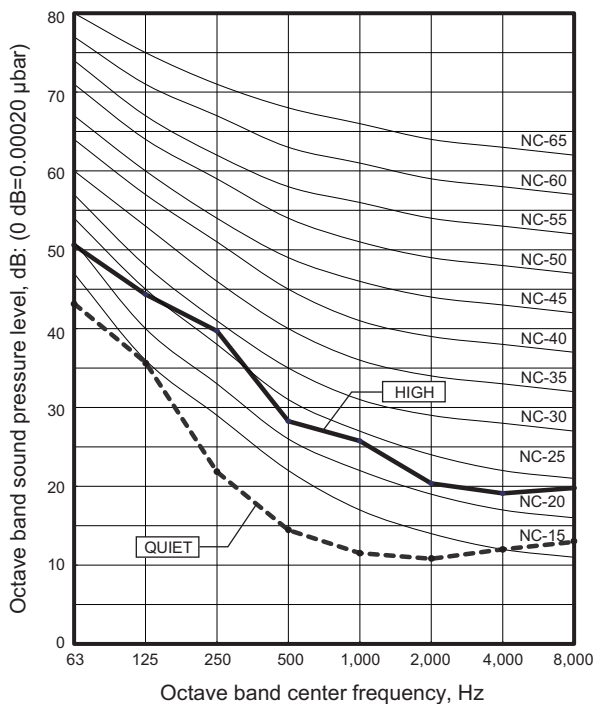

● Heating

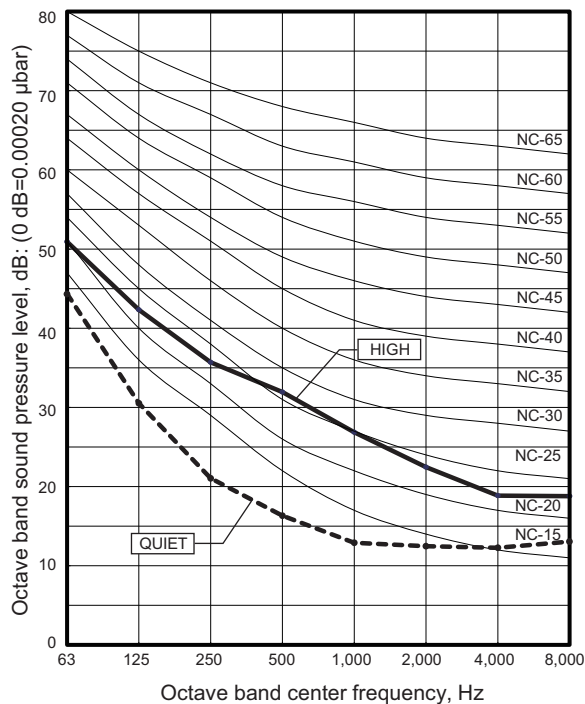

Model: ARXG09KSLAP

● Cooling

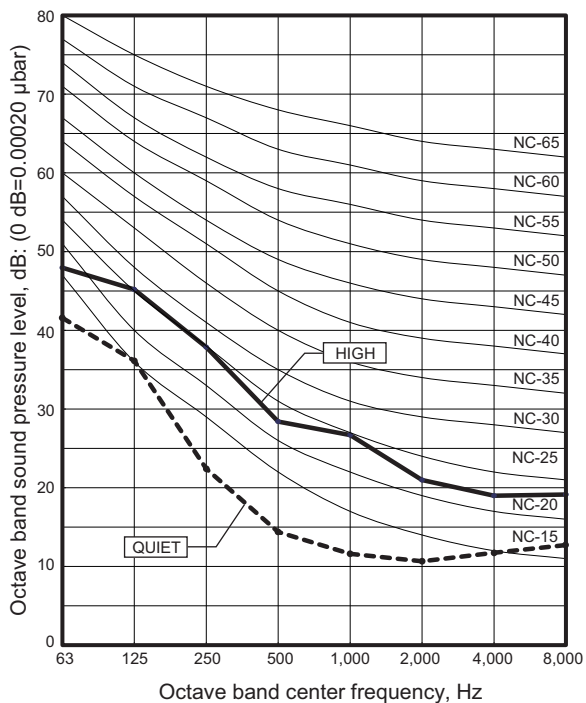

● Heating

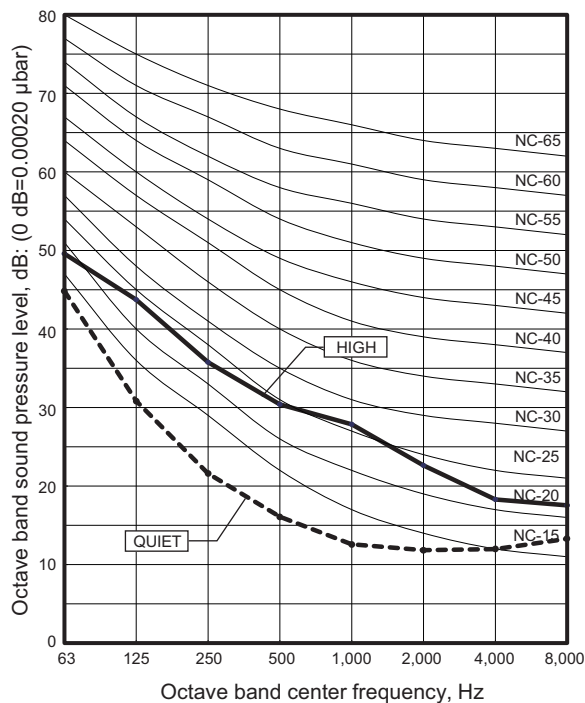

Model: ARXG12KSLAP

Cooling

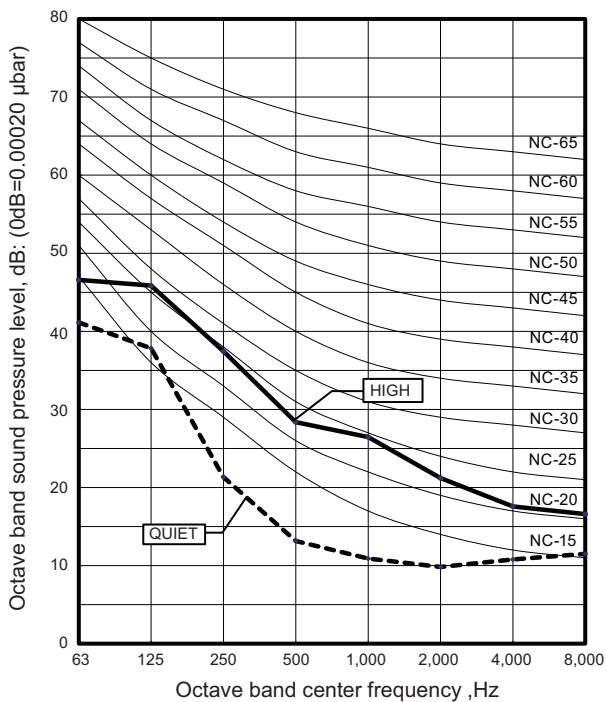

Heating

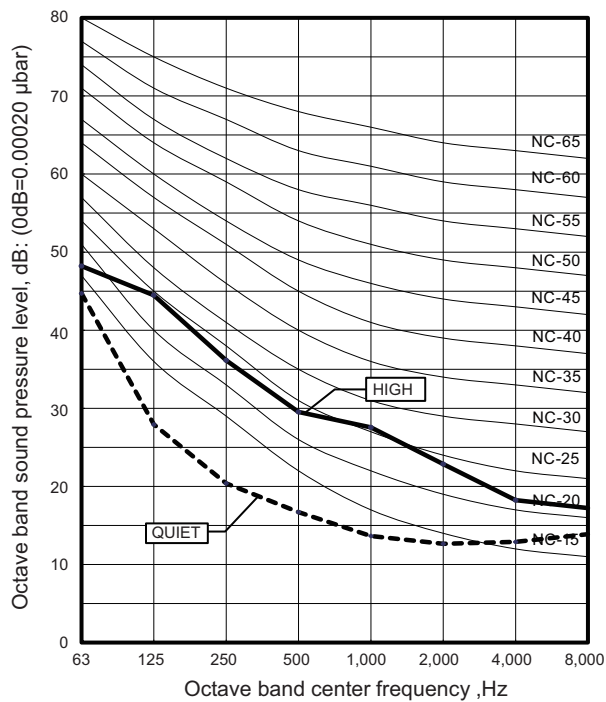

Model: ARXG14KSLAP

Cooling

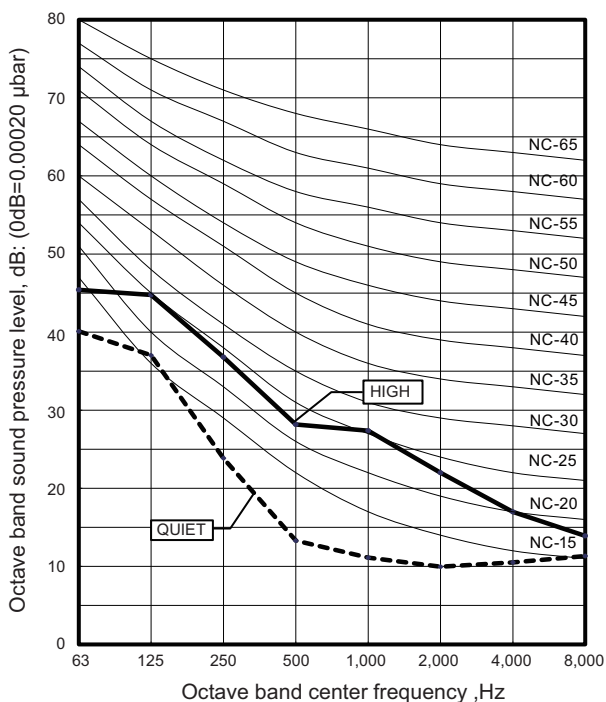

Heating

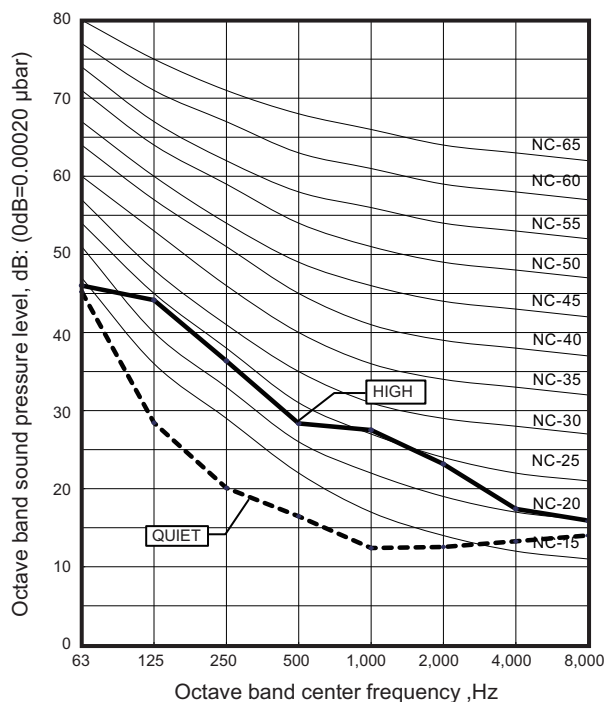

9-3. Slim duct type

Model: ARXG07KLLAP

● Cooling

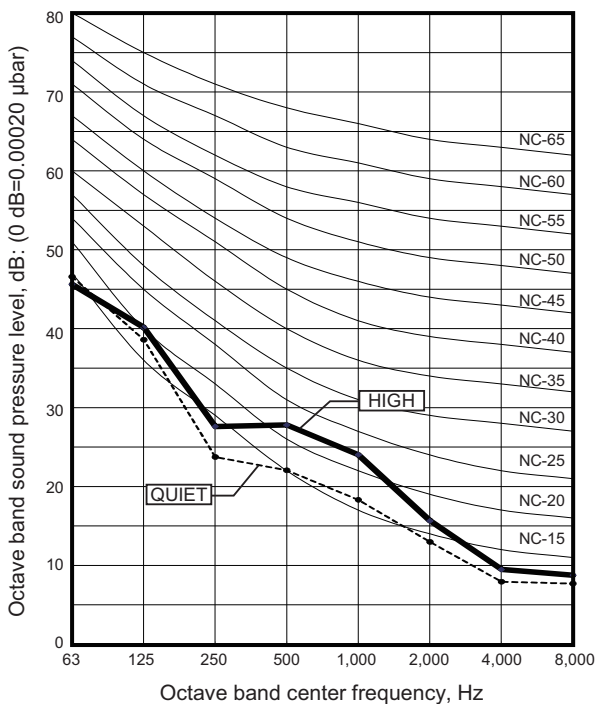

● Heating

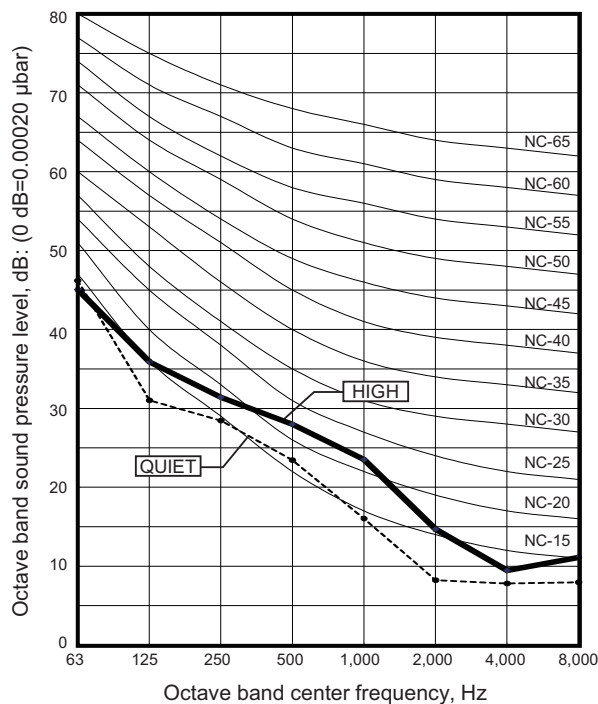

Model: ARXG09KLLAP

● Cooling

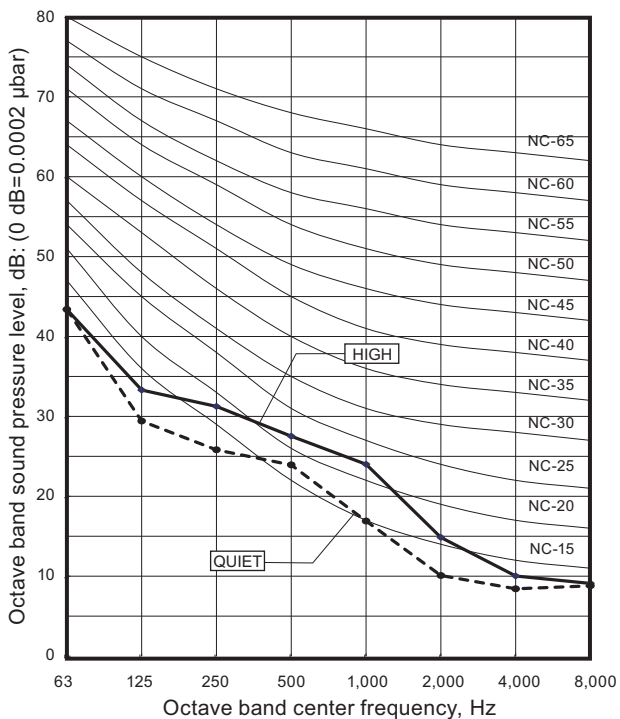

● Heating

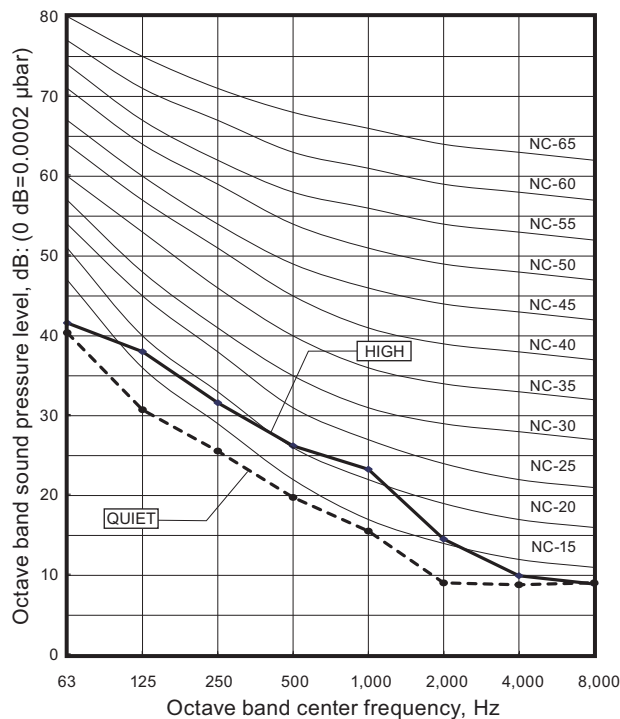

Model: ARXG12KLLAP

Cooling

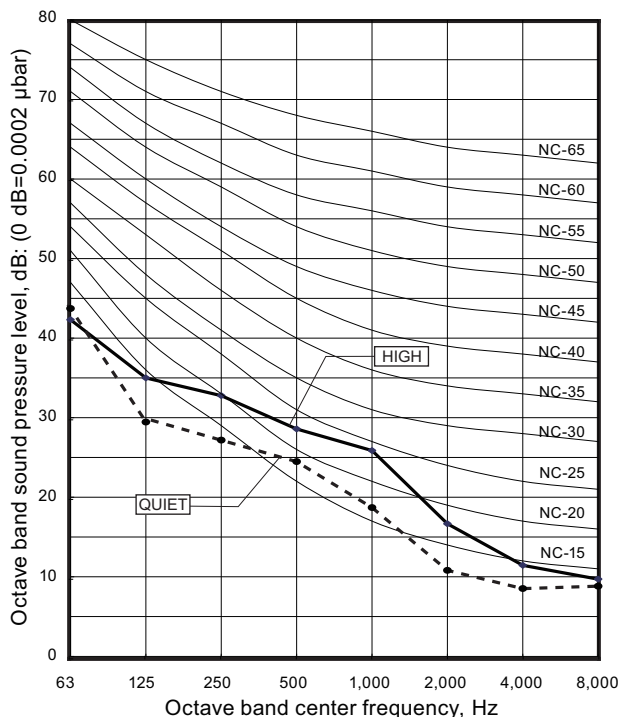

Heating

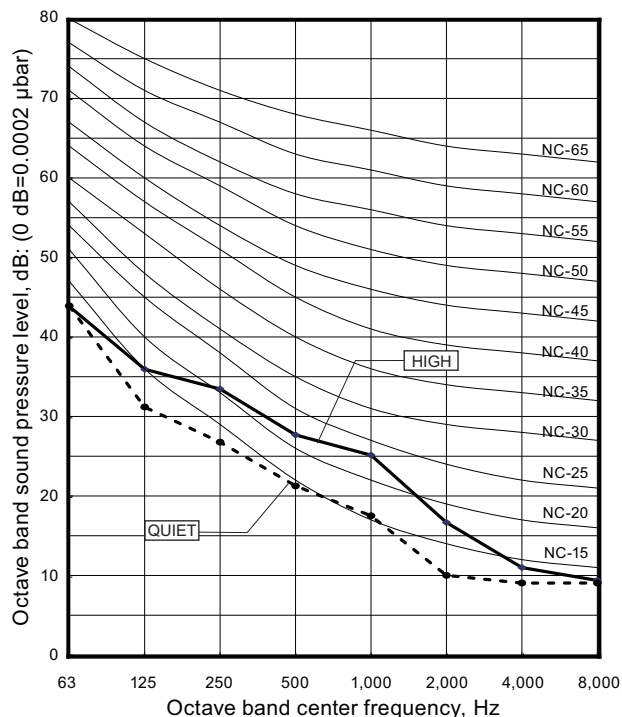

Model: ARXG14KLLAP

Cooling

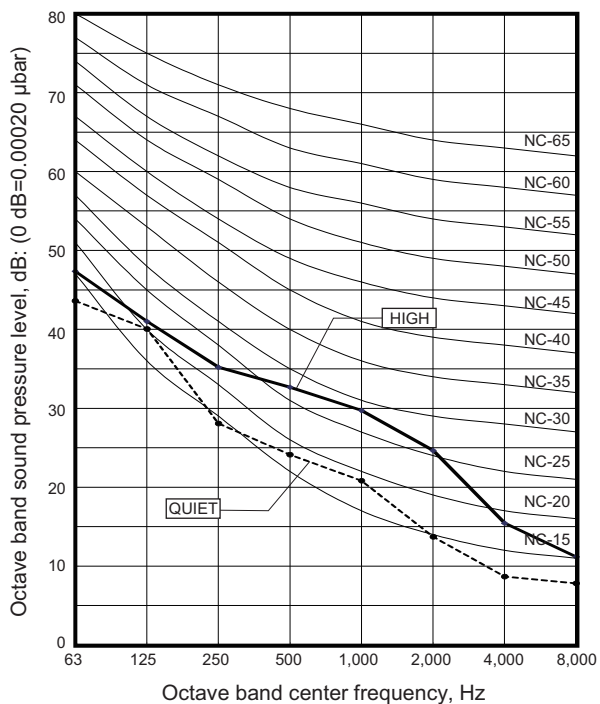

Heating

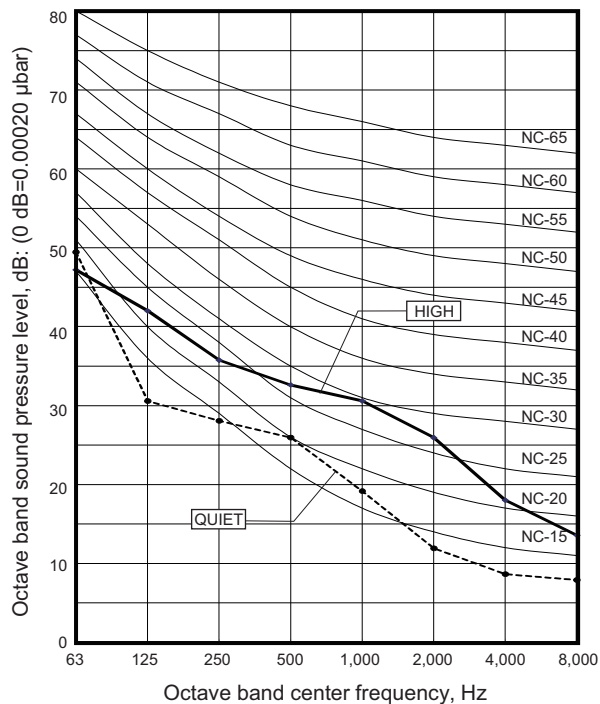

9-4. Medium static pressure duct type

Model: ARXH12KMTAP

Cooling

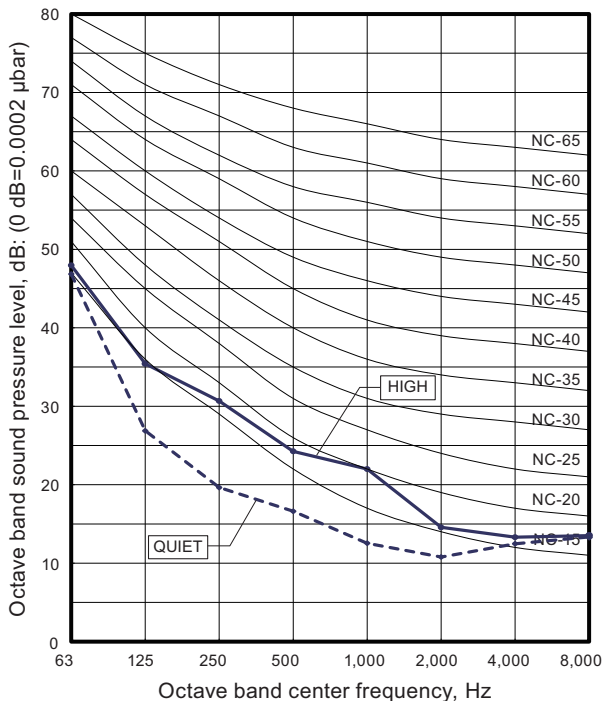

Heating

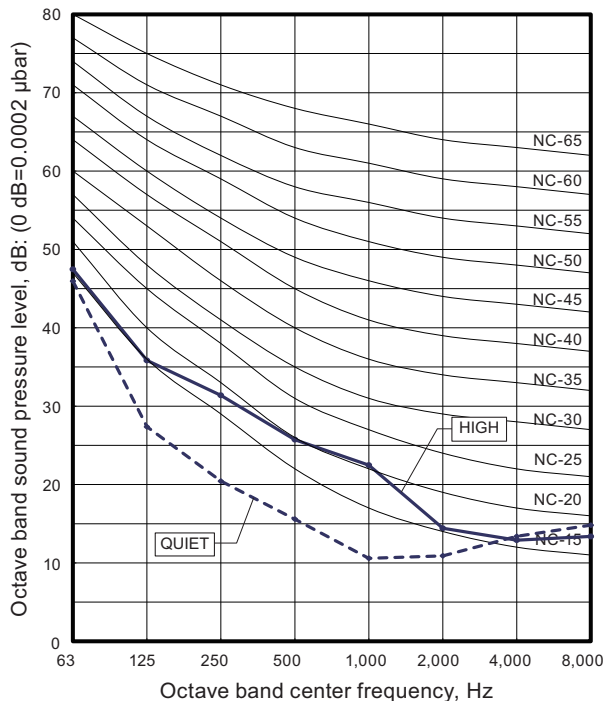

Model: ARXH14KMTAP

Cooling

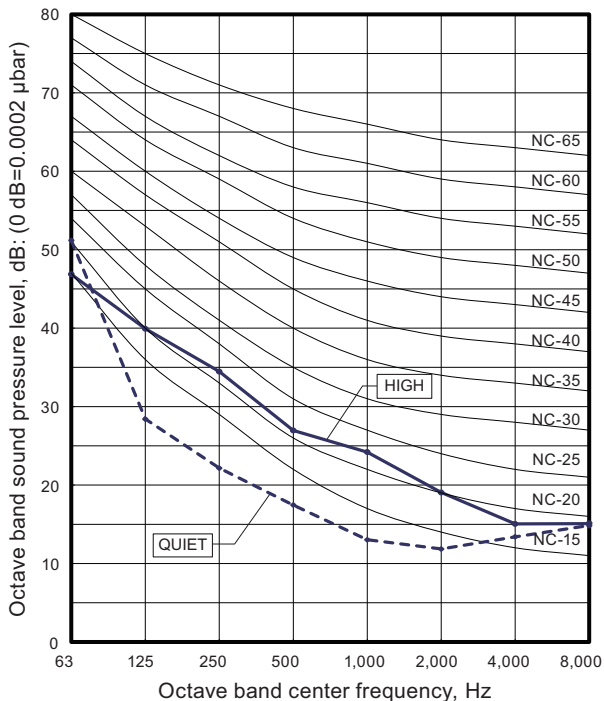

Heating

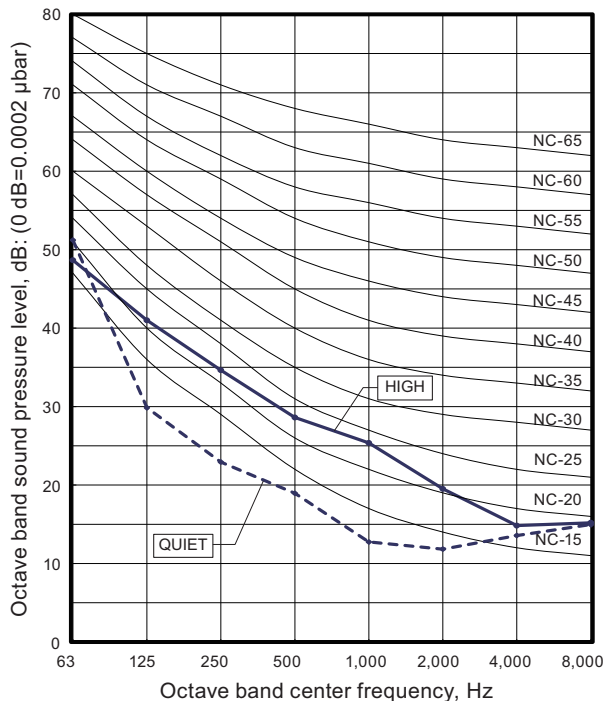

9-5. Wall mounted type

■ Models: ASEH07KMCG, ASEH07KMCG-B, ASEG07KETF, and ASEG07KETF-B

● Cooling

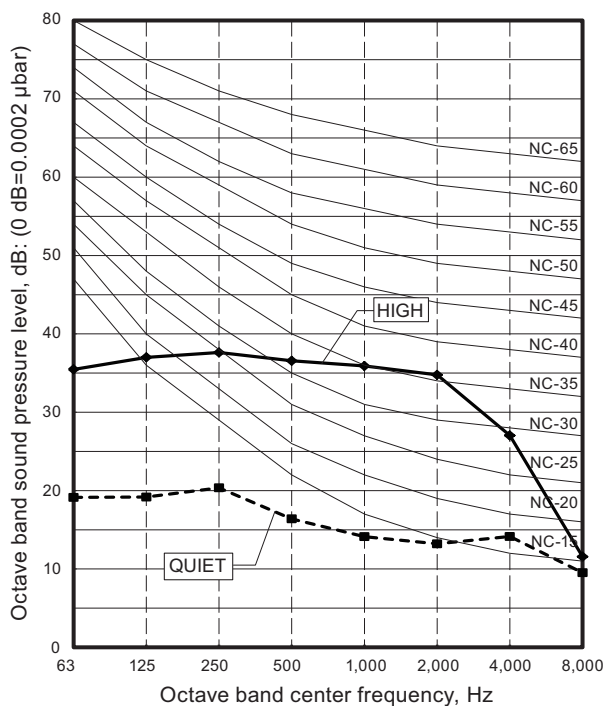

● Heating

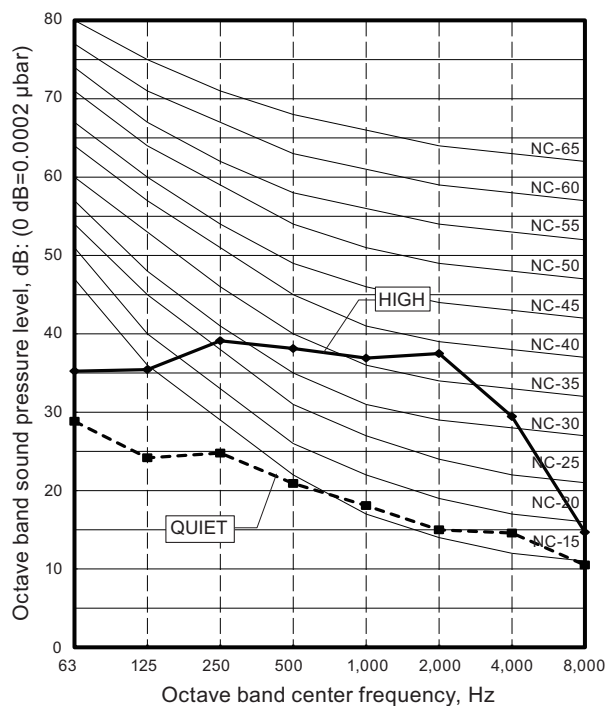

■ Models: ASEH09KMCG, ASEH09KMCG-B, ASEG09KETF, and ASEG09KETF-B

● Cooling

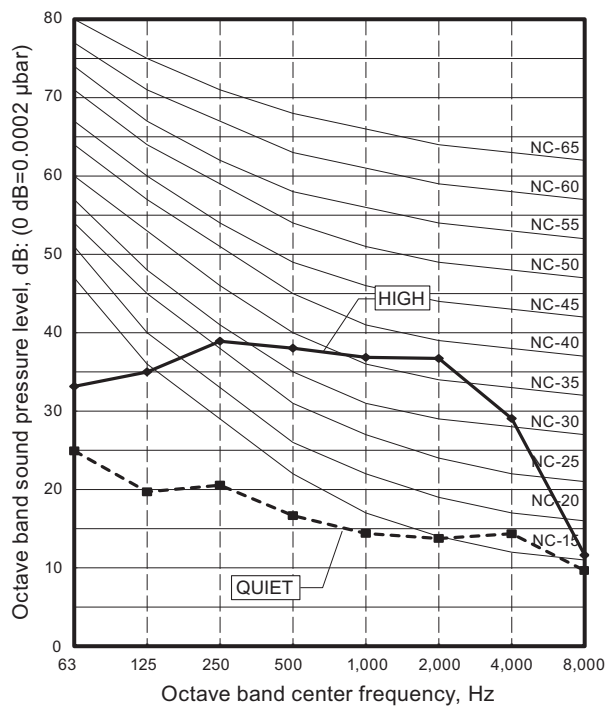

● Heating

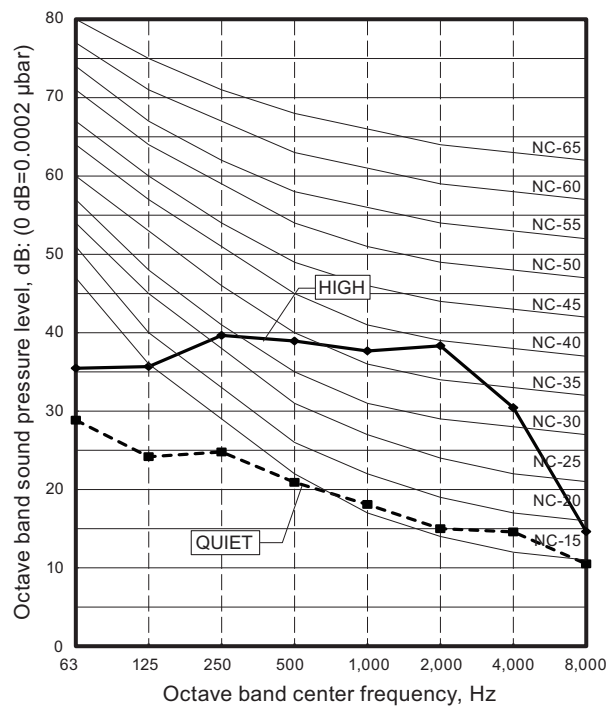

■ Models: ASEH12KMCG, ASEH12KMCG-B, ASEG12KETF, and ASEG12KETF-B

● Cooling

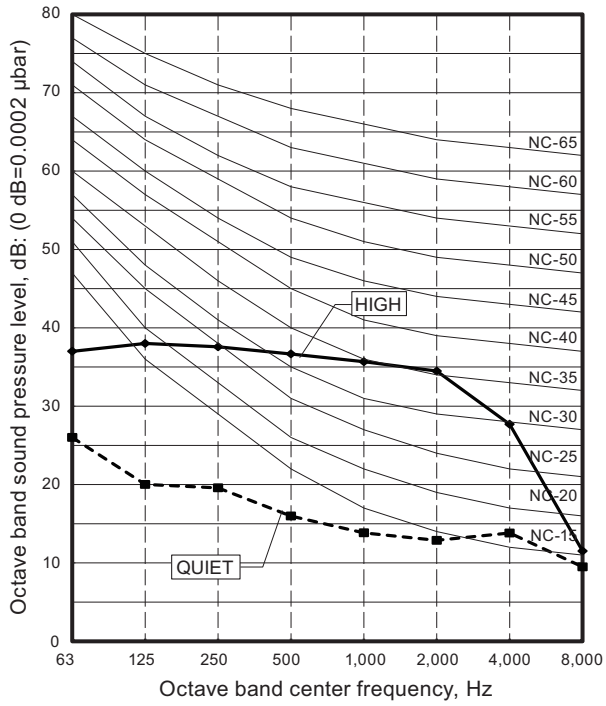

● Heating

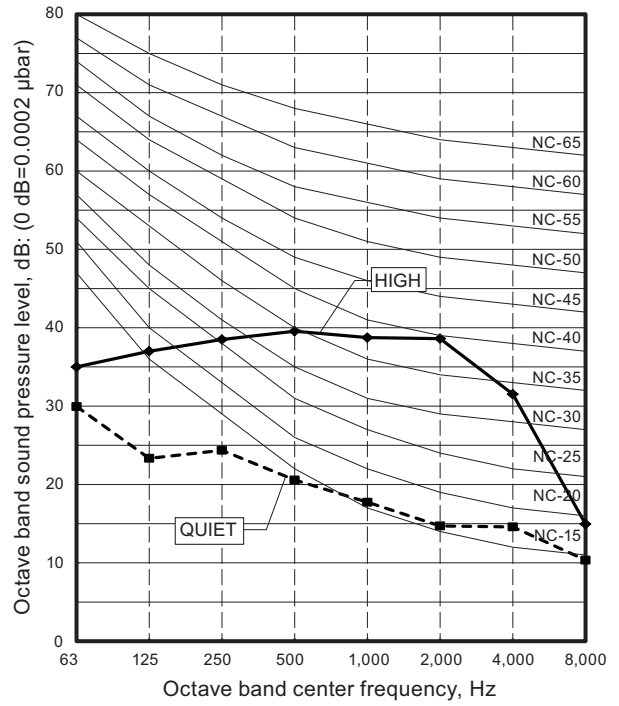

■ Models: ASEH14KMCG, ASEH14KMCG-B, ASEG14KETF, and ASEG14KETF-B

● Cooling

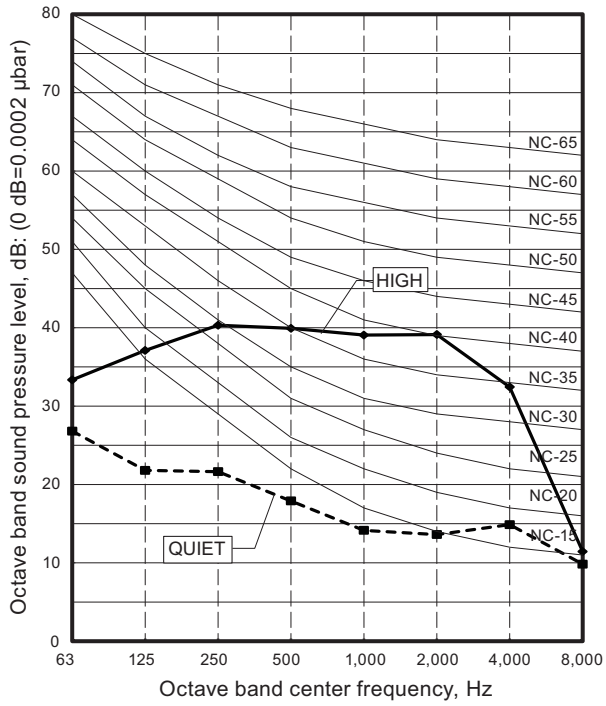

● Heating

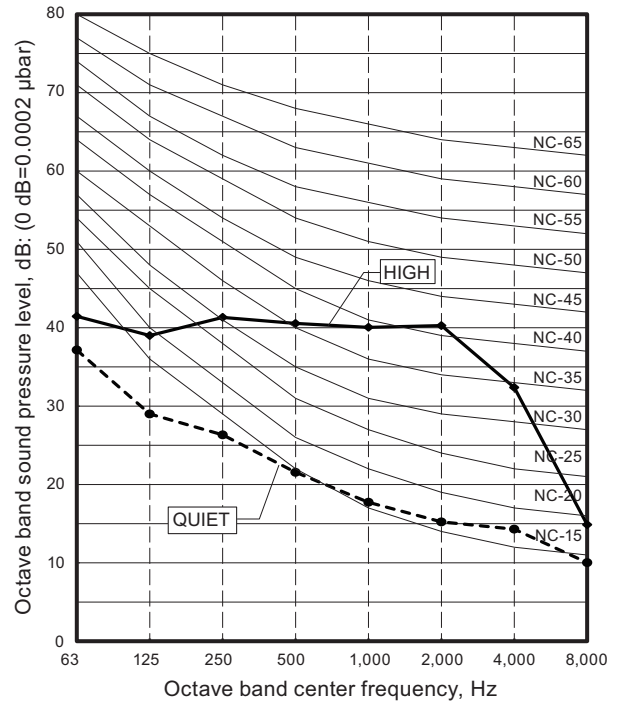

Model: ASEH07KGTG

Cooling

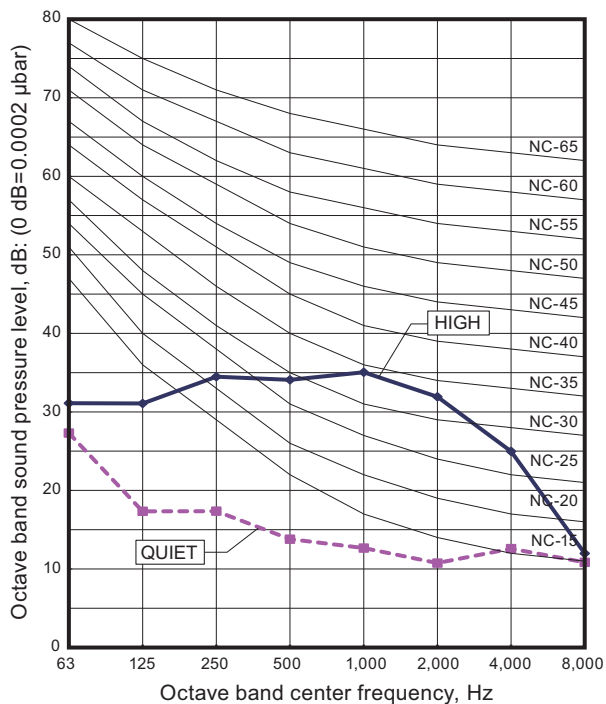

Heating

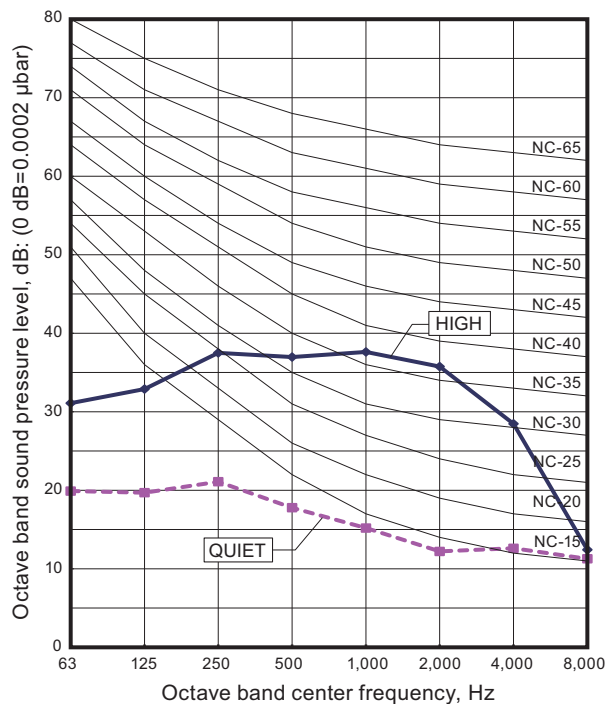

Model: ASEH09KGTG

Cooling

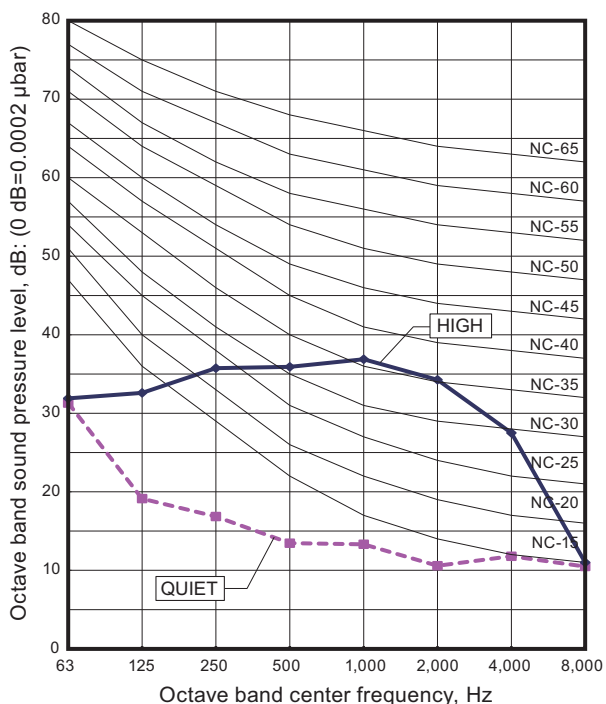

Heating

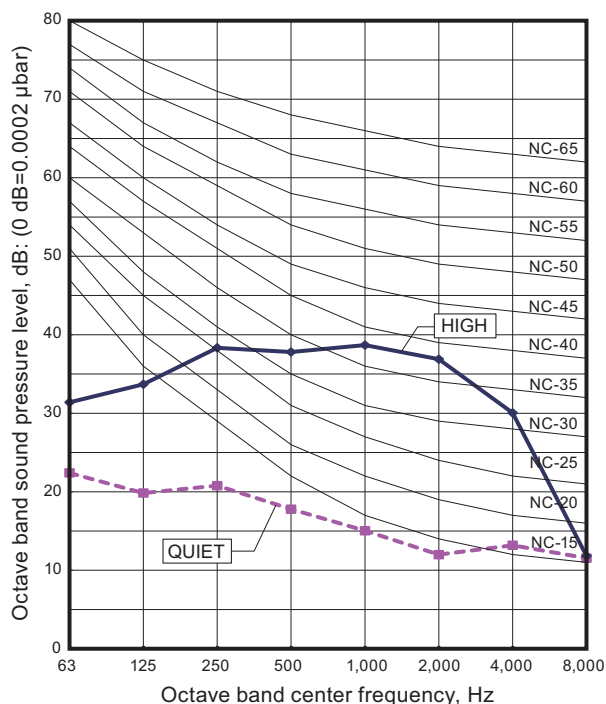

Model: ASEH12KGTG

Cooling

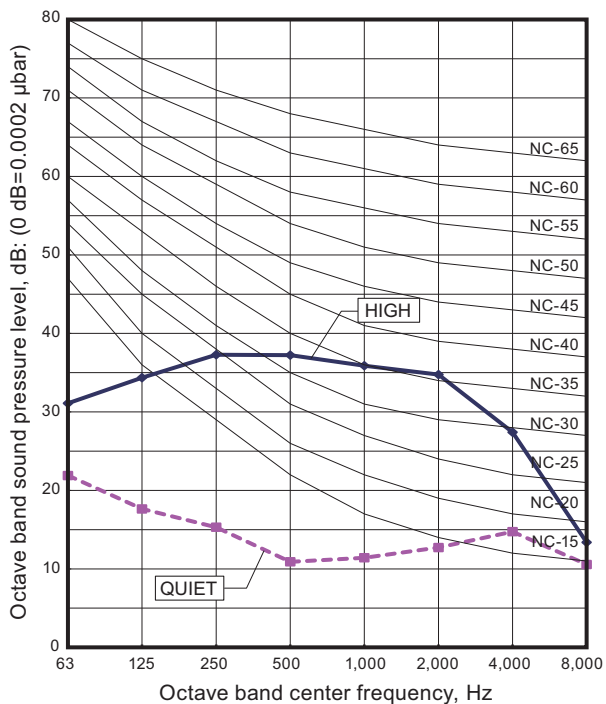

Heating

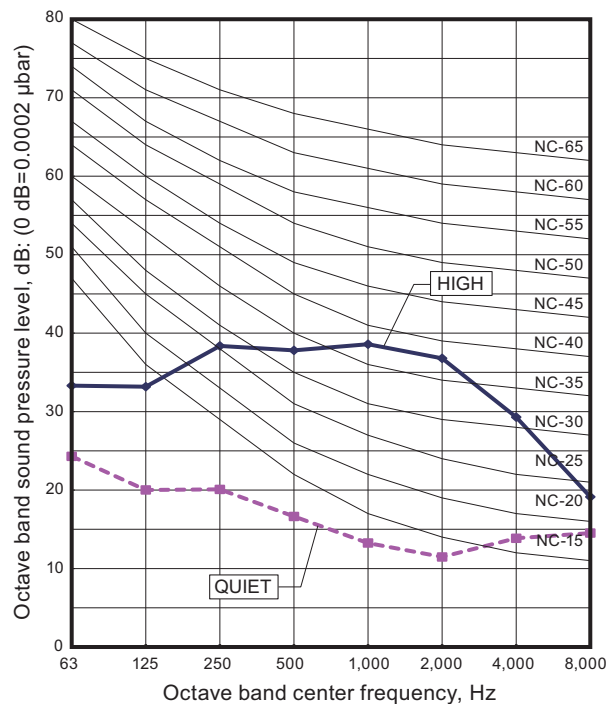

Model: ASEH14KGTG

Cooling

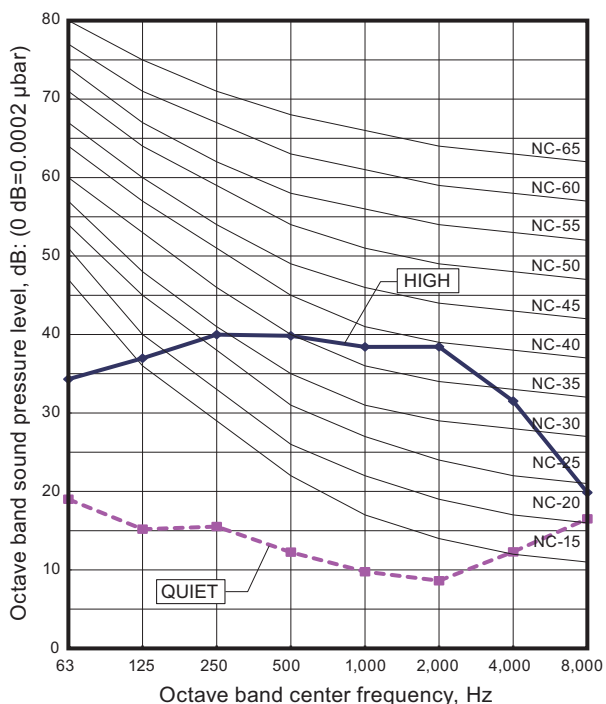

Heating

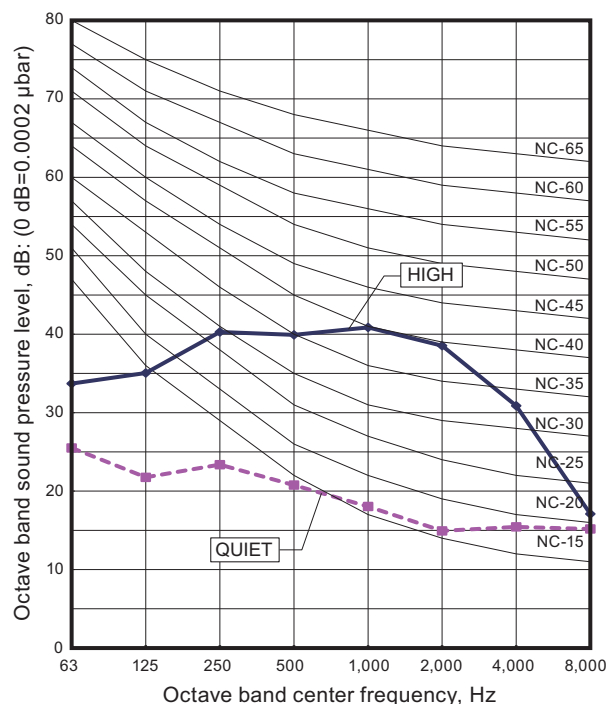

ASEH05KNCA

Cooling

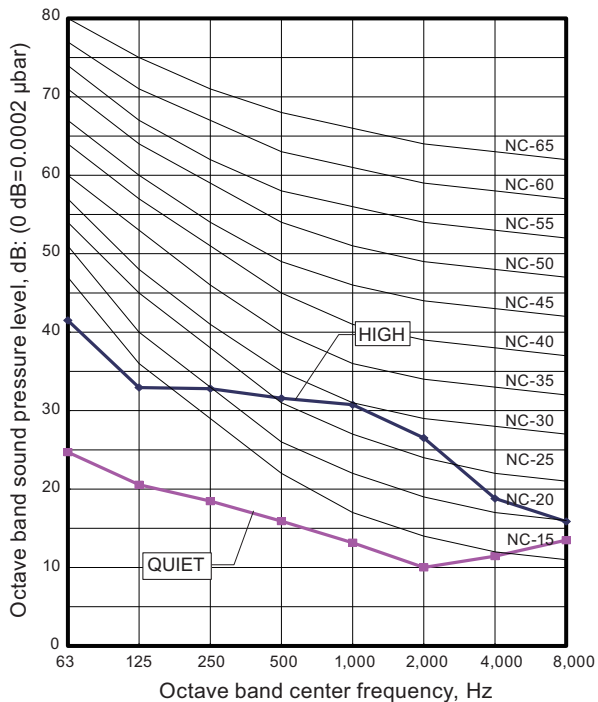

Heating

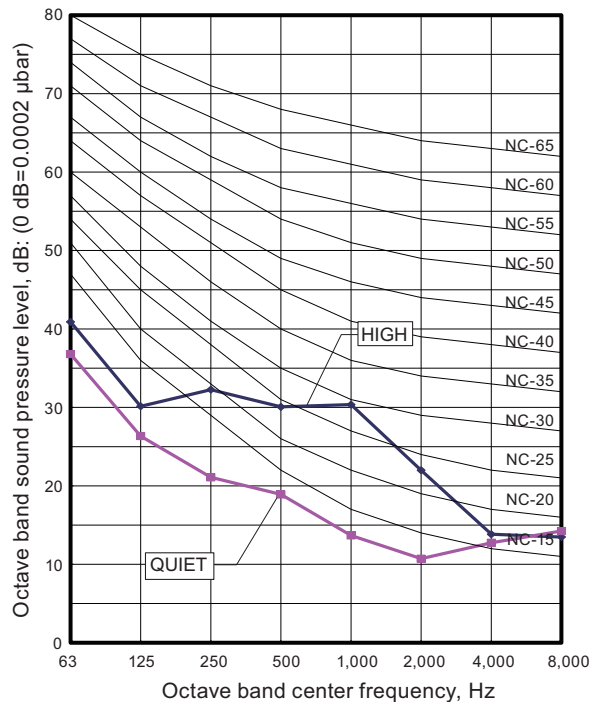

ASEH07KNCA

Cooling

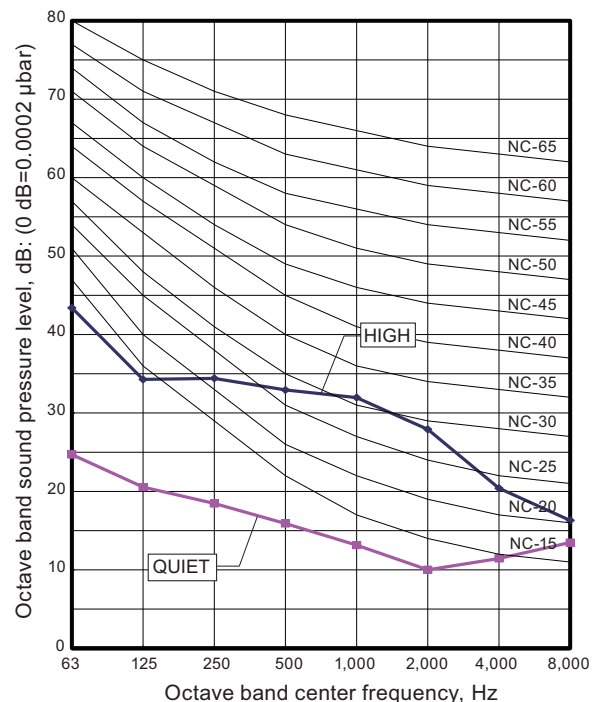

Heating

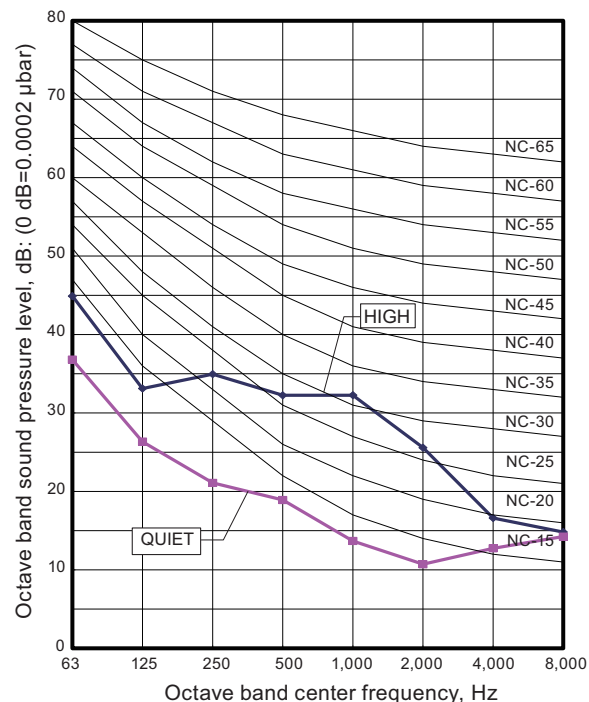

ASEH09KNCA

Cooling

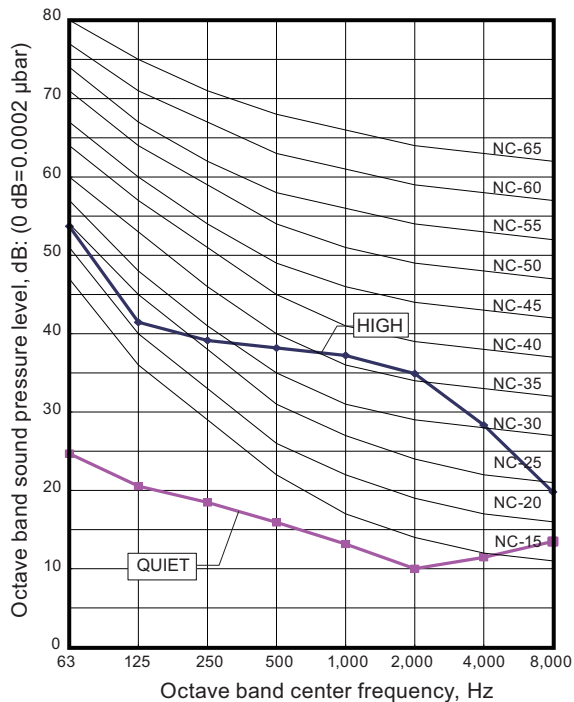

Heating

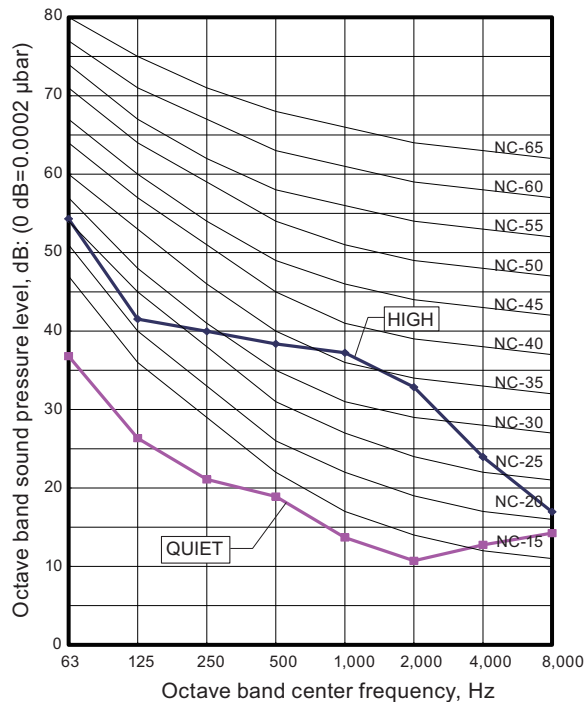

ASEH12KNCA

Cooling

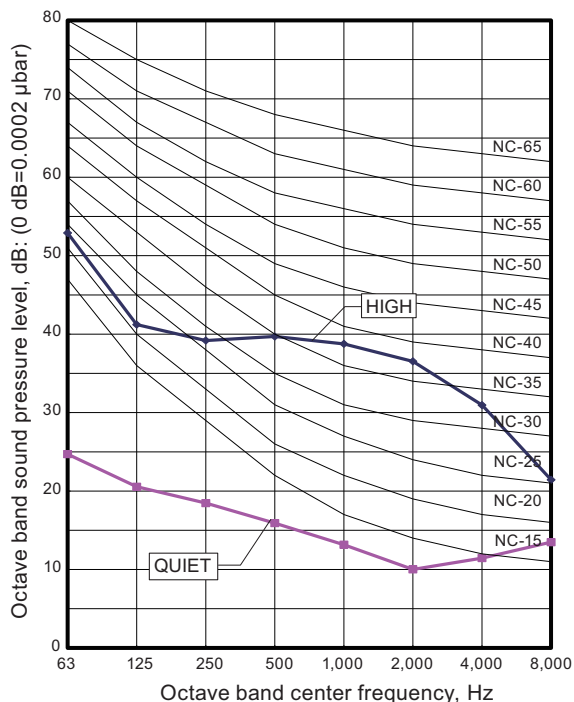

Heating

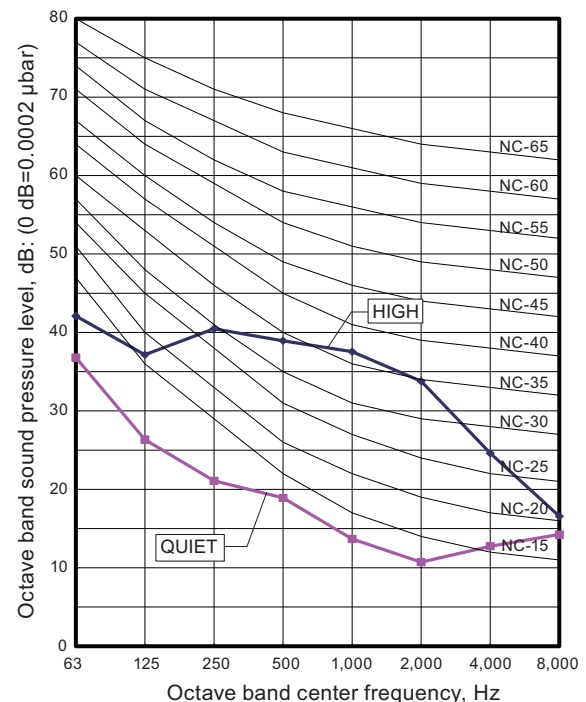

9-6. Floor type

Model: AGE09KVCA

Cooling

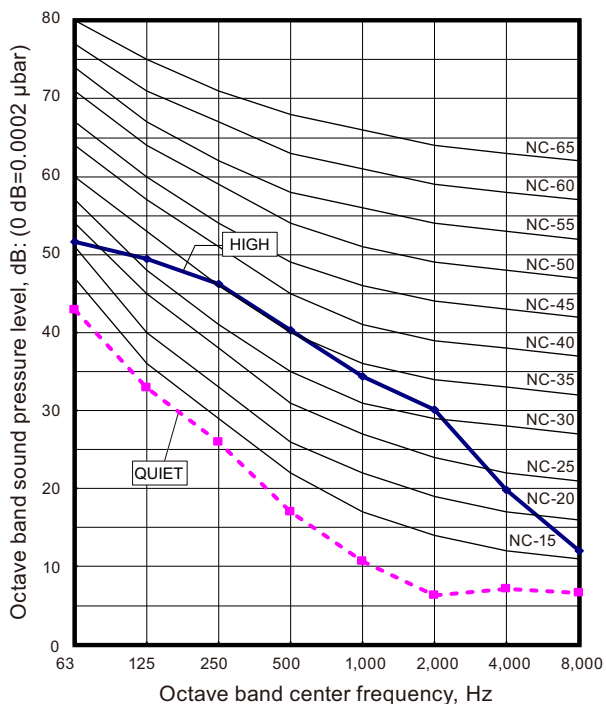

Heating

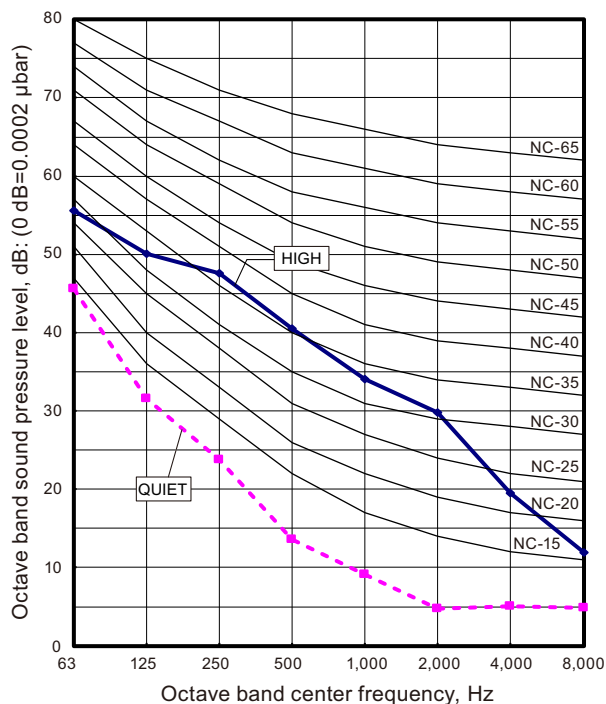

Model: AGE12KVCA

Cooling

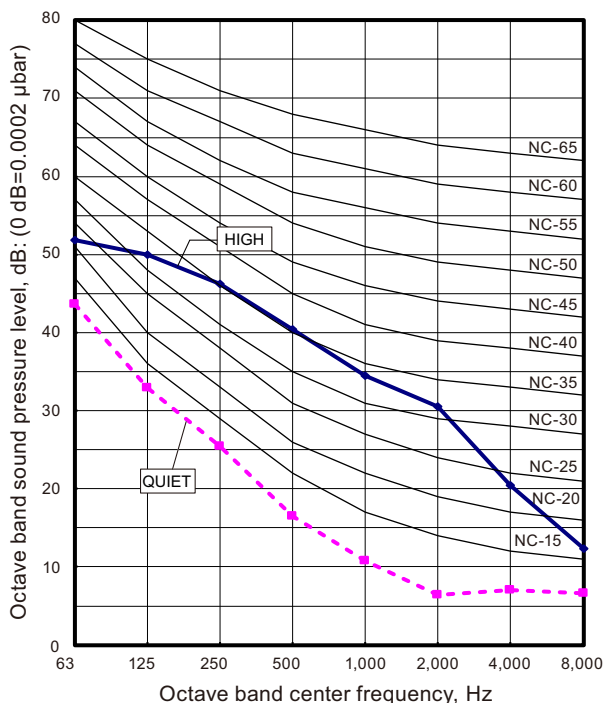

Heating

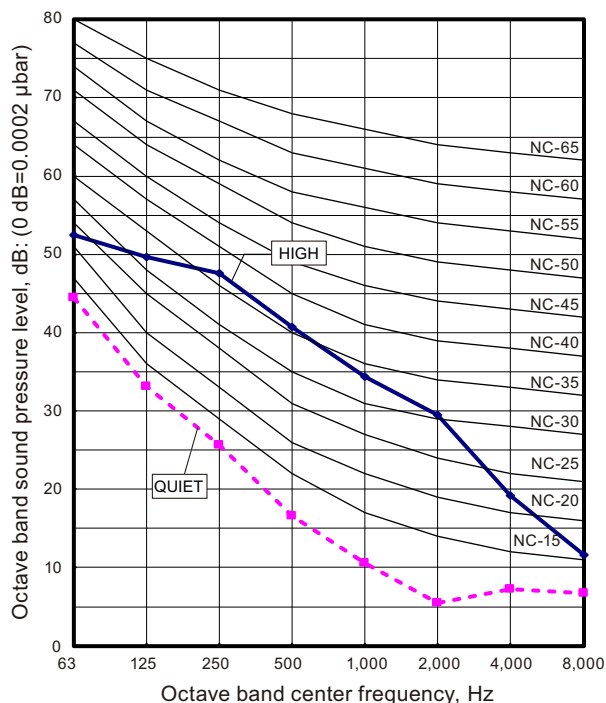

Model: AGE14KVCA

● Cooling

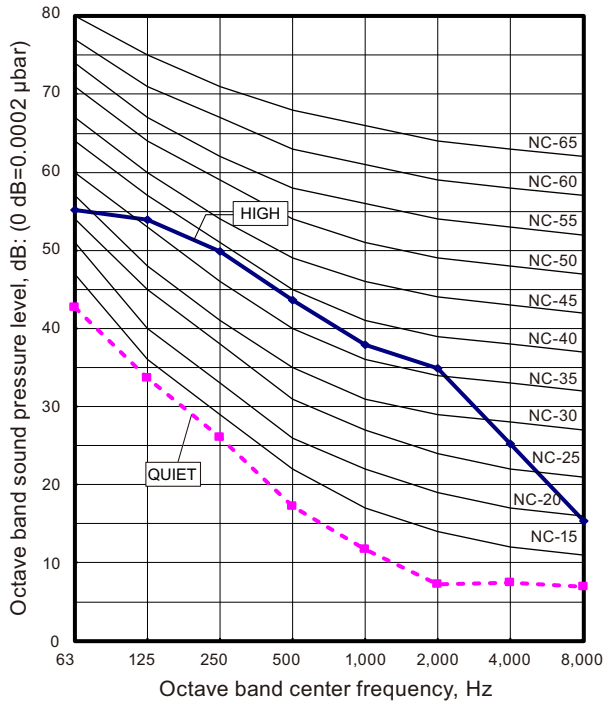

● Heating

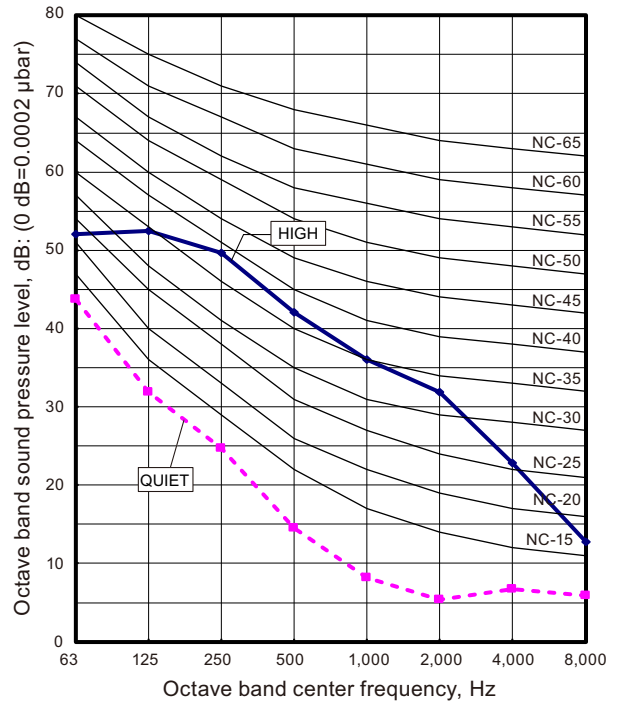

9-7. Sound level check point

■ Compact cassette type

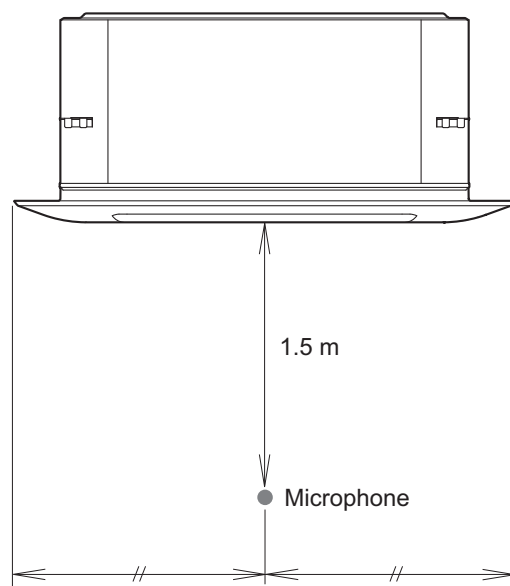
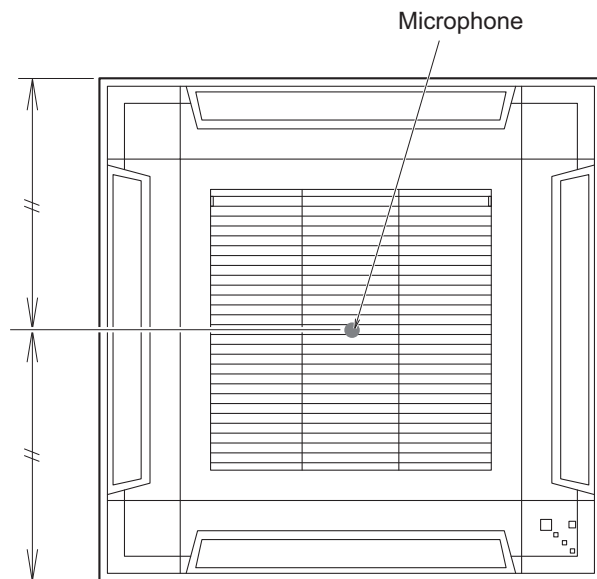

■ Mini duct type , Slim duct type, and Medium static pressure duct type

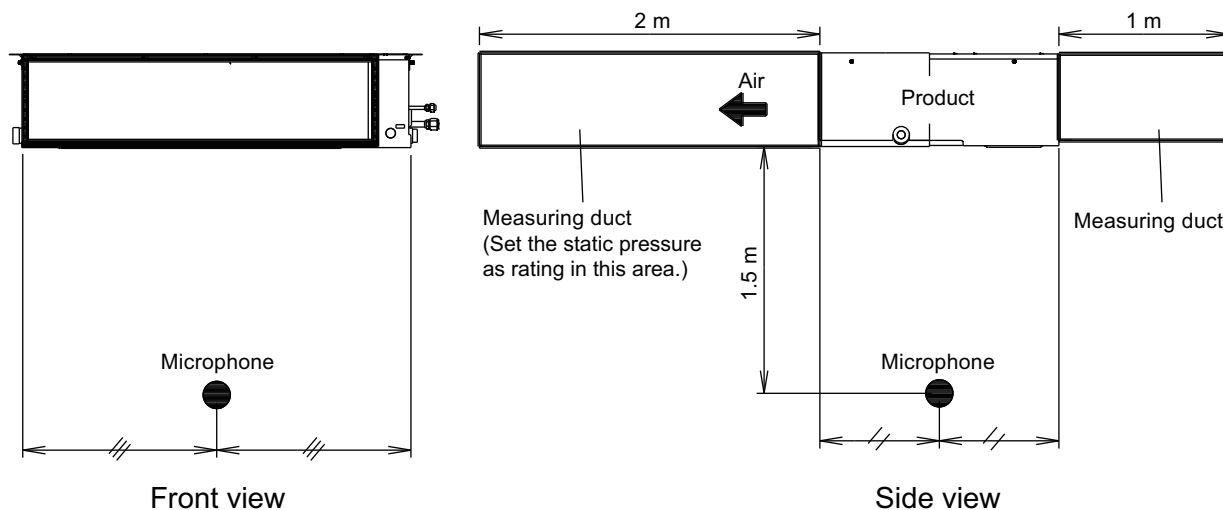

NOTE: Detailed shape of the actual indoor unit might be slightly different from the one illustrated above.

■ Wall mounted type

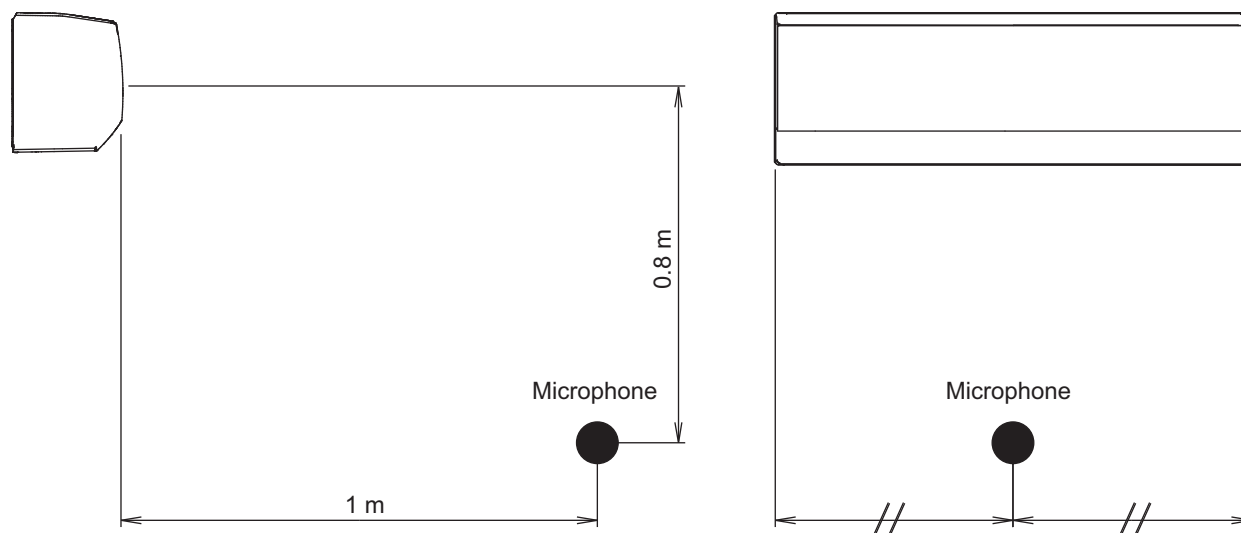

NOTE: Detailed shape of the actual indoor unit might be slightly different from the one illustrated above.

■ Floor type

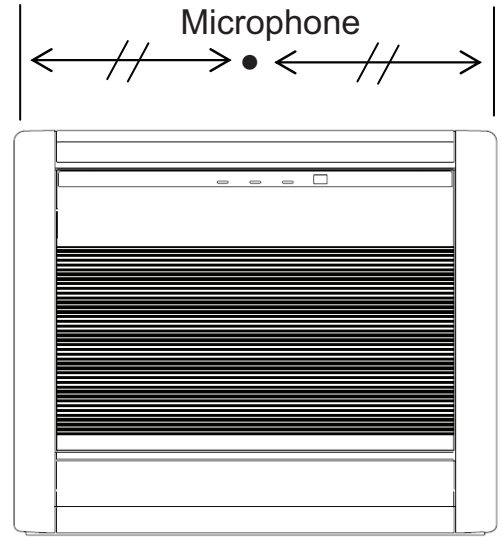
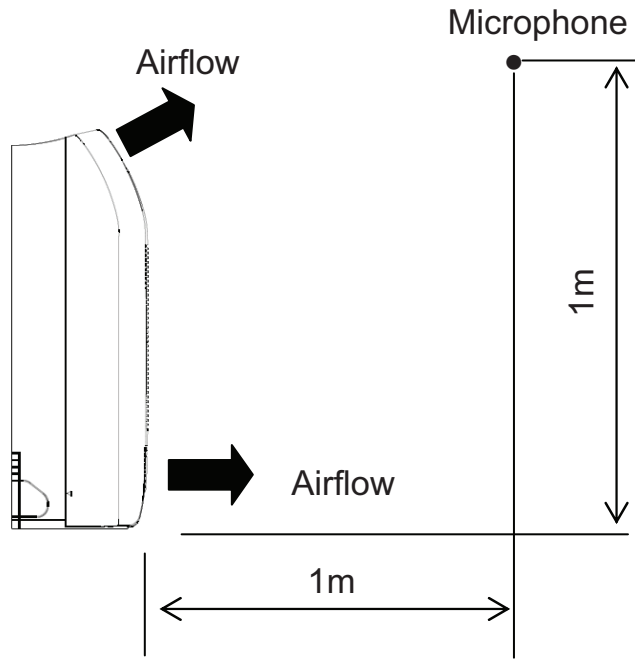

10. Electrical characteristics

		Power supply (50 Hz, 230 V)	Indoor rated		Wiring spec. of connection cable (Indoor unit to outdoor unit)	
Type	Model name	MCA	Input power	FLA	Cross-sectional area (mm ²)	Limited wiring length (m)
		(A)	(W)	(A)		
Compact cassette	AUXG07KVLA	0.19	18	0.15	1.5	21
	AUXG09KVLA	0.19	18	0.15		
	AUXG12KVLA	0.24	23	0.19		
	AUXG14KVLA	0.28	28	0.22		
Mini duct	ARXG07KSLAP	0.33	33	0.29	1.5	21
	ARXG09KSLAP	0.38	40	0.33		
	ARXG12KSLAP	0.42	47	0.38		
	ARXG14KSLAP	0.67	72	0.58		
Slim duct	ARXG07KLLAP	0.41	33	0.33	1.5	21
	ARXG09KLLAP	0.38	49	0.30		
	ARXG12KLLAP	0.44	58	0.35		
	ARXG14KLLAP	0.64	76	0.51		
Medium static pressure duct	ARXH12KMTAP	0.43	46	0.34	1.5	21
	ARXH14KMTAP	0.62	70	0.49		
Wall mounted	ASEH07KMCG ASEH07KMCG-B	0.25	23	0.20	1.5	21
	ASEH09KMCG ASEH09KMCG-B	0.30	27	0.24		
	ASEH12KMCG ASEH12KMCG-B	0.30	27	0.24		
	ASEH14KMCG ASEH14KMCG-B	0.38	33	0.30		
Wall mounted	ASEG07KETF ASEG07KETF-B	0.25	23	0.20	1.5	21
	ASEG09KETF ASEG09KETF-B	0.30	27	0.24		
	ASEG12KETF ASEG12KETF-B	0.30	27	0.24		
	ASEG14KETF ASEG14KETF-B	0.38	33	0.30		
Wall mounted	ASEH07KGTG	0.25	23	0.20	1.5	21
	ASEH09KGTG	0.30	27	0.24		
	ASEH12KGTG	0.30	27	0.24		
	ASEH14KGTG	0.37	33	0.29		
Wall mounted	ASEH05KNCA	0.14	12	0.11	1.5	21
	ASEH07KNCA	0.15	13	0.12		
	ASEH09KNCA	0.24	21	0.19		
	ASEH12KNCA	0.25	22	0.20		
Floor	AGEG09KVCA	0.19	16	0.15	1.5	21
	AGEG12KVCA	0.23	20	0.18		
	AGEG14KVCA	0.25	23	0.20		

MCA: Minimum Circuit Ampacity = Maximum operating current (Full load)

FLA: Full Load Amperes (Fan motor)

11. Safety devices

Indoor unit type	Model name	PCB* fuse	Fan motor thermal protector	Terminal thermal fuse	Float switch			
Compact cassette	AUXG07KVLA	250 V, 5 A	Activate: 100 ±15 °C Fan motor stop Reset: 95 ±10 °C Fan motor restart	—	○			
	AUXG09KVLA							
	AUXG12KVLA							
	AUXG14KVLA							
Mini duct	ARXG07KSLAP							
	ARXG09KSLAP							
	ARXG12KSLAP							
	ARXG14KSLAP							
Slim duct	ARXG07KLLAP							
	ARXG09KLLAP							
	ARXG12KLLAP							
	ARXG14KLLAP							
Medium static pressure duct	ARXH12KMTAP		250 V, 5 A			Activate: 135—150 °C Fan motor stop Reset: 105—120 °C Fan motor restart	—	○
	ARXH14KMTAP							
Wall mounted	ASEH07KMCG		250 V, 3.15 A			Activate: 170 ⁺²⁵ ₋₃₀ °C Fan motor stop Reset: 145 ⁺²⁵ ₋₃₀ °C Fan motor restart	—	—
	ASEH07KMCG-B							
	ASEH09KMCG							
	ASEH09KMCG-B							
	ASEH12KMCG							
	ASEH12KMCG-B							
Wall mounted	ASEG07KETF	250 V, 3.15 A	Activate: 110 ±15 °C Fan motor speed down Reset: 110 ±15 °C Fan motor speed recover	102 °C Off	—			
	ASEG07KETF-B							
	ASEG09KETF							
	ASEG09KETF-B							
	ASEG12KETF							
	ASEG12KETF-B							
	ASEG14KETF							
	ASEG14KETF-B							
Wall mounted	ASEH07KGTG	250 V, 3.15 A	Activate: 110 ±15 °C Fan motor speed down Reset: 110 ±15 °C Fan motor speed recover	102 °C Off	—			
	ASEH09KGTG							
	ASEH12KGTG							
	ASEH14KGTG							
Wall mounted	ASEH05KNCA	250 V, 3.15 A	Activate: More than 170 °C Fan motor stop Reset: 145 °C or less Fan motor recover	102 °C Off	—			
	ASEH07KNCA							
	ASEH09KNCA							
	ASEH12KNCA							
Floor	AGEG09KVCA	250V, 5.0 A	Activate: 150 ±15 °C Fan motor stop Reset: 120 ±15 °C Fan motor restart	110 °C Off	—			
	AGEG12KVCA							
	AGEG14KVCA							

*: Printed Circuit Board

12. External input and output

12-1. Compact cassette type and Medium static pressure duct type

• Compact cassette type

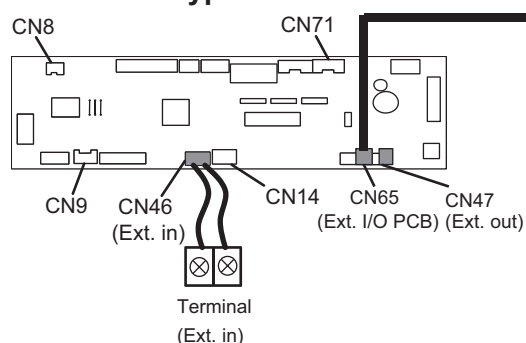

Fig. Indoor unit PCB

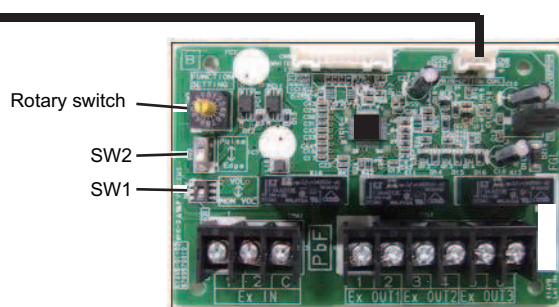

Fig. External Input and Output PCB

• Medium static pressure duct type

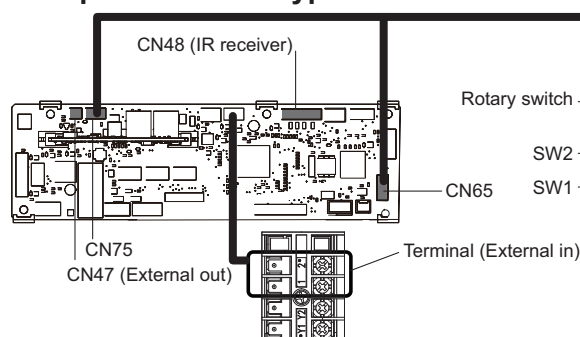

Fig. Indoor unit PCB

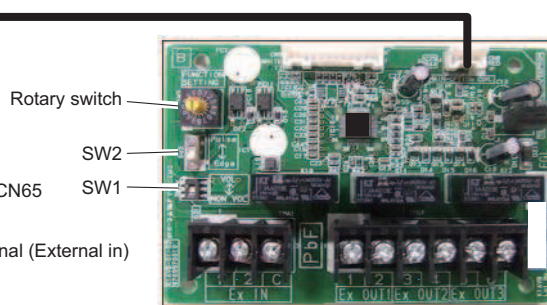

Fig. External Input and Output PCB

Connecting point		Input/Output	Function	Input select	Input signal
Indoor unit	Terminal	Input	Operation/Stop Forced stop	Dry contact	Edge
	CN47	Output	Operation/Stop Error status		
			Indoor unit fan operation status		
			External heater output		
External Input and Output PCB (UTY-XCSX)	Ex IN 1/2	Input	Operation/Stop Forced thermostat off	Dry contact/Apply voltage	Edge/Pulse
	Ex IN 1				Edge
	Ex OUT 1 Ex OUT 2 Ex OUT 3	Output	Operation/Stop Error status	—	—
			Indoor unit fan operation status		
			External heater output		

NOTE: For details of the switching function, refer to "[Setting of external input and output](#)" on page 126.

External input

With using external input function, some functions on this product can be controlled from an external device.

- “Operation/Stop” mode or “Forced stop” mode can be selected with function setting of indoor unit.
- A twisted pair cable should be used. Maximum length of cable is 150 m.
- Use an external input and output cable with appropriate external dimension, depending on the number of cables to be installed.
- The wire connection should be separate from the power cable line.

Indoor unit

Indoor unit functions such as Operation/Stop can be done by using indoor unit terminal.

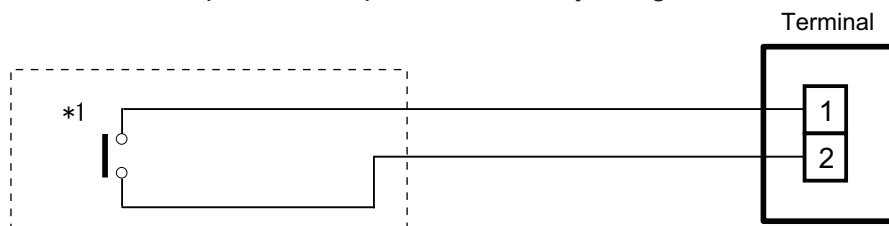

*1: The switch can be used on the following condition: DC 12 V to 24 V, 1 mA to 15 mA.

External Input and Output PCB

The indoor unit Operation/Stop can be set by using the input terminal on the PCB.

Input select

Use either one of these types of terminal according to the application. (Both types of terminal cannot be used simultaneously.)

– Dry contact

In case of internal power supply, set the slide switch of SW1 to “NON VOL” side.

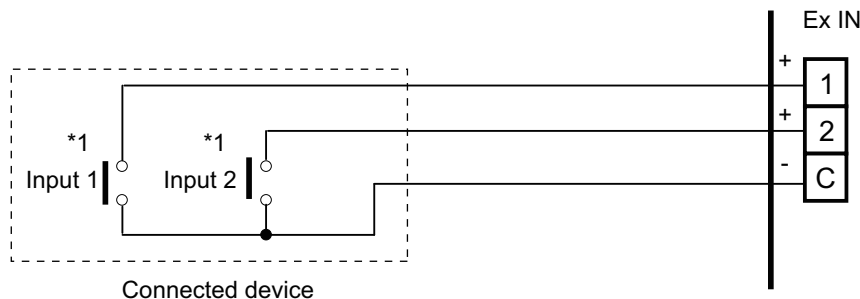

*1: The switches can be used on the following condition: DC 12 V to 24 V, 1 mA to 15 mA.

– Apply voltage

In case of external power supply, set the slide switch of SW1 to “VOL” side.

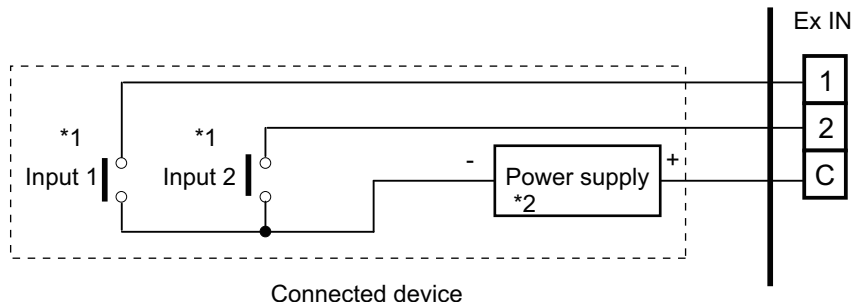

*1: The switches can be used on the following condition: DC 12 V to 24 V, 1 mA to 15 mA.

*2: Make the power supply DC 12 V to 24 V, 10 mA or more.

● Input signal type

• Indoor unit

Input signal type is only "Edge".

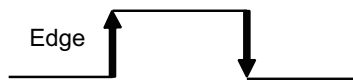

• External Input and Output PCB

The input signal type can be selected.

Signal type (edge or pulse) can be switched by the DIP switch 2 (SW2) on the External Input and Output PCB.

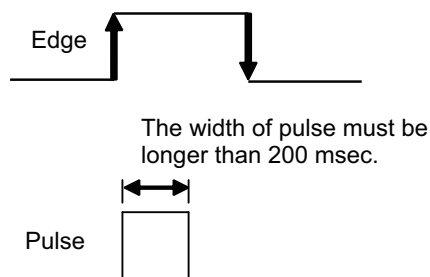

NOTE: The input signal supports the following switch type:

- Edge: Alternate type switch
- Pulse: Momentary type switch

External output

Use an external output cable with appropriate external dimension, depending on the number of cables to be installed.

Indoor unit

- A twisted pair cable (22 AWG) should be used. Maximum length of cable is 25 m.
- Output voltage: High DC 12 V \pm 2 V, Low 0 V.
- Permissible current: 50 mA
- For details, refer to ["Setting of external input and output"](#) on page 126.
- **When indicator, etc. are connected directly**

Example: Function setting number 60 is set to "00"

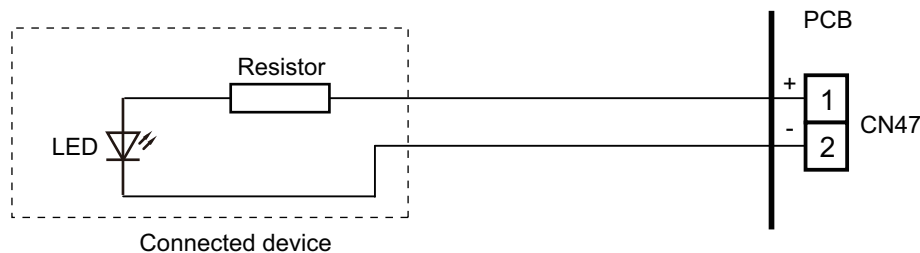

- **When connecting with a device equipped with a power supply**

Example: Function setting number 60 is set to "00"

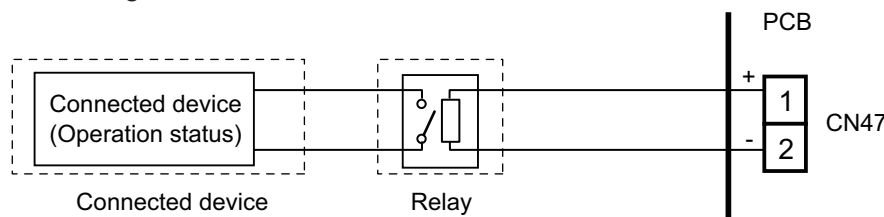

External Input and Output PCB

- A twisted pair cable (22 AWG) should be used.
- Permissible voltage and current: DC 5 V to 30 V/3 A, AC 30 V to 250 V/3 A
- For details, refer to ["Setting of external input and output"](#) on page 126.

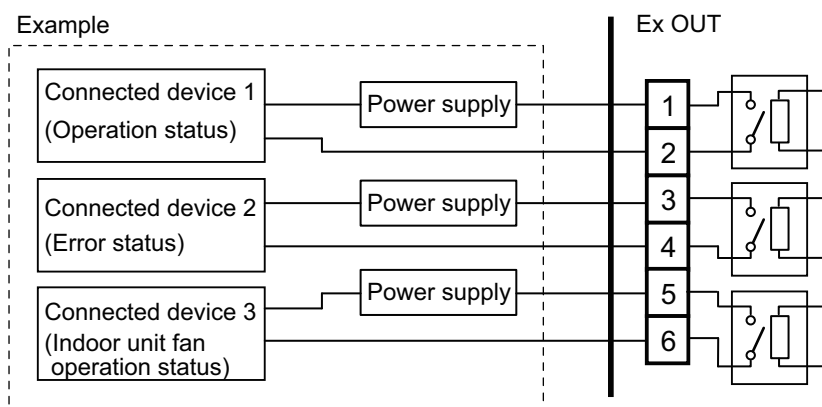

■ Setting of external input and output

• Indoor unit

Input		
Connecting point	Function setting number 46	Function
Terminal	00	Operation/Stop mode 1
	01	(Setting prohibited)
	02	Forced stop mode
	03	Operation/Stop mode 2

Output		
Connecting point	Function setting number 60	Function
CN47	00	Operation/Stop
	01 to 08	(Setting prohibited)
	09	Error status
	10	Indoor unit fan operation status
	11	External heater output

• External Input and Output PCB

Switch setting		Input		Output		
Rotary switch	SW2	Ex IN 1	Ex IN 2	Ex OUT 1	Ex OUT 2	Ex OUT 3
1	Edge	Operation/Stop	Not available	Operation/Stop	Error status	Indoor unit fan operation status
	Pulse	Operation	Stop			
2	Edge*	Forced thermostat off	Not available	Error status	Indoor unit fan operation status	External heater output
3 to 9, A		(Setting prohibited)				
B		Forced thermostat off	Not available	Operation/Stop	Indoor unit fan operation status	External heater output
C		Forced thermostat off	Not available	Operation/Stop	Error status	External heater output
D		Forced thermostat off	Not available	Operation/Stop	Indoor unit fan operation status	Error status

NOTES:

- When the rotary switch is selected to "1", the operation of the terminal input of the indoor unit and the External Input and Output PCB input are the same. The operation content depends on the setting of function setting number 46.
- *: The external input other than "Operation/Stop" is available only when the SW2 is set to "Edge".

■ Details of control input function

● Operation/Stop mode 1

- In the case of "Edge" input

Function setting	External Input and Output PCB		External input		Input signal	Command
	Rotary switch	SW2				
46-00	—		Input of indoor unit	Terminal	Off → On	Operation
	—				On → Off	Stop
	1	Edge	External Input and Output PCB	Ex IN 1	Off → On	Operation
					On → Off	Stop

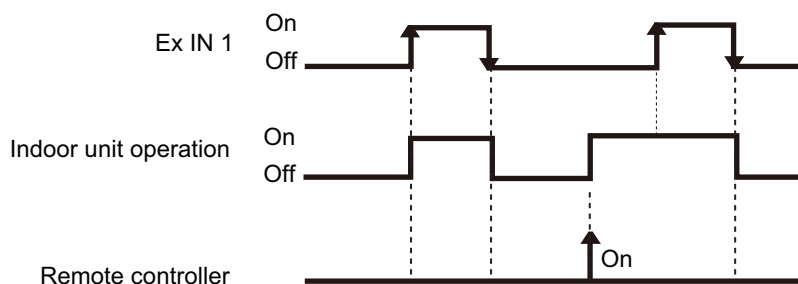

- In the case of "Pulse" input

Function setting	External Input and Output PCB		External input		Input signal	Command
	Rotary switch	SW2				
46-00	1	Pulse	External Input and Output PCB	Ex IN 1	Pulse	Operation
				Ex IN 2		Stop

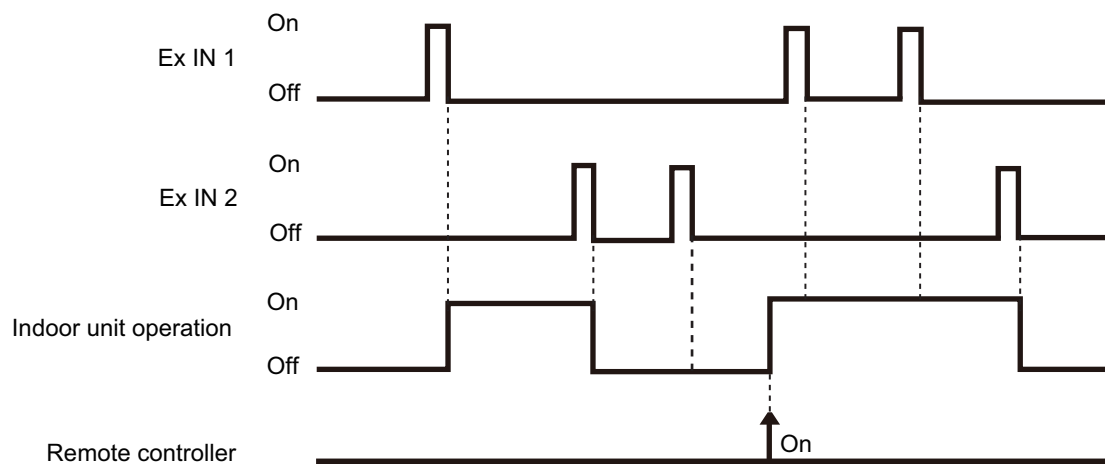

NOTES:

- The last command has priority.
- The indoor units within the same remote controller group operates in the same mode.

● Forced stop

- In the case of "Edge" input

Function setting	External Input and Output PCB		External input		Input signal	Command
	Rotary switch	SW2				
46-02	—		Input of indoor unit	Terminal	Off → On	Forced stop (R.C. disabled)
					On → Off	Normal (R.C. enabled)
	1	Edge	External Input and Output PCB	Ex IN 1	Off → On	Forced stop (R.C. disabled)
					On → Off	Normal (R.C. enabled)

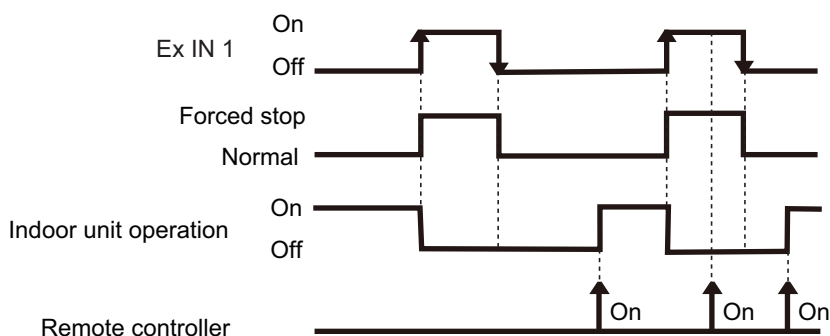

- In the case of "Pulse" input

Function setting	External Input and Output PCB		External input		Input signal	Command
	Rotary switch	SW2				
46-02	1	Pulse	External Input and Output PCB	Ex IN 1	Pulse	Forced stop (R.C. disabled)
				Ex IN 2		Normal (R.C. enabled)

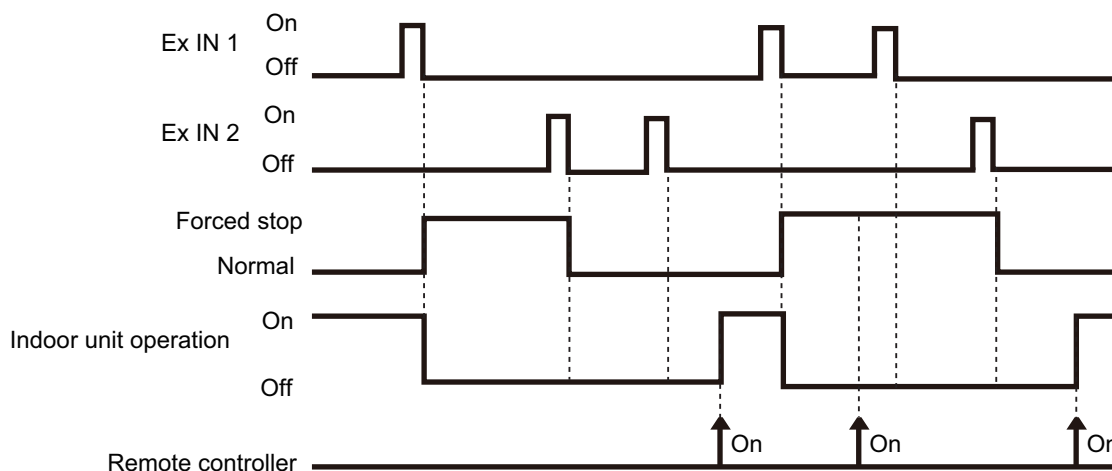

NOTES:

- When the forced stop is triggered, indoor unit stops and Operation/Stop operation by the remote controller is restricted.
- When forced stop function is used with forming a remote controller group, connect the same equipment to each indoor unit within the group.

● Operation/Stop mode 2

- In the case of "Edge" input

Function setting	External Input and Output PCB		External input		Input signal	Command
	Rotary switch	SW2				
46-03	—		Input of indoor unit	Terminal	Off → On	Operation (R.C. enabled)
					On → Off	Stop (R.C. disabled)
	1	Edge	External Input and Output PCB	Ex IN 1	Off → On	Operation (R.C. enabled)
					On → Off	Stop (R.C. disabled)

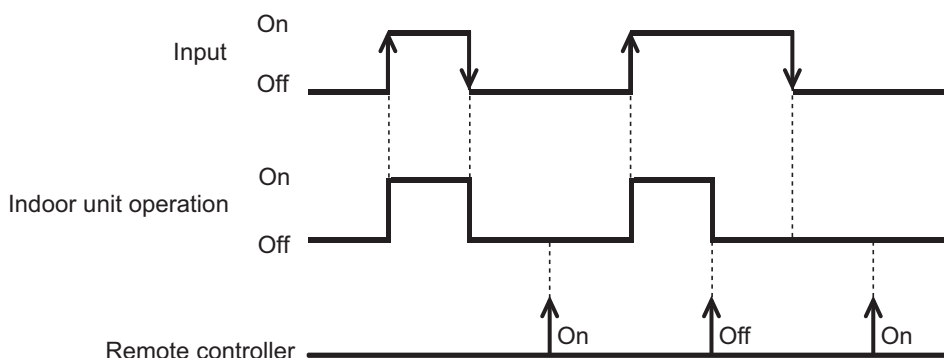

- In the case of "Pulse" input

Function setting	External Input and Output PCB		External input		Input signal	Command
	Rotary switch	SW2				
46-03	1	Pulse	External Input and Output PCB	Ex IN 1	Pulse	Operation (R.C. enabled)
				Ex IN 2		Stop (R.C. disabled)

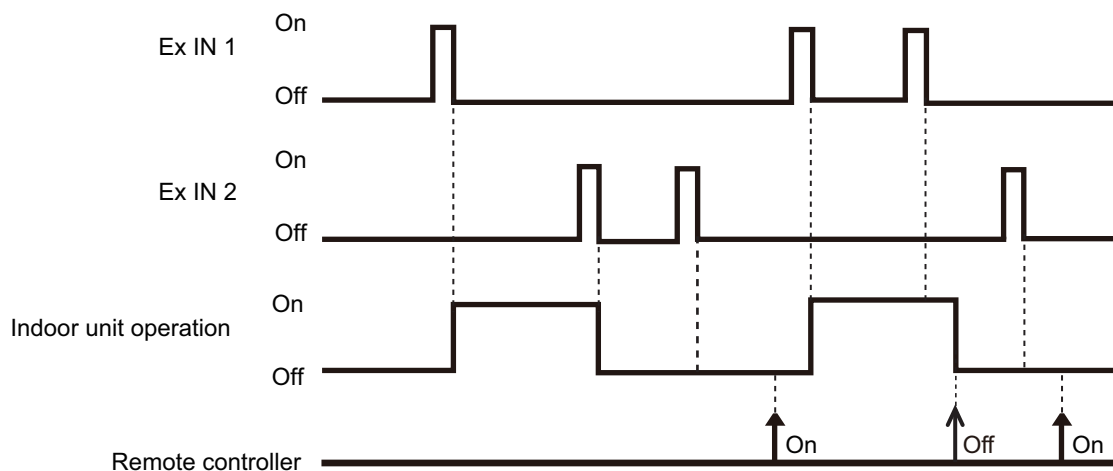

NOTE: When "Operation/Stop" mode 2 function is used with forming a remote controller group, connect the same equipment to each indoor unit within the group.

● Forced thermostat off

External Input and Output PCB	External input		Input signal	Command
Rotary switch				
2, B, C, D	External Input and Output PCB	Ex IN 1	Off → On	Thermostat off
			On → Off	Normal operation

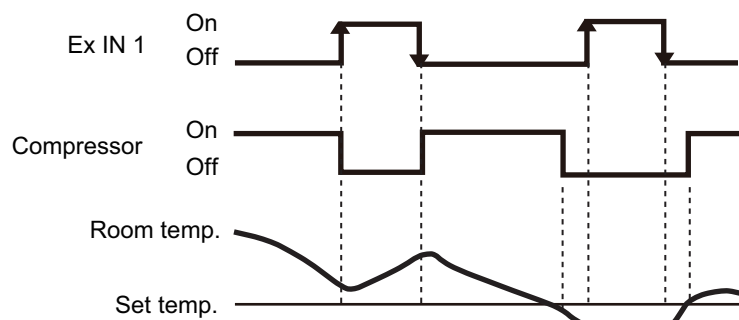

NOTE: When the signal is received from another unit on the refrigerant circuit, there may be a delay in thermostat off function at the unit.

■ Details of control output function

● Operation status

Function setting	External Input and Output PCB	External output		Output signal	Status
	Rotary switch				
60-00	—	Output of indoor unit	CN47	Off → On	Operation
				On → Off	Stop
—	1, B, C, D	External Input and Output PCB	Ex OUT 1	Off → On	Operation
				On → Off	Stop

The output is low when the unit is stopped.

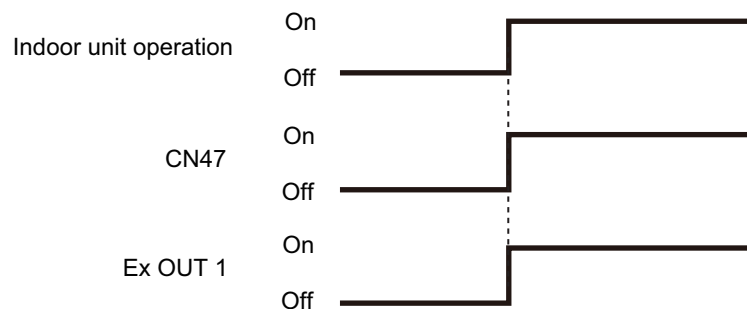

● Error status

Function setting	External Input and Output PCB	External output		Output signal	Status
	Rotary switch				
60-09	—	Output of indoor unit	CN47	Off → On	Error
				On → Off	Normal
—	2	External Input and Output PCB	Ex OUT 1	Off → On	Error
				On → Off	Normal
—	1, C	External Input and Output PCB	Ex OUT 2	Off → On	Error
				On → Off	Normal
—	D	External Input and Output PCB	Ex OUT 3	Off → On	Error
				On → Off	Normal

The output is on when an error is generated for the indoor unit.

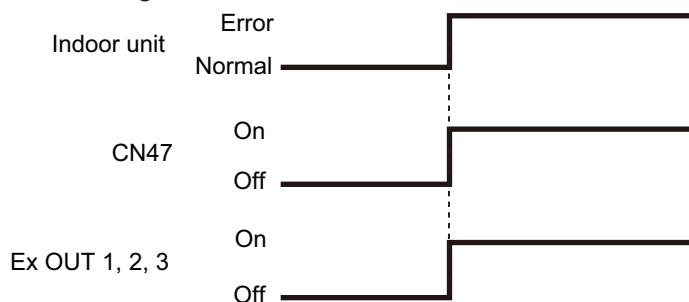

● Indoor unit fan operation status

Function setting	External Input and Output PCB	External output		Output signal	Status
	Rotary switch				
60-10	—	Output of indoor unit	CN47	Off → On	Fan run
				On → Off	Fan stop
—	2, B, D	External Input and Output PCB	Ex OUT 2	Off → On	Fan run
				On → Off	Fan stop
—	1	External Input and Output PCB	Ex OUT 3	Off → On	Fan run
				On → Off	Fan stop

Output signal	Condition
On	The indoor unit fan is operating.
Off	The fan is stopped or during cold air prevention. During thermostat off when in dry mode operation.

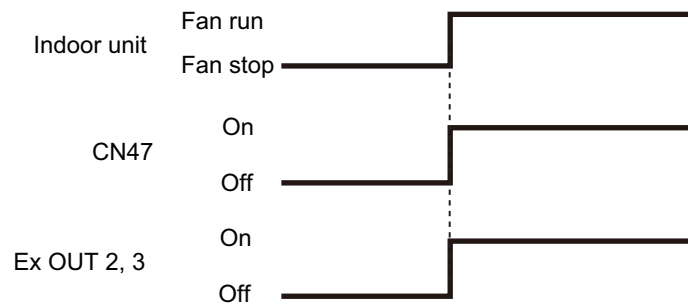

12-2. Mini duct type and Slim duct type

Exterior of the indoor unit PCB and the component location differ by the type of the indoor unit as follows.

- **Mini duct type and Slim duct types:**

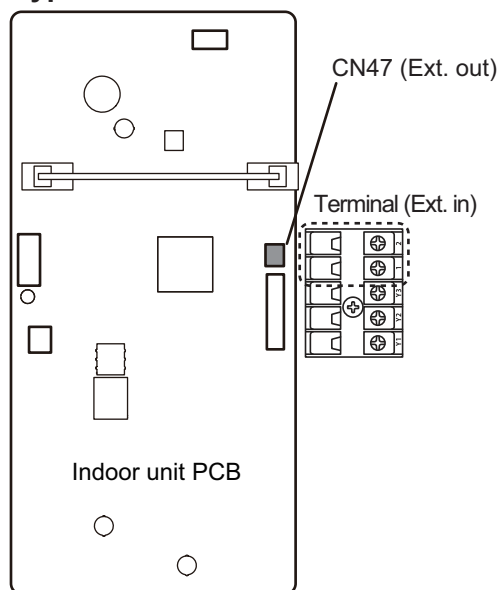

External input and output		Connector	Input select	Input signal	External connect kit (Optional parts)
External input	Operation/Stop Forced stop	Terminal	Dry contact	Edge	—
External output	Operation status	CN47	—	—	UTY-XWZXZG
	Error status				
	Indoor unit fan operation status				
	External heater output				

External input

With using external input function, some functions on this product can be controlled from an external device.

- "Operation/Stop" mode or "Forced stop" mode can be selected with function setting of indoor unit.
- A twisted pair cable (22AWG) should be used. Maximum length of cable is 150 m.
- The wire connection should be separate from the power cable line.

Indoor unit functions such as Operation/Stop can be done by using indoor unit terminals.

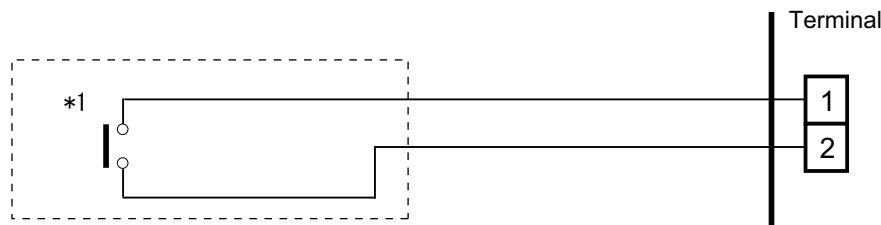

*1: The switch can be used on the following condition: DC 12 V to 24 V, 1 mA to 15 mA.

External output

Use an external output cable with appropriate external dimension, depending on the number of cables to be installed.

- A twisted pair cable (22AWG) should be used. Maximum length of cable is 25 m.
- Output voltage: High DC 12 V \pm 2 V, Low 0 V.
- Permissible current: 50 mA
- For details, refer to "[Combination of external input and output](#)" on page 135.

When indicator, etc. are connected directly

Example: Function setting 60 is set to "00"

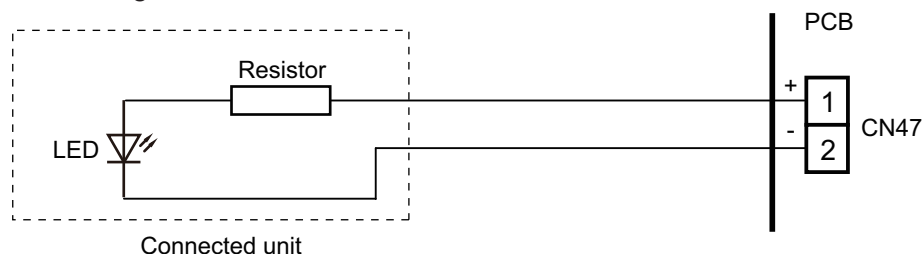

When connecting with a device equipped with a power supply

Example: Function setting 60 is set to "00"

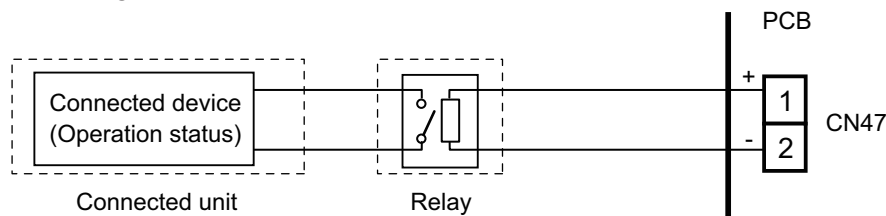

■ Combination of external input and output

By combining the function setting of the indoor unit, you can select various combinations of functions.

Combination examples of external input and output are as follows:

Mode	Function setting	External input	External output
		Terminal	CN47
0	60—00	Operation/Stop	
1—8	60—01 to 60—08	(Setting prohibited)	
9	60—09	Operation/Stop	Error status
10	60—10	Operation/Stop	Indoor unit fan operation status
11	60—11	Operation/Stop	External heater output

NOTE: Input of Operation/Stop depends on the setting of function setting 46.

- 00: Operation/Stop mode 1 (Remote controller enabled)
- 01: (Setting prohibited)
- 02: Forced stop
- 03: Operation/Stop mode 2 (Remote controller disabled)

● Input signal type

- Indoor unit
Input signal type is only "Edge".



■ Details of function

● Control input function

- When function setting is "Operation/Stop" mode 1

Function setting	External input	Input signal	Command
46—00	Terminal	Off → On	Operation
		On → Off	Stop

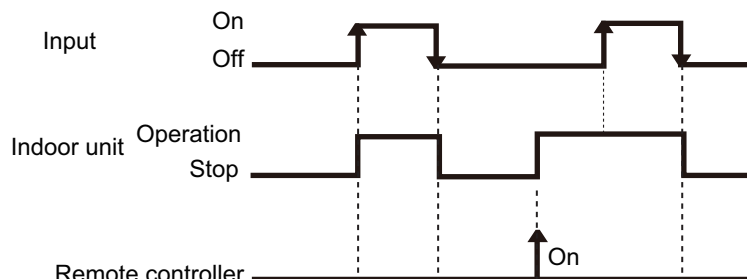

NOTES:

- The last command has priority.
- The indoor units within the same remote controller group operates in the same mode.

- When function setting is "Forced stop" mode

Function setting	External input	Input signal	Command
46—02	Terminal	Off → On	Forced stop
		On → Off	Normal

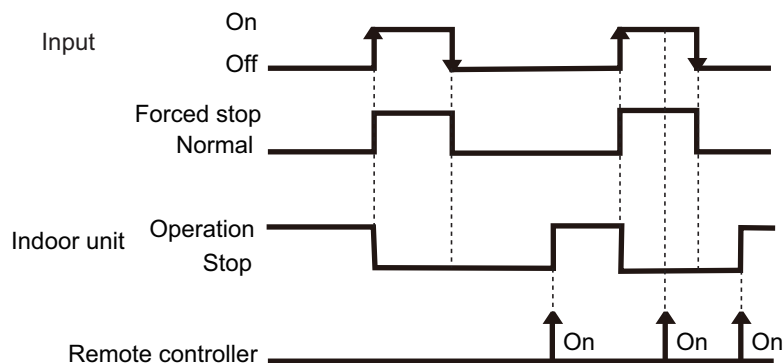

NOTES:

- When the forced stop is triggered, indoor unit stops and Operation/Stop operation by the remote controller is restricted.
- When forced stop function is used with forming a remote controller group, connect the same equipment to each indoor unit within the group.

- When function setting is "Operation/Stop" mode 2

Function setting	External input	Input signal	Command
46—03	Terminal	Off → On	Operation
		On → Off	Stop (Remote controller disabled)

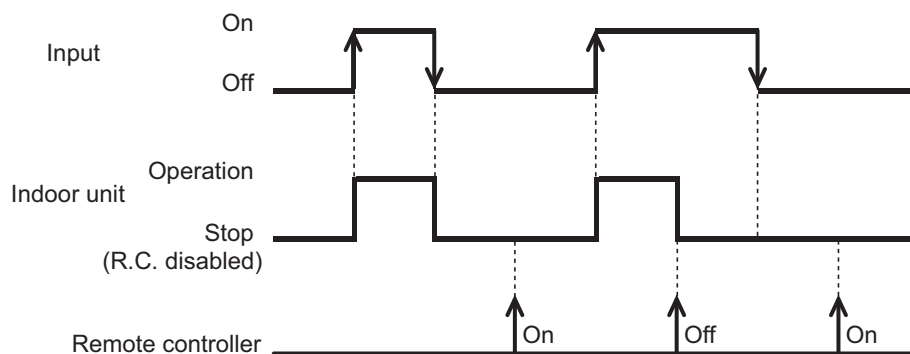

NOTE: When "Operation/Stop" mode 2 function is used with forming a remote controller group, connect the same equipment to each indoor unit within the group.

● Control output function

Function setting	External output	Output signal	Command
60—00	CN47	Low → High	Operation
		High → Low	Stop

The output is low when the unit is stopped.

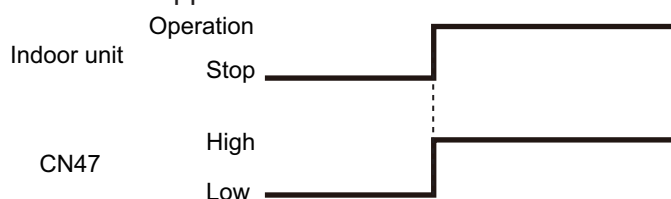

● Error status

Function setting	External output	Output signal	Command
60—09	CN47	Low → High	Error
		High → Low	Normal

The output is ON when an error is generated for the indoor unit.

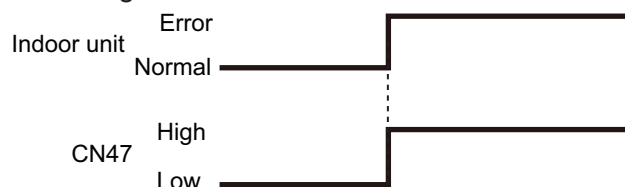

● Indoor unit fan operation status

Function setting	External output	Output signal	Command
60—10	CN47	Low → High	Fan run
		High → Low	Fan stop

Output signal	Condition
On	The indoor unit fan is operating.
Low → High	
Off	The fan is stopped or during cold air prevention. During thermostat off when in dry mode operation.
High → Low	

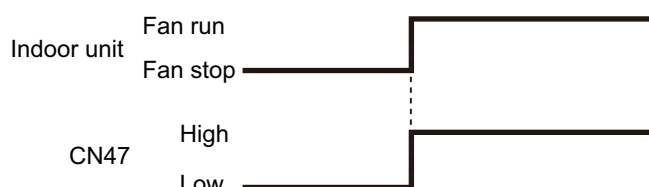

● External heater output

Function setting	External output	Output signal	Command
60—11	CN47	Low → High	Heater on
		High → Low	Heater off

Output signal	Condition
Low → High	Heater turns on as shown in diagram of heating temperature
Off → On	
High → Low	Heater turns off as shown in diagram of heating temperature
On → Off	<ul style="list-style-type: none"> • Other than Heating mode • Error occurred • Forced thermo off • Fan stop protection

Specifications of the signal output performance are as shown as follows:

Example When set temperature (T_s) is set at 22 °C;

- And room temperature (T_r) increase above 12 °C, signal output is on.
- And T_r increase above 21 °C, signal output is off.
- And T_r decrease below 19 °C, signal output is on.
- And T_r decrease below 10 °C, signal output is off.

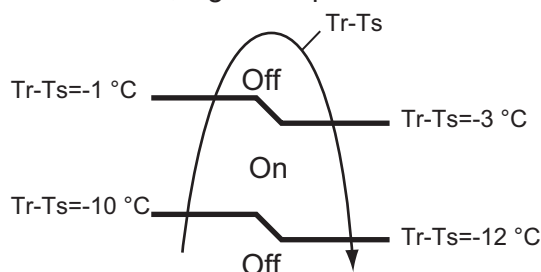

The output also turns off in defrost operation.

12-3. Wall mounted type (KMCG, KMCG-B, KETF, KETF-B, and KGTG)

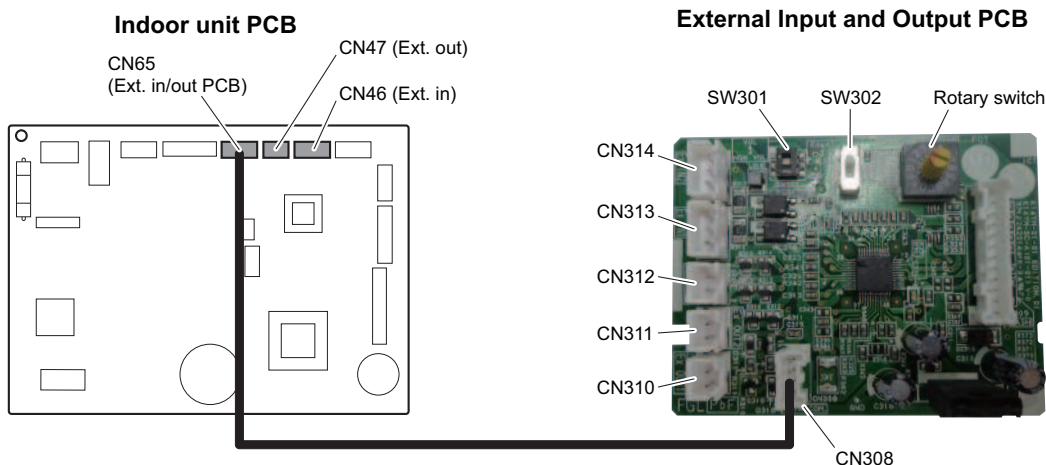

PCB	External input	External output	Connector	Input select	Input signal
Indoor unit	Operation/Stop	—	CN46	Dry contact	Edge
	Forced stop				
	—	Operation status	CN47	—	—
	Error status				
External Input and Output PCB (UTY-XCSXZ2)	Operation/Stop	—	CN313/	Dry contact/	Edge/Pulse
	Forced stop		CN314		
	Forced thermostat off		CN313	Apply voltage	Edge
	—	Operation status	CN310/ CN311/ CN312	—	—
	Error status				
	Indoor unit fan operation status				

External input

With using external input function, some functions on this product can be controlled from an external device.

- "Operation/Stop" mode or "Forced stop" mode can be selected with function setting of indoor unit.
- A twisted pair cable should be used. Maximum length of cable is 150 m.
- The wire connection should be separate from the power cable line.

Indoor unit

Indoor unit functions such as Operation/Stop can be done by using indoor unit connectors.

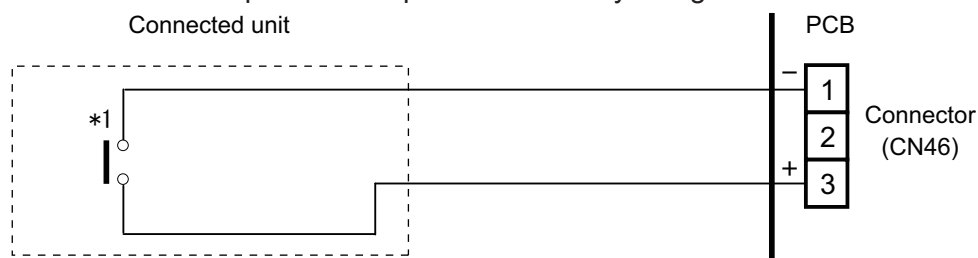

*1: The switch can be used on the following condition: DC 12 V to 24 V, 1 mA to 15 mA.

● External Input and Output PCB

The indoor unit Operation/Stop can be set by using the input connector on the PCB.

• Input select:

Use either one of these types of connectors according to the application. (Both types of connectors cannot be used simultaneously.)

– Dry contact

In case of internal power supply, set the slide switch of SW301 to "NON VOL" side.

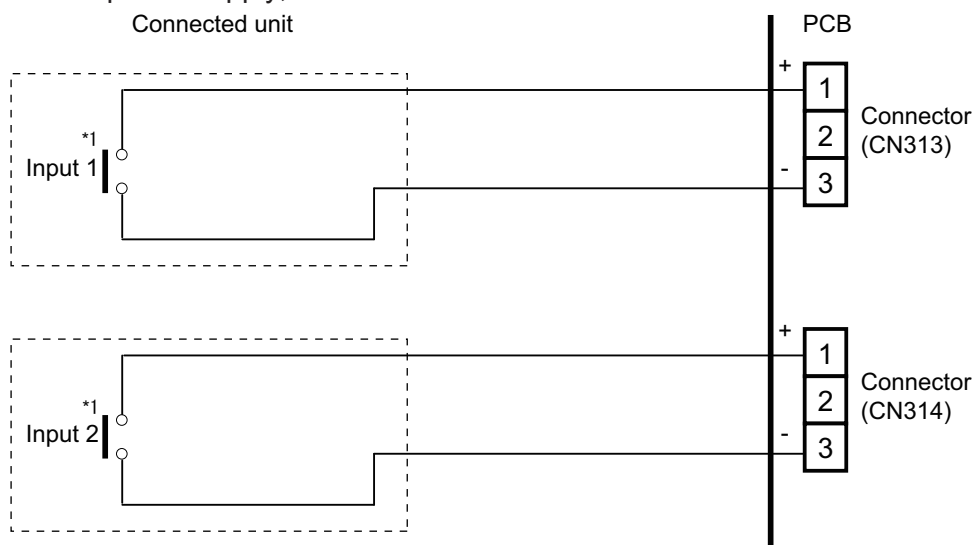

*1: The switches can be used on the following condition: DC 12 V to 24 V, 1 mA to 15 mA.

– Apply voltage

In case of external power supply, set the slide switch of SW301 to "VOL" side.

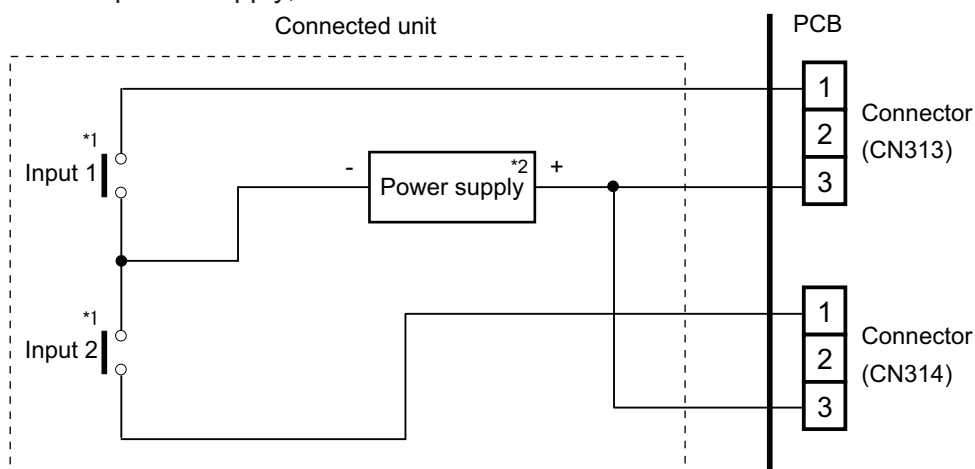

*1: The switches can be used on the following condition: DC 12 V to 24 V, 1 mA to 15 mA.

*2: Make the power supply DC 12 to 24 V, 10 mA or more.

External output

Use an external output cable with appropriate external dimension, depending on the number of cables to be installed.

Indoor unit

- A twisted pair cable should be used. Maximum length of cable is 25 m.
- Output voltage: High DC 12 V \pm 2 V, Low 0 V.
- Permissible current: 50 mA
- For details, refer to ["Combination of external input and output"](#) on page 144

When indicator or other components are connected directly

Example: Function setting 60 is set to "00"

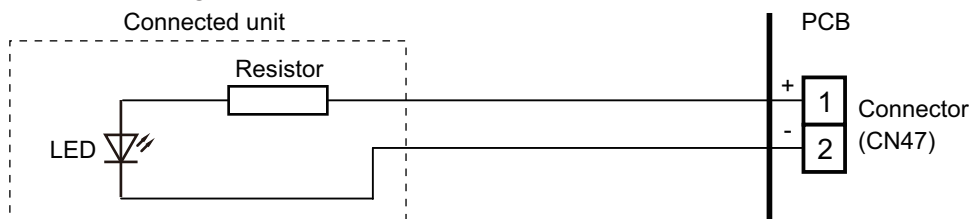

When connecting with a device equipped with a power supply

Example: Function setting 60 is set to "00"

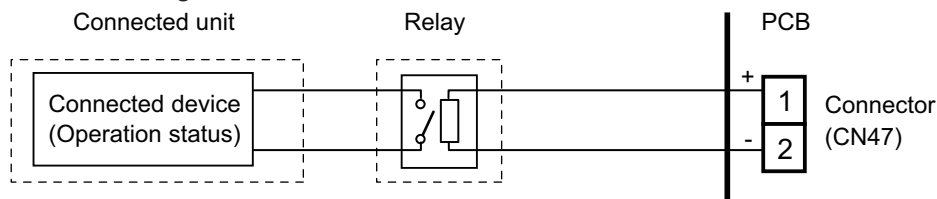

● External Input and Output PCB

- A twisted pair cable should be used. Maximum length of cable is 25 m.
- Output voltage: High DC 12 V \pm 2 V, Low 0 V.
- Permissible current: 50 mA
- For details, refer to "[Combination of external input and output](#)" on page 144

• When indicator or other components are connected directly:

Example: Rotary SW on External Input and Output PCB is set to "1".

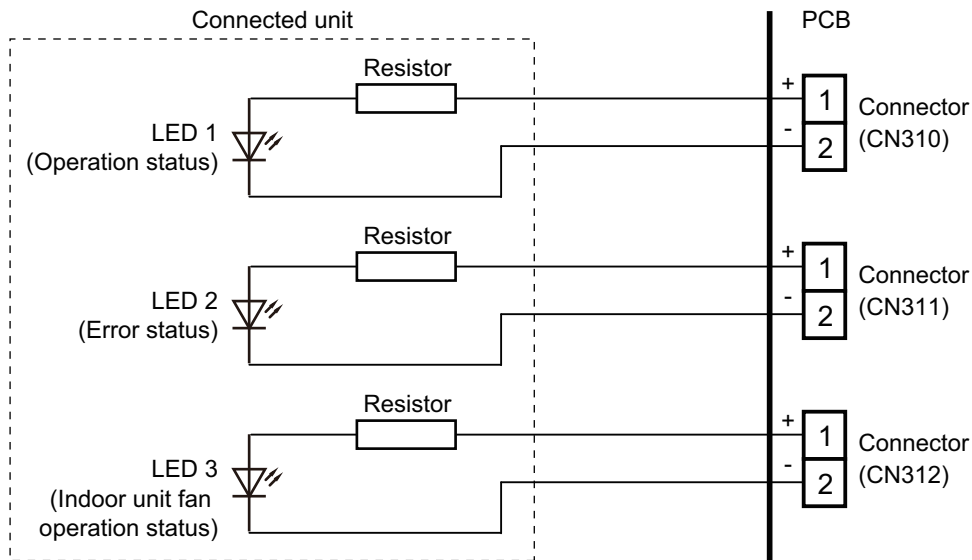

• When connecting with a device equipped with a power supply:

Example: Rotary SW on External Input and Output PCB is set to "1".

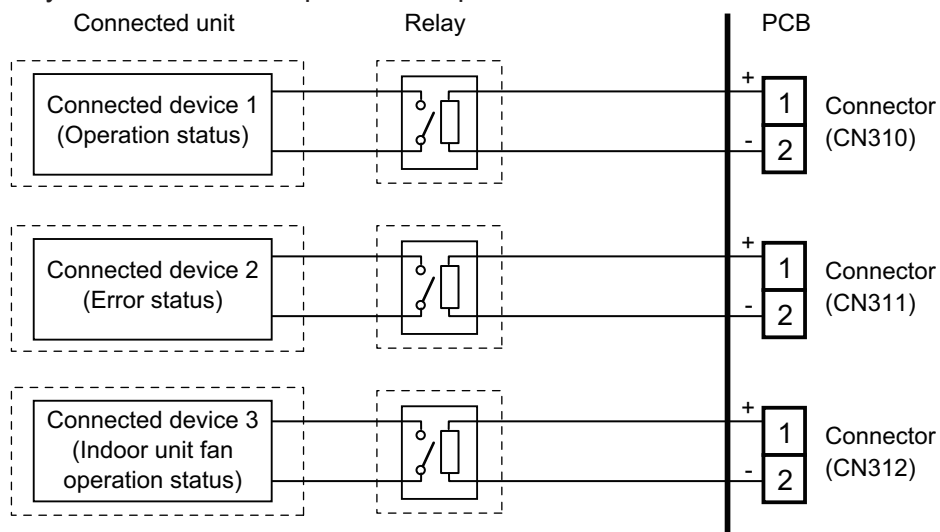

■ Combination of external input and output

By combining the function setting of the indoor unit and rotary switch setting of the External Input and Output PCB, you can select various combinations of functions.

Combination examples of external input and output are as follows:

Mode	Function setting	Rotary SW	External input		
			Indoor unit	External Input and Output PCB	
			CN46	CN313	CN314
0-1	60—00	1	Operation/Stop mode1 (Function setting 46-00) or Forced stop (Function setting 46-02) or Operation/Stop mode2 (Function setting 46-03)	Operation/Stop	Not available
				Operation	Stop
0-2	60-00	2		Forced thermostat OFF	Not available
1—8	60-01—08	3—9, A	(Setting prohibited)		
9	60-09	B	Operation/Stop mode1 (Function setting 46-00) or Forced stop (Function setting 46-02) or Operation/Stop mode2 (Function setting 46-03)	Forced thermostat OFF	Not available
10	60-10	C			
11	60-11	D	(Setting prohibited)		

Mode	Function setting	Rotary SW	External output			
			Indoor unit	External Input and Output PCB		
			CN47	CN310	CN311	CN312
0-1	60-00	1	Operation/Stop	Operation/Stop	Error status	Indoor unit fan operation status
0-2	60-00	2	Operation/Stop	Error status	Indoor unit fan operation status	Not available
1—8	60-01—08	3—9, A	(Setting prohibited)			
9	60-09	B	Error status	Operation/Stop	Indoor unit fan operation status	Not available
10	60-10	C	Indoor unit fan operation status		Error status	
11	60-11	D	(Setting prohibited)			

NOTE: Input of Operation/Stop depends on the setting of function setting 46.

00: Operation/Stop mode 1 (Remote controller enabled)

01: (Setting prohibited)

02: Forced stop

03: Operation/Stop mode 2 (Remote controller disabled)

● Input signal type

External Input and Output PCB:

The input signal type can be selected.

Signal type (edge or pulse) can be switched by the DIP switch SW302 on the External Input and Output PCB.

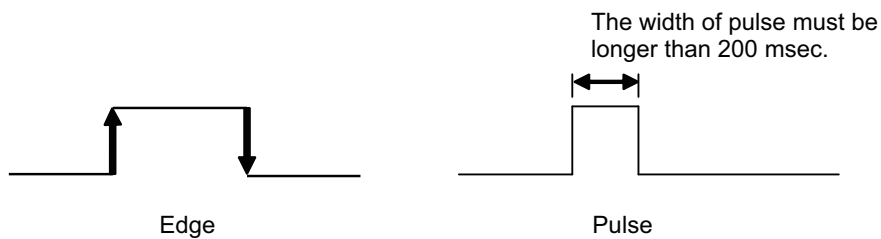

■ Details of function

● Control input function

- When function setting is “Operation/Stop” mode 1
 - In the case of “Edge” input:

Function setting	Rotary SW on External Input and Output PCB	External input		Input signal	Command
		External Input and Output PCB	CN313		
46-00	1			Off → On	Operation
				On → Off	Stop

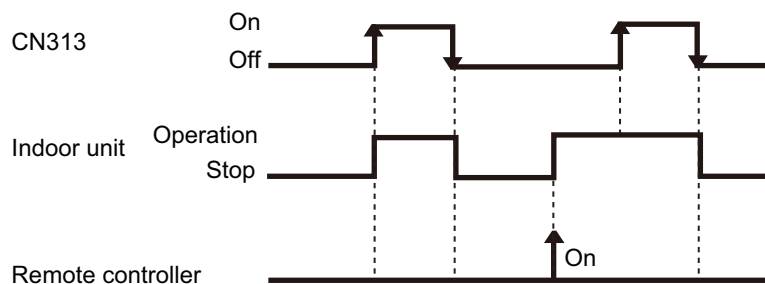

- In the case of “Pulse” input:

Function setting	Rotary SW on External Input and Output PCB	External input		Input signal	Command
		External Input and Output PCB	CN313		
46-00	1		CN313	Pulse	Operation
			CN314	Pulse	Stop

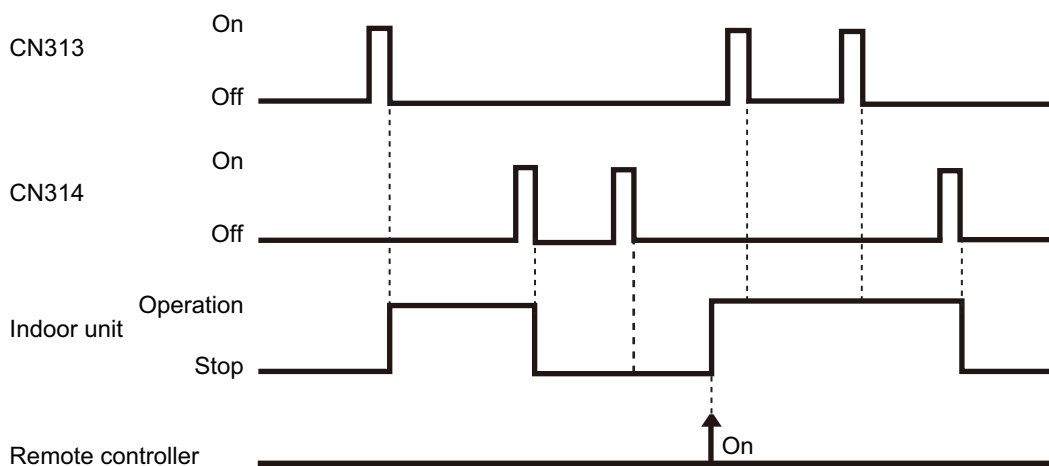

NOTES:

- The last command has priority.
- The indoor units within the same remote controller group operates in the same mode.

• When function setting is “Forced stop” mode

– In the case of “Edge” input:

Function setting	Rotary SW on External Input and Output PCB	External input		Input signal	Command
		External Input and Output PCB	CN313		
46-02	1			Off → On	Forced stop
				On → Off	Normal

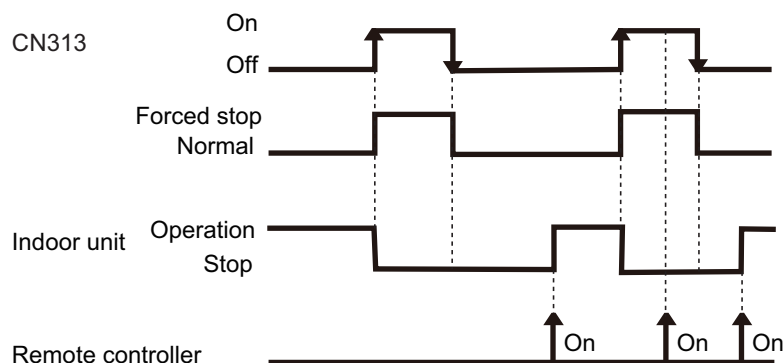

– In the case of “Pulse” input:

Function setting	Rotary SW on External Input and Output PCB	External input		Input signal	Command
		External Input and Output PCB	CN313 CN314		
46-02	1		CN313	Pulse	Forced stop
			CN314	Pulse	Normal

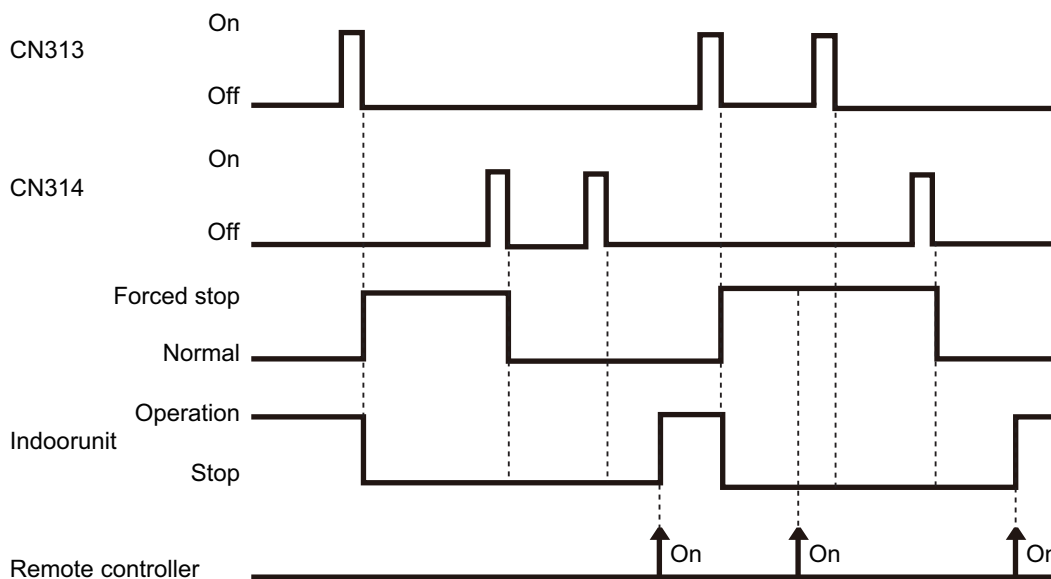

NOTES:

- When the forced stop is triggered, indoor unit stops and Operation/Stop operation by the remote controller is restricted.
- When forced stop function is used with forming a remote controller group, connect the same equipment to each indoor unit within the group.

• When function setting is “Operation/Stop” mode 2

– In the case of “Edge” input:

Function setting	Rotary SW on External Input and Output PCB	External input		Input signal	Command
46-03	1	External Input and Output PCB	CN313	Off → On	Operation
				On → Off	Stop (Remote controller disabled)

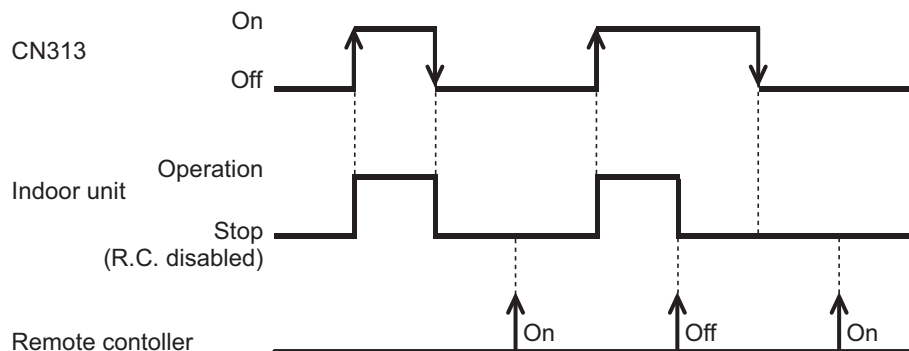

– In the case of “Pulse” input:

Function setting	Rotary SW on External Input and Output PCB	External input		Input signal	Command
46-03	1	External Input and Output PCB	CN313	Pulse	Operation
			CN314	Pulse	Stop (Remote controller disabled)

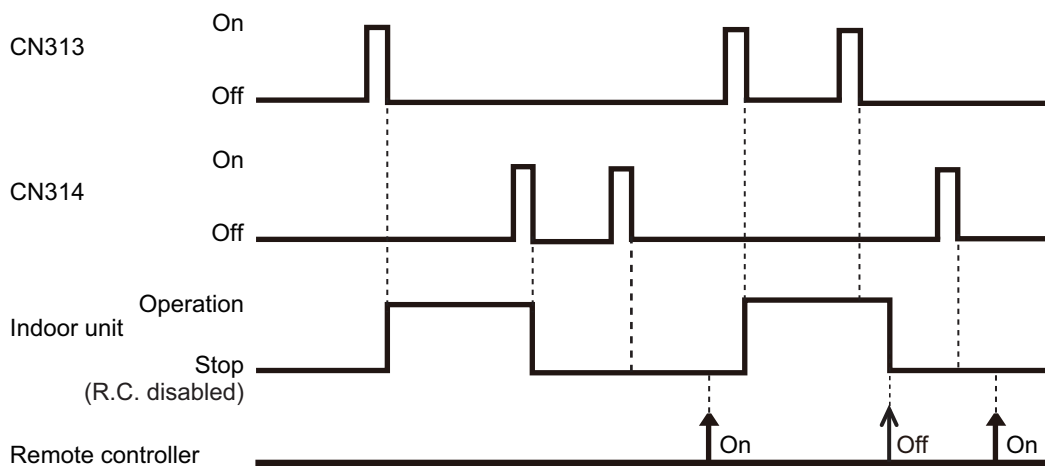

NOTE: When “Operation/Stop” mode 2 function is used with forming a remote controller group, connect the same equipment to each indoor unit within the group.

• Forced thermostat off function

Function setting / Rotary SW on External Input and Output PCB	External input		Input signal	Command
60-00 / 2 60-09 / B 60-10 / C	External Input and Output PCB	CN313	Off → On	Thermostat off
On → Off			Normal operation	

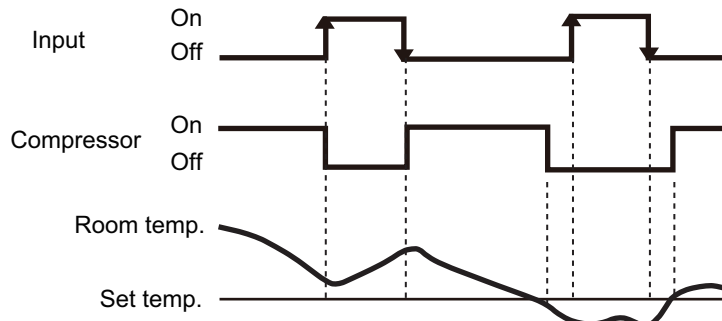

NOTE: When the signal is received from another unit on the refrigerant circuit, there may be a delay in thermostat off function at the unit.

● Control output function

• Operation/Stop status

Function setting / Rotary SW on External Input and Output PCB	External output	Output signal	Command
60-00 / 1 60-00 / 2	Output of indoor unit CN47	Off → On	Operation
		On → Off	Stop
60-00 / 1 60-09 / B 60-10 / C 60-11 / D	External Input and Output PCB CN310	Off → On	Operation
		On → Off	Stop

The output is low when the unit is stopped.

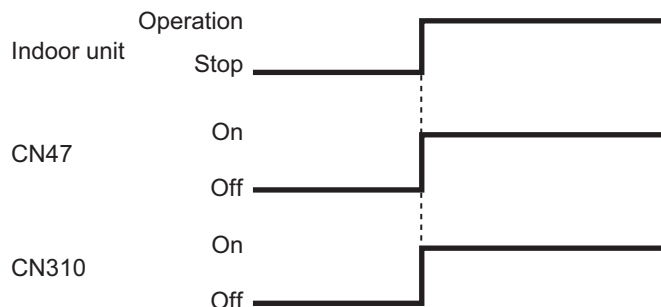

• Error status

Function setting / Rotary SW on External Input and Output PCB	External output	Output signal	Command
60-09 / B	Output of indoor unit CN47	Off → On	Error
		On → Off	Normal
60-00 / 2	External Input and Output PCB CN310	Off → On	Error
		On → Off	Normal
60-00 / 1 60-10 / C	External Input and Output PCB CN311	Off → On	Error
		On → Off	Normal
60-11 / D	External Input and Output PCB CN312	Off → On	Error
		On → Off	Normal

The output is ON when an error is generated for the indoor unit.

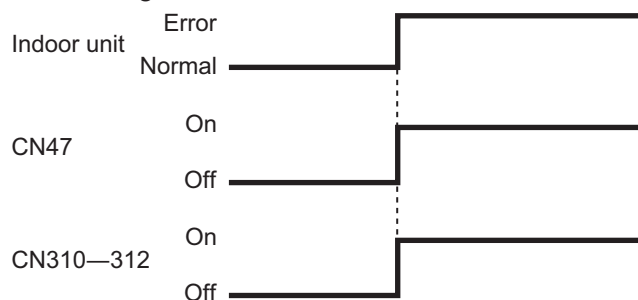

- Indoor unit fan operation status

Function setting / Rotary SW on External Input and Output PCB	External output		Output signal	Command
60-10 / C	Output of indoor unit	CN47	Off → On	Fan run
			On → Off	Fan stop
60-00 / 2 60-09 / B 60-11 / D	External Input and Output PCB	CN311	Off → On	Fan run
			On → Off	Fan stop
60-00 / 1		CN312	Off → On	Fan run
			On → Off	Fan stop

Output signal	Condition
On Low → High	The indoor unit fan is operating.
Off High → Low	The fan is stopped or during cold air prevention. During thermostat off when in dry mode operation.

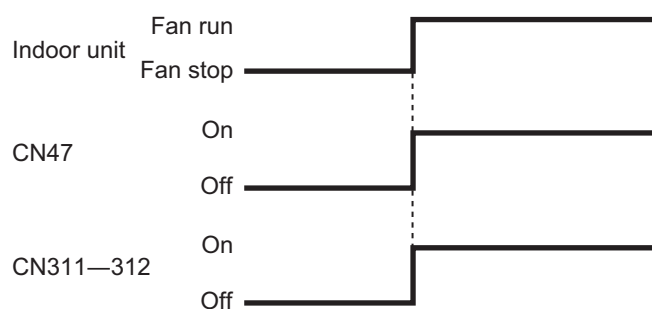

12-4. Floor type

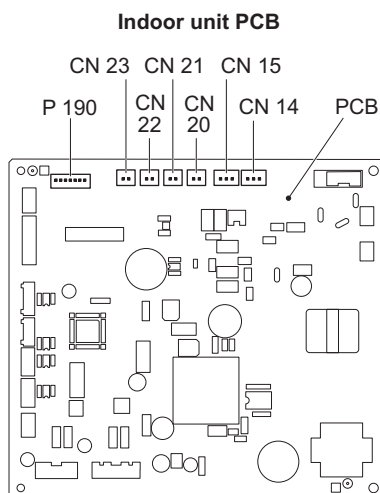

PCB	External input	External output	Connector	Input signal
Indoor unit	Operation/Stop	—	CN14	Edge
	Forced stop		CN15	
	Forced thermostat off			
	—	Operation status	CN20/CN21/ CN22/CN23	—
	Error status			
	Indoor unit fan operation status			
	External heater output			

External input

With using external input function, some functions on this product can be controlled from an external device.

- “Operation/Stop” mode can be selected with function setting of indoor unit.
- A twisted pair cable (22AWG) should be used. Maximum length of cable is 150 m.
- The wire connection should be separate from the power cable line.

Indoor unit

Indoor unit functions such as Operation/Stop can be done by using indoor unit connectors.

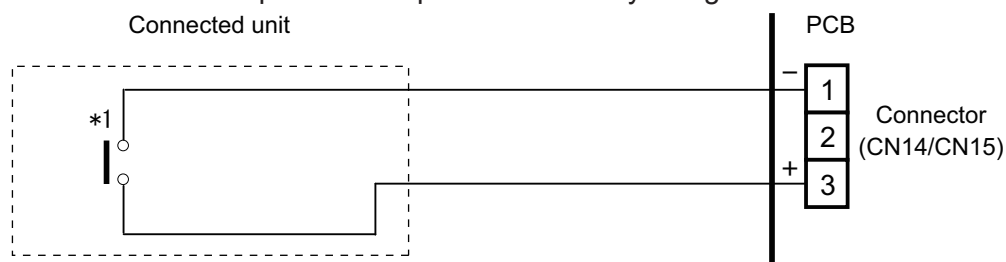

*1: The switch can be used on the following condition: DC 12 V to 24 V, 1 mA to 15 mA.

External output

Use an external output cable with appropriate external dimension, depending on the number of cables to be installed.

Indoor unit

- A twisted pair cable (22AWG) should be used. Maximum length of cable is 25 m .
- Output voltage: High DC 12 V \pm 2 V, Low 0 V.
- Permissible current: 50 mA
- For details, refer to Chapter 12-4-3. "[Combination of external input and output](#)" on page 154.

When indicator or other components are connected directly

Example: Function setting 60 is set to "00"

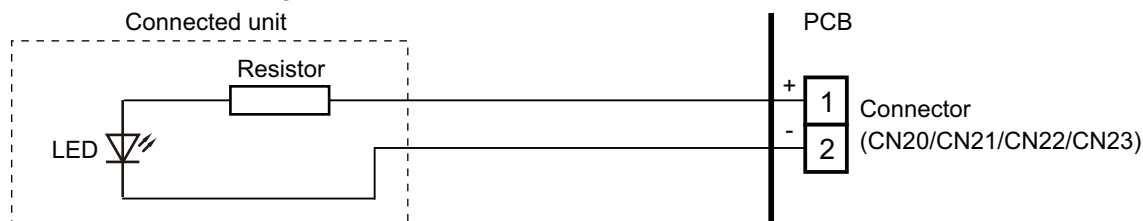

When connecting with a device equipped with a power supply

Example: Function setting 60 is set to "00"

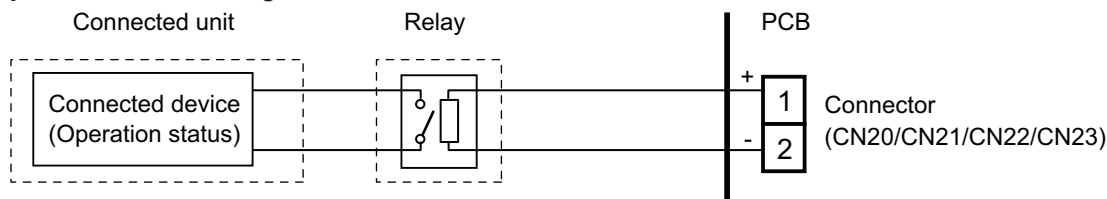

■ Combination of external input and output

By combining the function setting of the indoor unit, you can select various combinations of functions.

Combination examples of external input and output are as follows:

Mode	Function setting	External input	
		Indoor unit	
		CN14	CN15
0	60-00	Operation/Stop (Function setting 46-00) or Forced stop (Function setting 46-02)	Forced thermostat Off
9	60-09		Forced thermostat Off
10	60-10		Forced thermostat Off
11	60-11		Forced thermostat Off
12	60-12		Forced thermostat Off

Mode	Function setting	External output			
		Indoor unit			
		CN20	CN21	CN22	CN23
0	60-00	Operation/Stop	Error status	Indoor unit fan operation status	External heater output
9	60-09	Error status	Operation/Stop	Indoor unit fan operation status	External heater output
10	60-10	Indoor unit fan operation status	Operation/Stop	Error status	External heater output
11	60-11	External heater output	Operation/Stop	Indoor unit fan operation status	Error status

NOTE: Input of Operation/Stop depends on the setting of function setting 46.

00: Operation/Stop mode 1 (Remote controller enabled)

01: (Setting prohibited)

02: Forced stop

03: Operation/Stop mode 2 (Remote controller disabled)

● Input signal type

• Indoor unit

Input signal type is only "Edge".

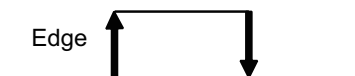

■ Details of function

● Control input function

- When function setting is "Operation/Stop" mode 1
 - In the case of "Edge" input

Mode	Function setting		External input	Input signal	Command	
0	46-00	—	Input of indoor unit	CN14	Off → On	Operation
					On → Off	Stop
	60-00	CN15		Off → On	Operation	
				On → Off	Stop	

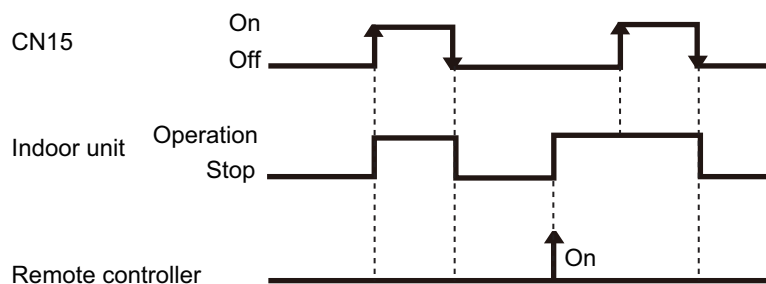

- When function setting is "Forced stop" mode
 - In the case of "Edge" input

Mode	Function setting		External input	Input signal	Command	
0	46-02	—	Input of indoor unit	CN14	Off → On	Forced stop
					On → Off	Normal
	60-00	CN15		Off → On	Forced stop	
				On → Off	Normal	

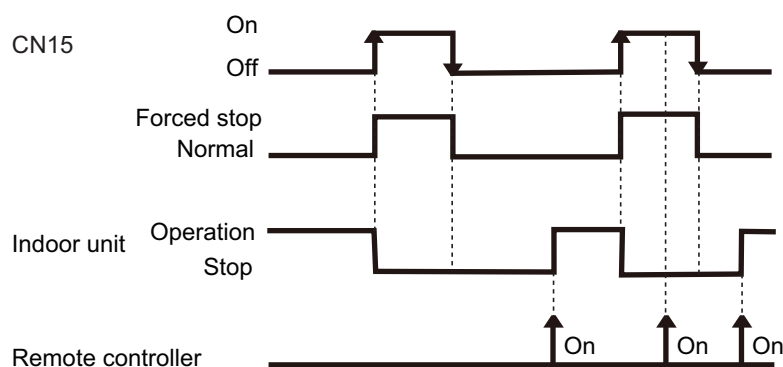

- When function setting is "Operation/Stop" mode 2
 - In the case of "Edge" input

Mode	Function setting		External input	Input signal	Command	
0	46-03	—	Input of indoor unit	CN14	Off → On	Operation
				CN14	On → Off	Stop (Remote controller disabled)
	60-00	CN15		Off → On	Operation	
		CN15		On → Off	Stop (Remote controller disabled)	

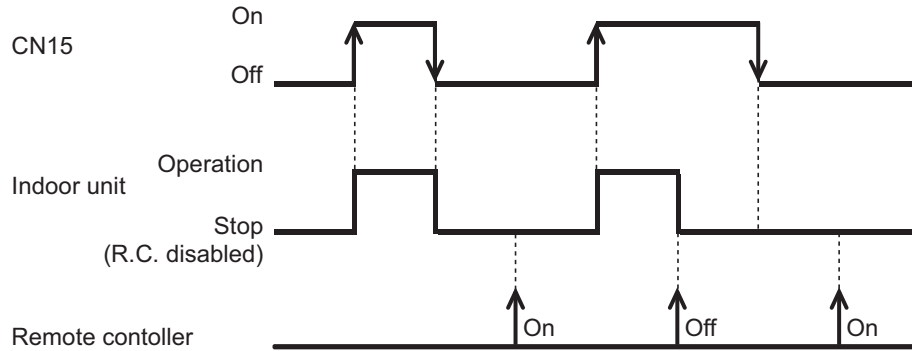

● Control output function

• Operation/Stop status

Mode	Function setting	External output		Output signal	Command
0	60-00	Output of indoor unit	CN15	Low → High	Operation
				High → Low	Stop
0	60-00		CN20	Off → On	Operation
				On → Off	Stop

The output is low when the unit is stopped.

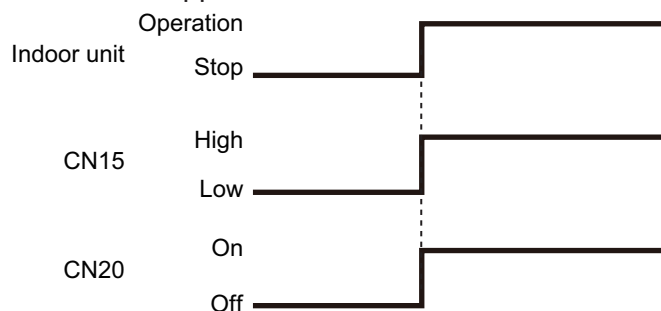

• Error status

Mode	Function setting	External output		Output signal	Command
9	60-09	Output of indoor unit	CN15	Low → High	Error
				High → Low	Normal
0	60-00		CN21	Off → On	Error
				On → Off	Normal

The output is ON when an error is generated for the indoor unit.

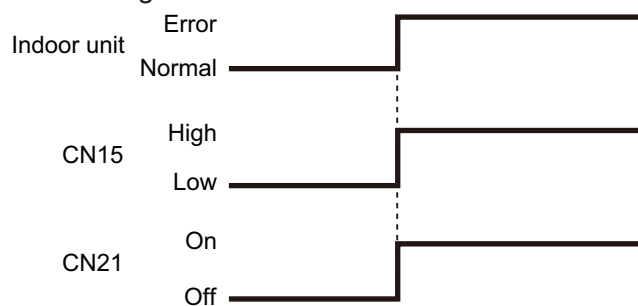

- Indoor unit fan operation status

Mode	Function setting	External output		Output signal	Command
10	60-10	Output of indoor unit	CN15	Low → High	Fan run
				High → Low	Fan stop
0	60-00	Output of indoor unit	CN22	Off → On	Fan run
				On → Off	Fan stop

Output signal	Condition
On Low → High	The indoor unit fan is operating.
Off High → Low	The fan is stopped or during cold air prevention. During thermostat off when in dry mode operation.

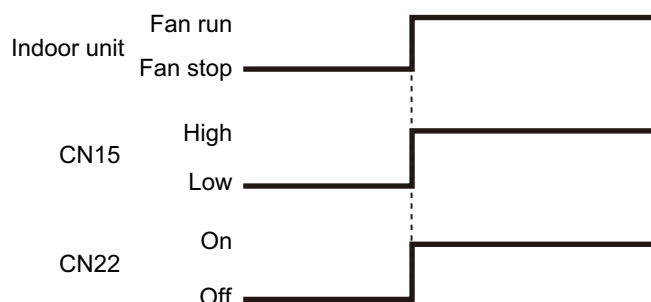

- Setpoint Attainment status

NOTE: This function is valid only when function setting 96 is set to “01” (Primary unit) or “02” (Secondary unit).

When the room temperature does not reach the setpoint at a room due to the lower cooling performance caused by external factor such as the outdoor temperature change, signal is output to tell the attainment status of setpoint.

Mode	Function setting	External output		Output signal	Command
12	60-12	Output of indoor unit	CN15	On → Off	Normal
				Off → On	Setpoint Attainment

Output signal	Condition
Off	Reached the setpoint. ($Tr \leq Tsa + 0.5^{\circ}C$)
On	Unreached the setpoint. ($Tr > Tsa + 2.5^{\circ}C$) However, even if the setpoint unreached, the signal will not be output for 7 minutes after power is turned on.

When performing the server room control, both of the primary unit and secondary unit output the setpoint attainment status if any of the unit is outputting alternative operation command.

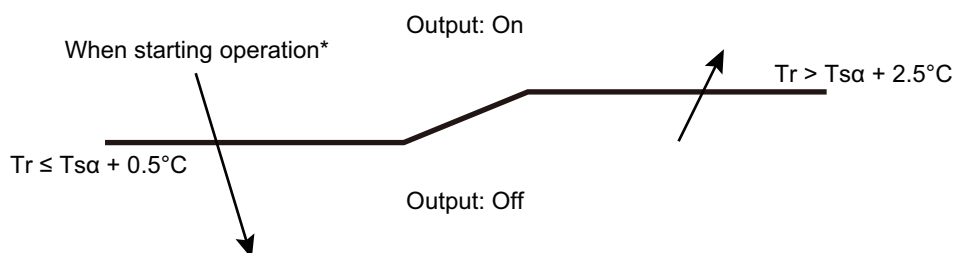

*: When starting operation or resetting, judges the zone to descending direction.

● External heater output

• Installation configuration of individual connection

External heating device is installed individually. (No use of indoor unit fan)

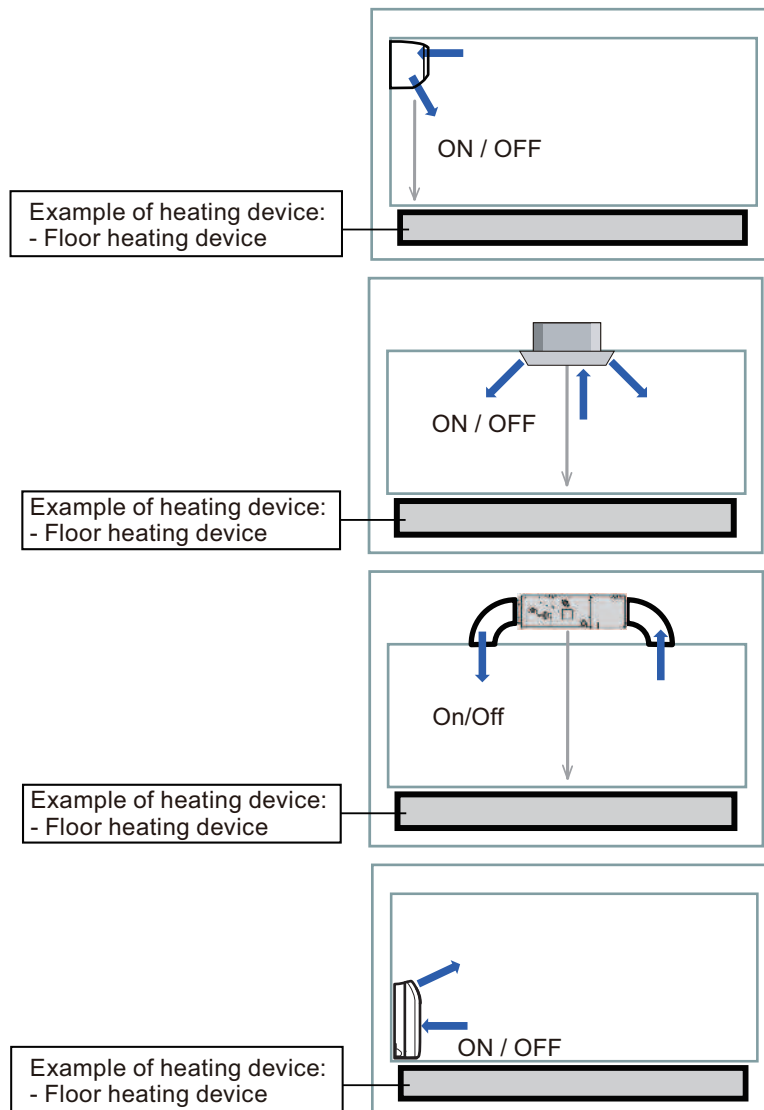

⚠ WARNING

- Design and install external heater appropriately with considering its protection.
- Inappropriate designing and installation of external heater may cause a fire by emitted heat from the external heater.
- Fujitsu General Ltd. is not responsible for inappropriate designing or installation of external heating device.

• Auxiliary heater control 1

Operation	Condition
Heater on	Heater is on as shown in following diagram of heating temperature.
Heater off	<ul style="list-style-type: none"> • Heater is off as shown in following diagram of heating temperature. • Other than heating mode • Error occurred • Forced thermostat off • Fan stop protection

- Temperature of heater on (Thon): Adjustable by function number 62 (Operating temperature switching of external heaters).
- All control temperatures will shift by adjusting "Thon".

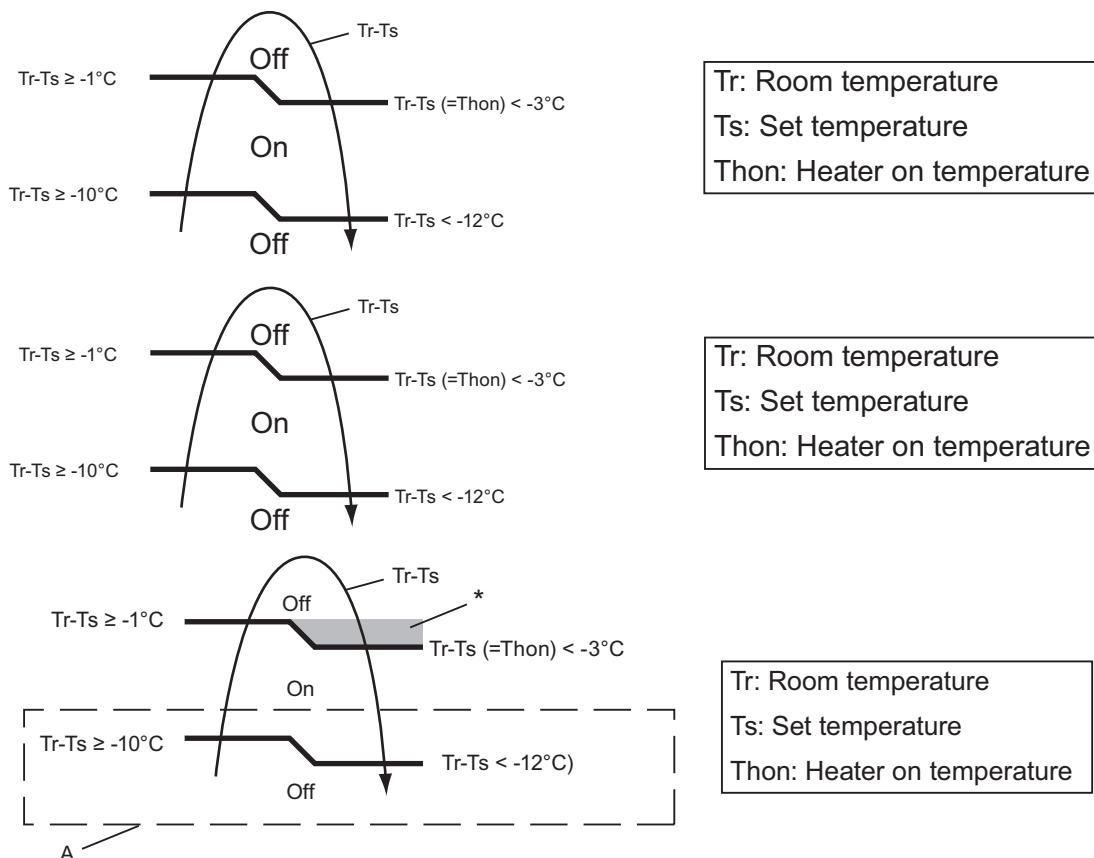

*: When room temperature stays in this zone for a specific time, auxiliary heater is turned on. For details, refer to function number 71.

Example: When set temperature (Ts) is 22°C (Factory setting),

- and room temperature (Tr) increases above 12°C, signal output is on.
- and room temperature (Tr) increases above 21°C, signal output is off.
- and room temperature (Tr) decreases below 19°C, signal output is on.
- and room temperature (Tr) decreases below 10°C, signal output is off.

13. Group connection

NOTE: Group control cannot be used together with WLAN Adapter.

Installation procedure for group control system:

A number of indoor units can be operated at the same time using a single remote controller.

NOTE: When different type of indoor units (such as wall mounted type and cassette type, cassette type and duct type, or other combinations) are connected using group control system, some functions may no longer be available.

1. Connect up to 16 indoor units in a system.

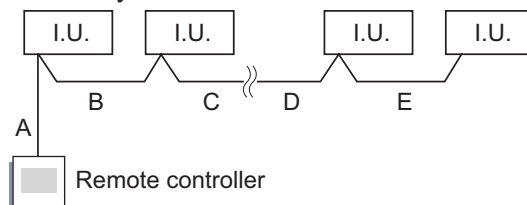

A, B, C, D, E: Remote controller cable	
Wiring length limitation	$A + B + C + D + E \leq 500 \text{ m}$

Example of wiring method

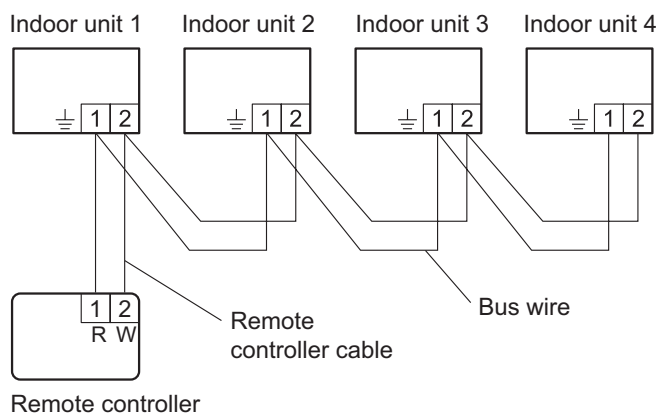

Example of wiring method

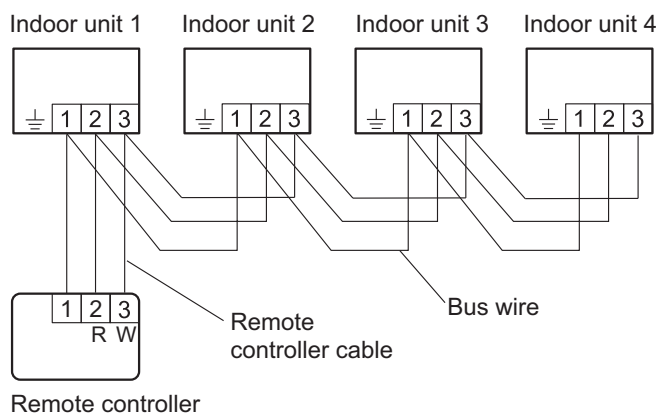

14. Remote controller

14-1. Wireless remote controller (AR-REW4E and AR-REJ1E)

Overview

AR-REW4E

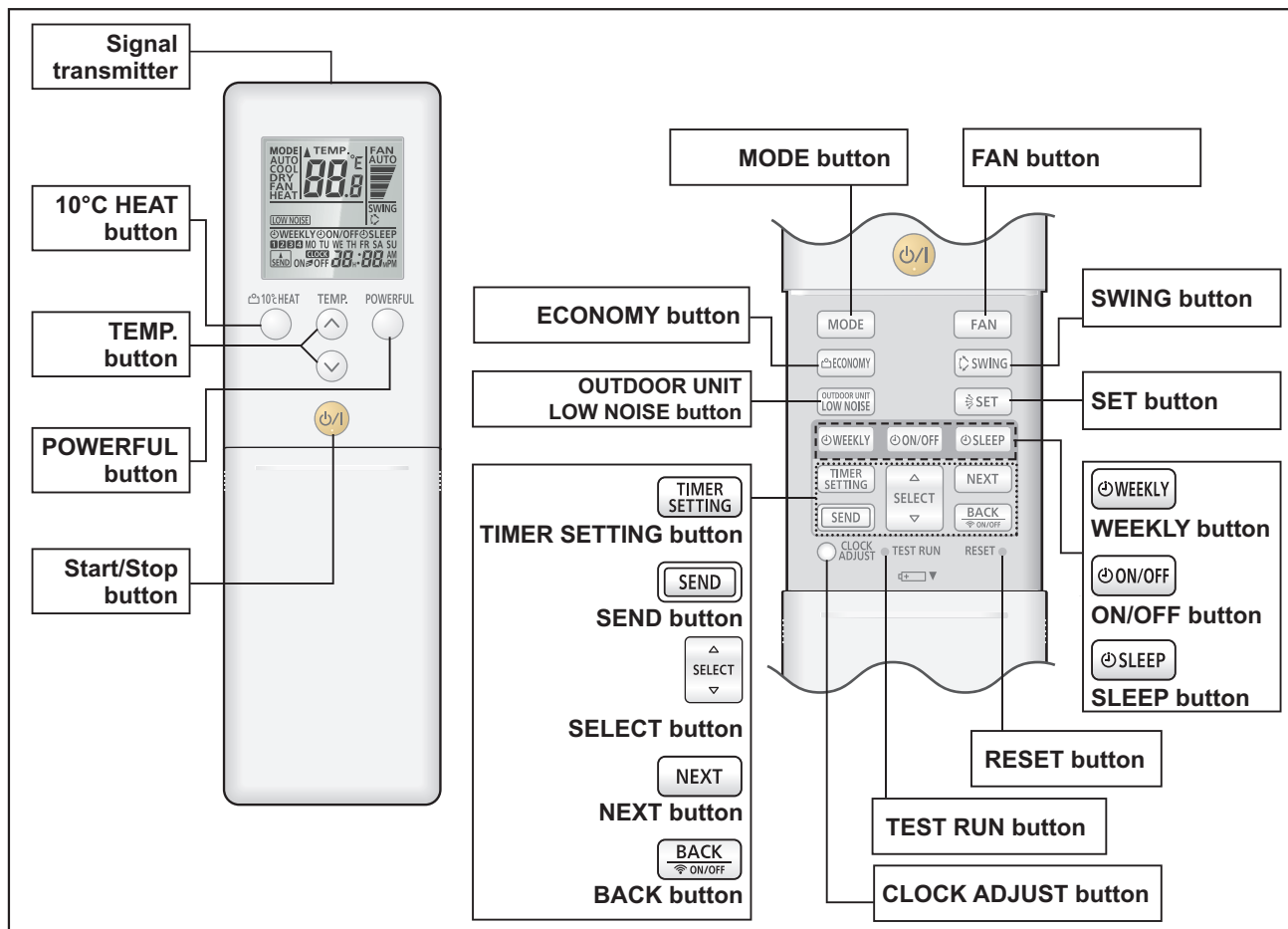

NOTE: Functions may differ by type of the indoor unit. For details, refer to the operation manual.

Display panel

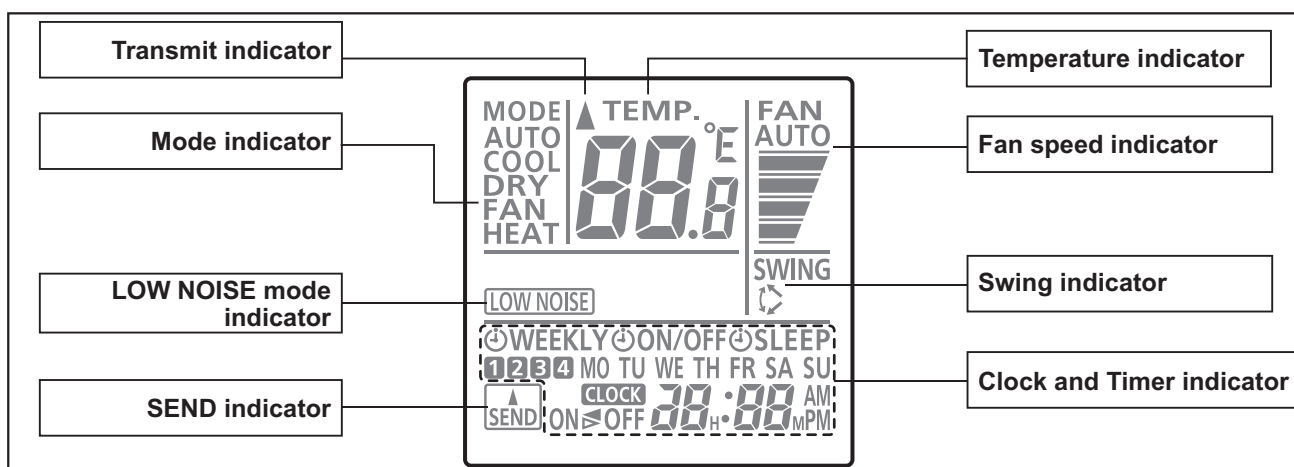

To facilitate explanation, the accompanying illustration has been drawn to show all possible indicators; in actual operation, however, the display will only show those indicators appropriate to the current operation.

AR-REJ1E

2-UNIT
MULTI-SPLIT TYPE

2-UNIT
MULTI-SPLIT TYPE

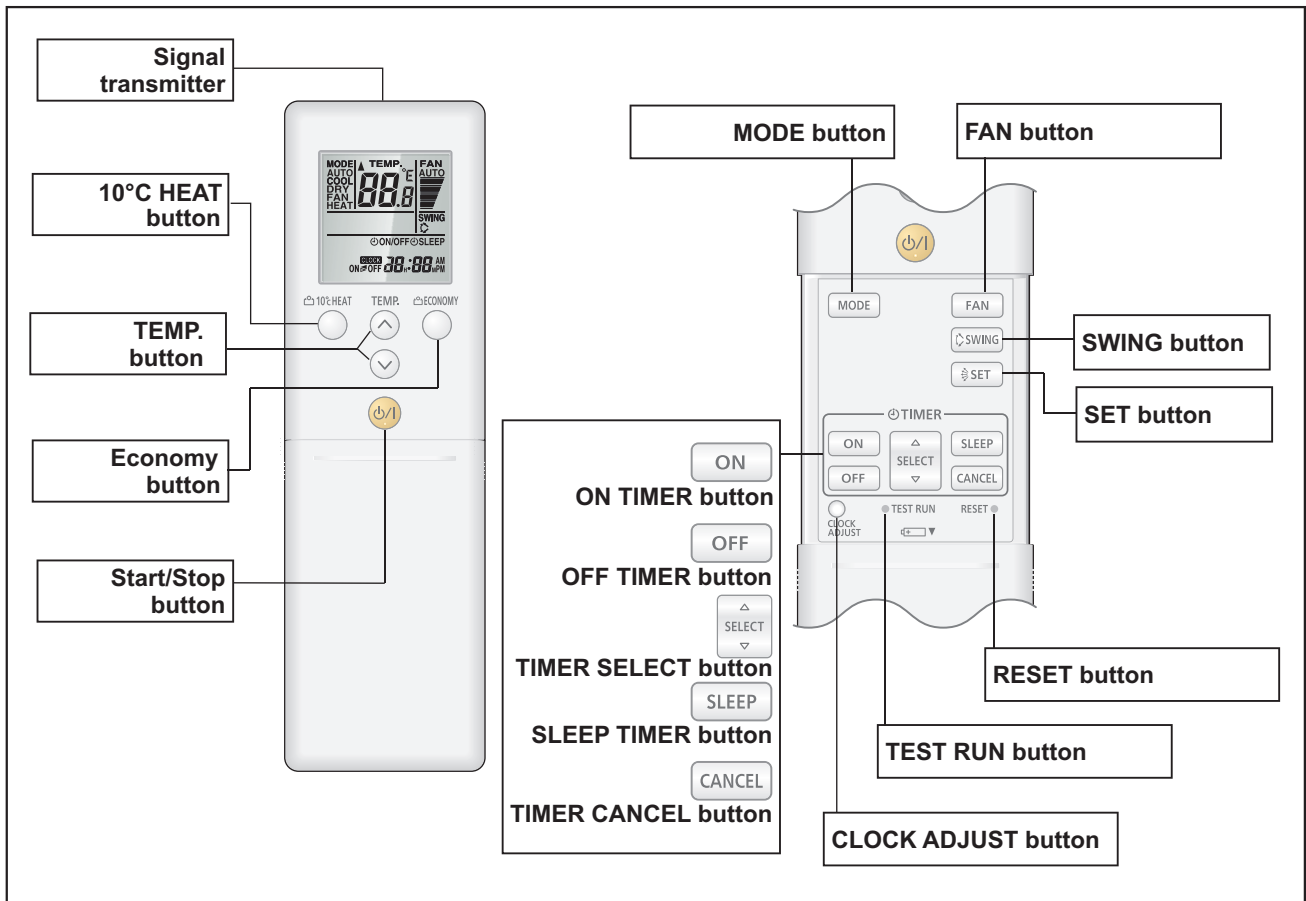

NOTE: Functions may differ by type of the indoor unit. For details, refer to the operation manual.

Display panel

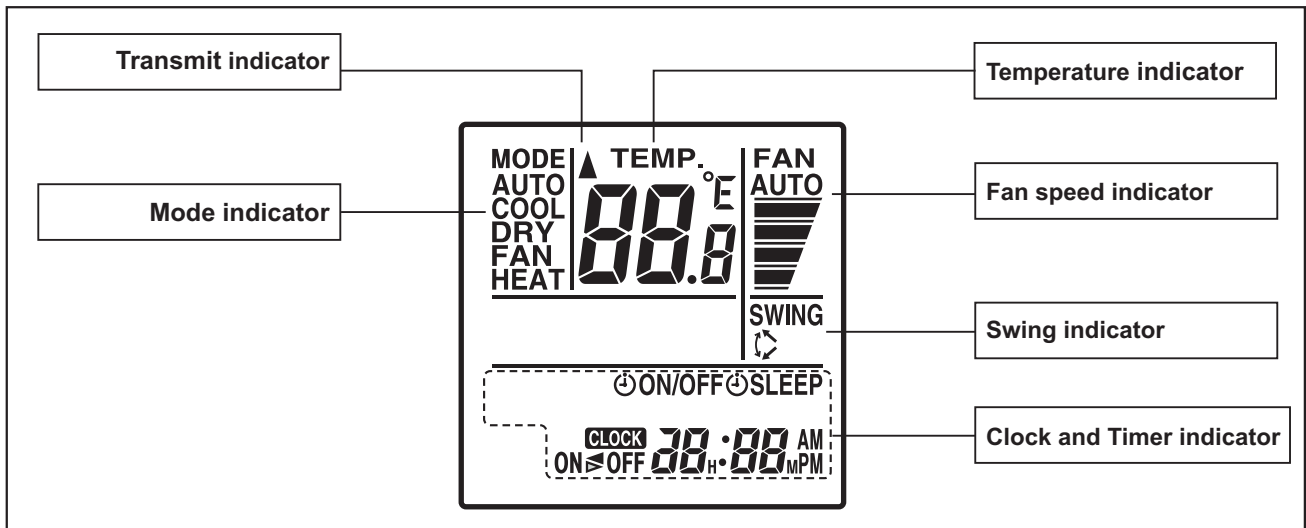

To facilitate explanation, the accompanying illustration has been drawn to show all possible indicators; in actual operation, however, the display will only show those indicators appropriate to the current operation.

■ Specifications

● Controller

Unit: mm

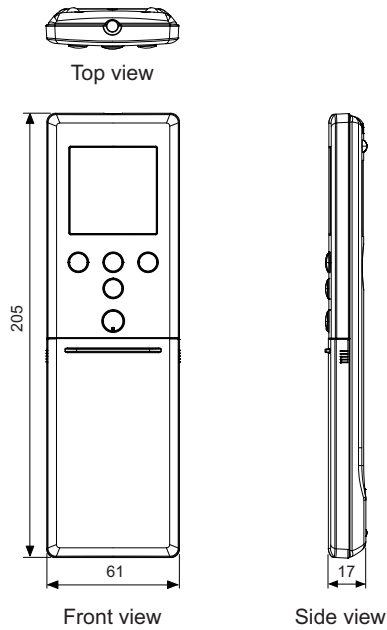

Size (H × W × D)	mm	205 × 61 × 17
Weight	g	124 (without batteries)

● Holder

Unit: mm

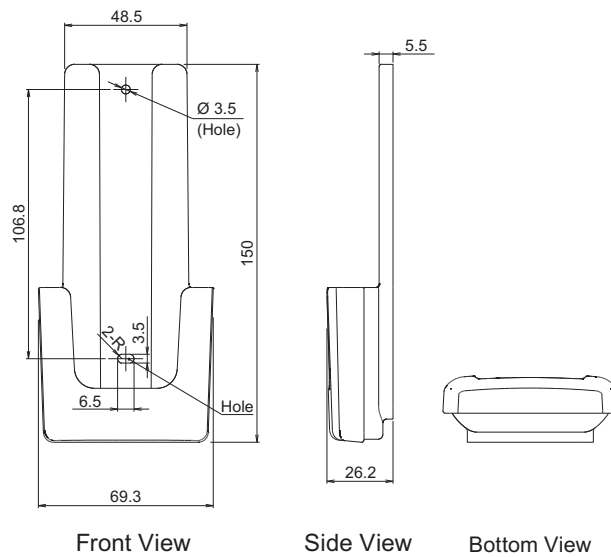

Size (H × W × D)	mm	150 × 69.3 × 26.2
Weight	g	27

14-2. Wireless remote controller (AR-REW3E)

Overview

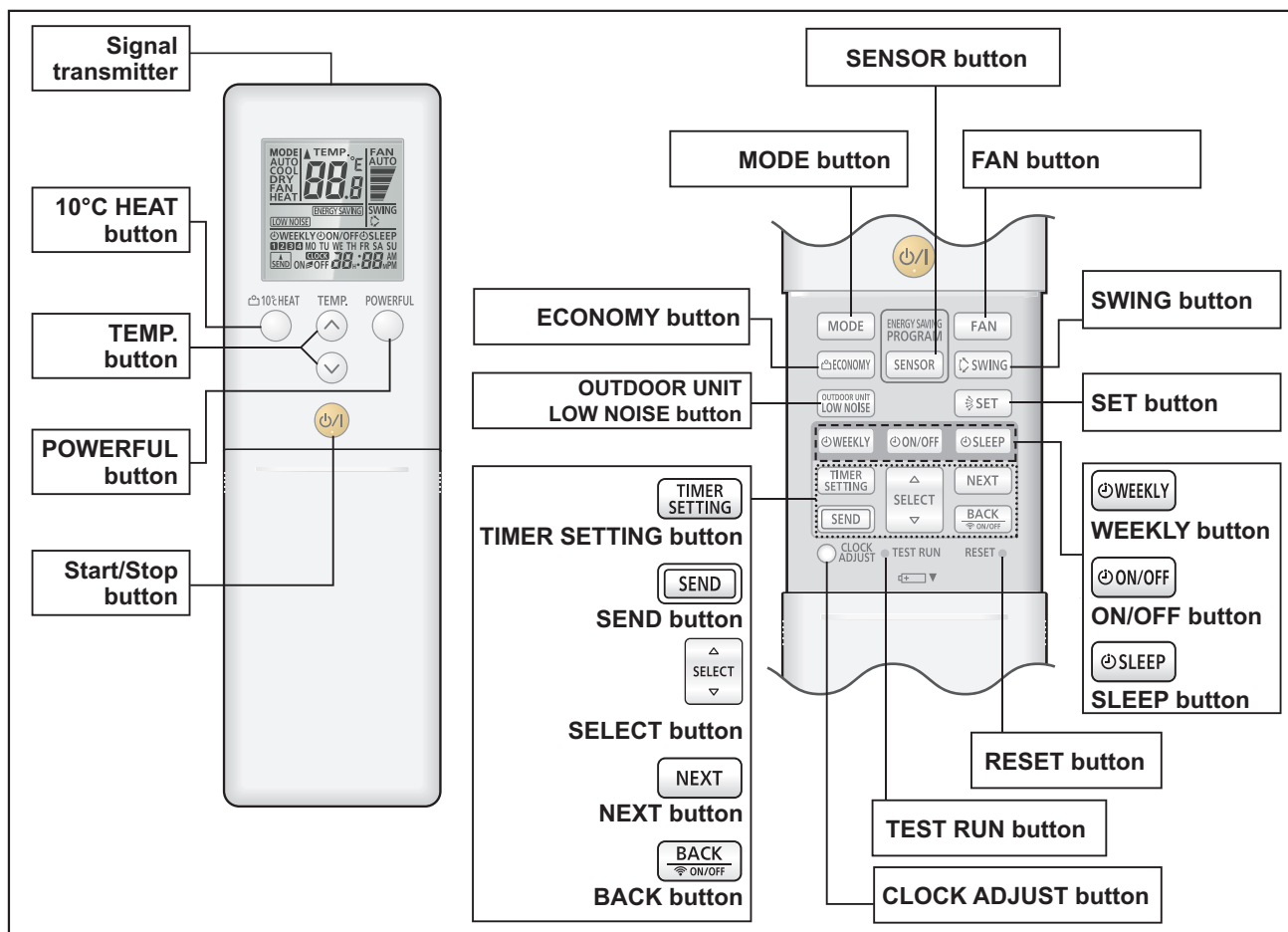

NOTE: Functions may differ by type of the indoor unit. For details, refer to the operation manual.
Display panel

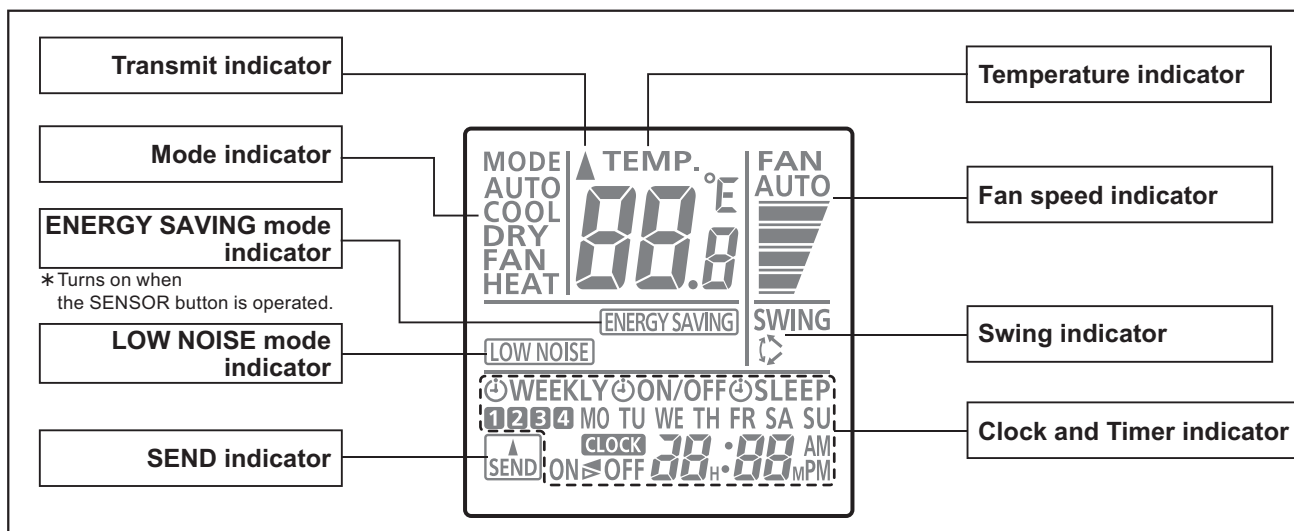

To facilitate explanation, the accompanying illustration has been drawn to show all possible indicators; in actual operation, however, the display will only show those indicators appropriate to the current operation.

Specifications

● Controller

Unit: mm

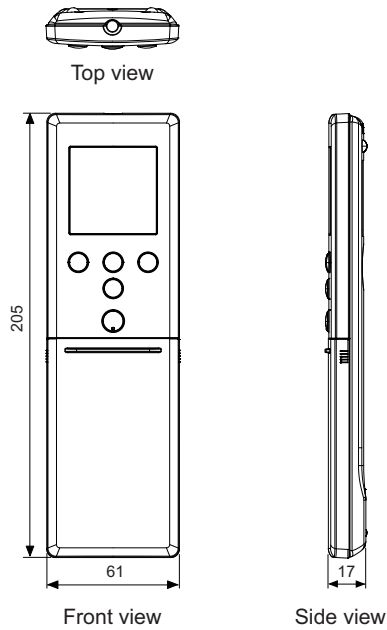

Size (H × W × D)	mm	205 × 61 × 17
Weight	g	124 (without batteries)

● Holder

Unit: mm

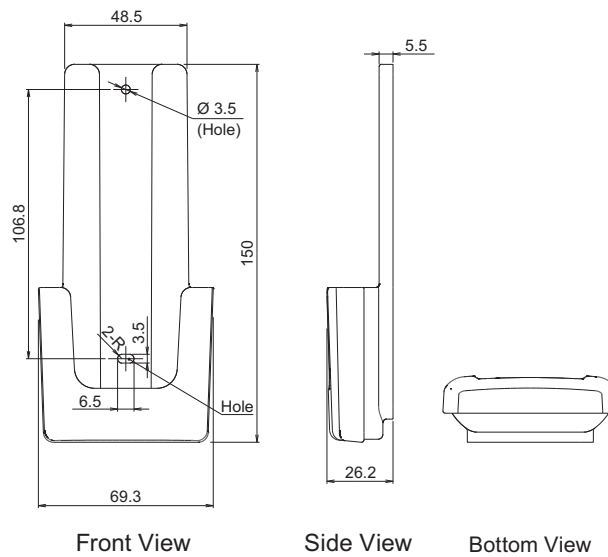

Size (H × W × D)	mm	150 × 69.3 × 26.2
Weight	g	27

14-3. Wireless remote controller (AR-REM7E)

Overview

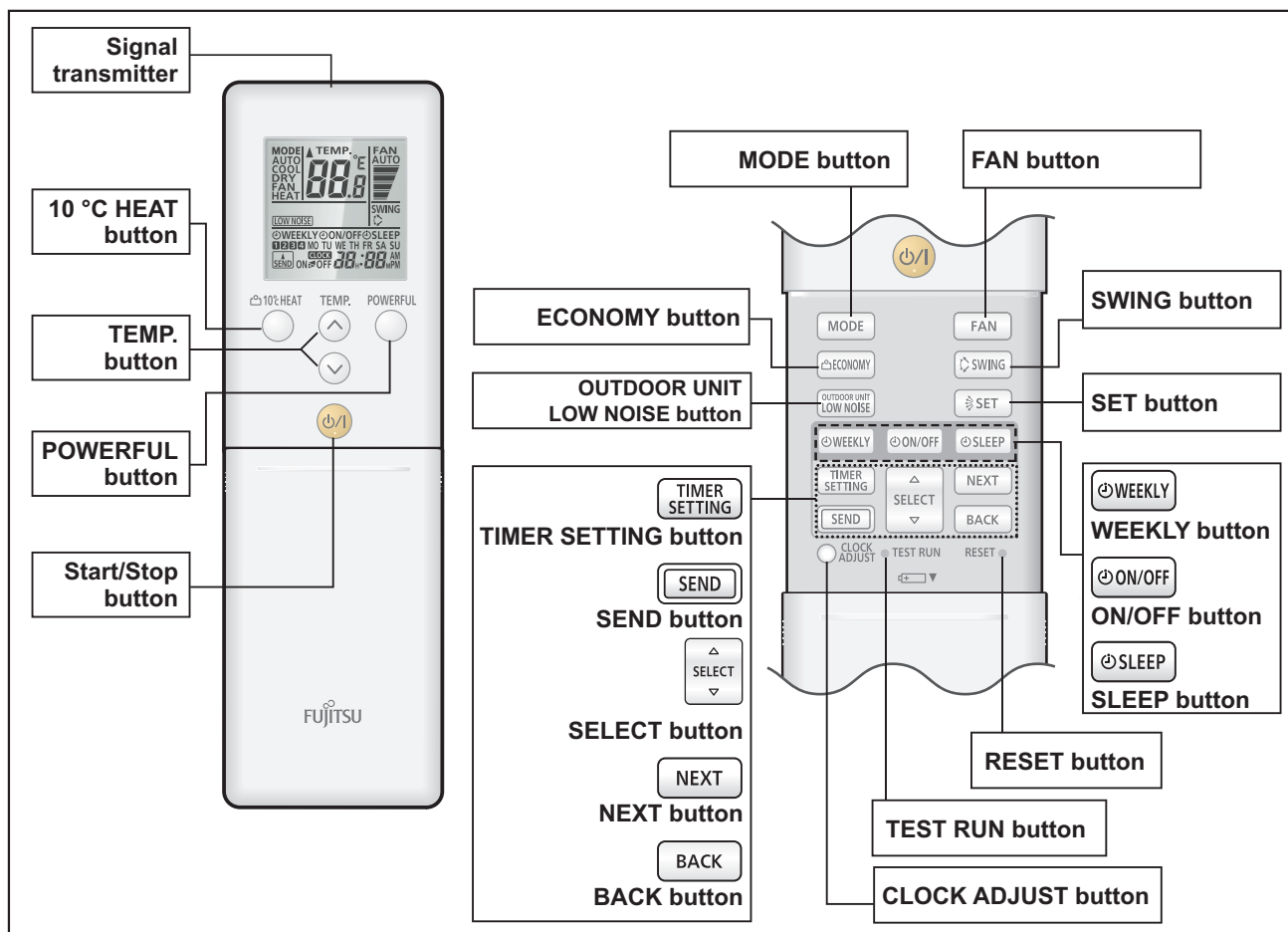

NOTE: Functions may differ by type of the indoor unit. For details, refer to the operation manual.
Display panel

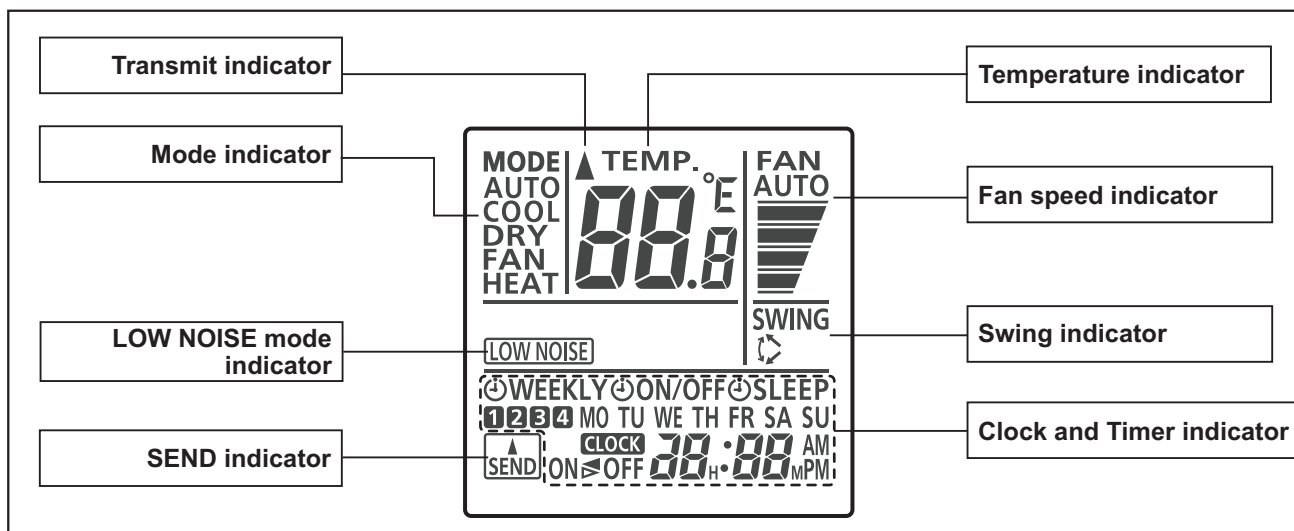

To facilitate explanation, the accompanying illustration has been drawn to show all possible indicators; in actual operation, however, the display will only show those indicators appropriate to the current operation.

Specifications

● Controller

Unit: mm

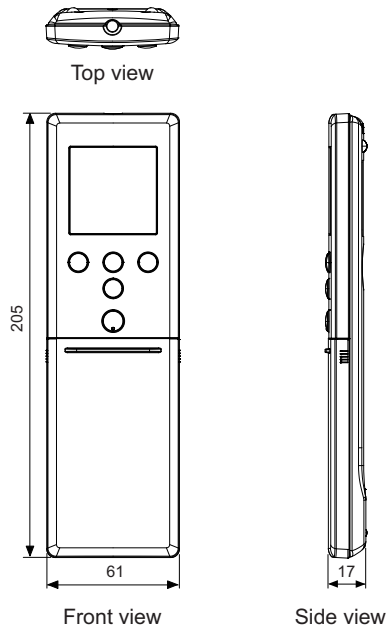

Size (H × W × D)	mm	205 × 61 × 17
Weight	g	124 (without batteries)

● Holder

Unit: mm

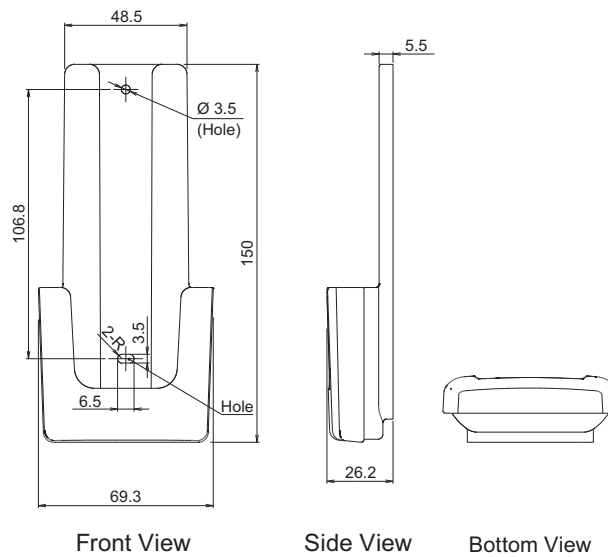

Size (H × W × D)	mm	150 × 69.3 × 26.2
Weight	g	27

14-4. Wireless remote controller (AR-RMB1E and AR-RMB1E-B)

Overview

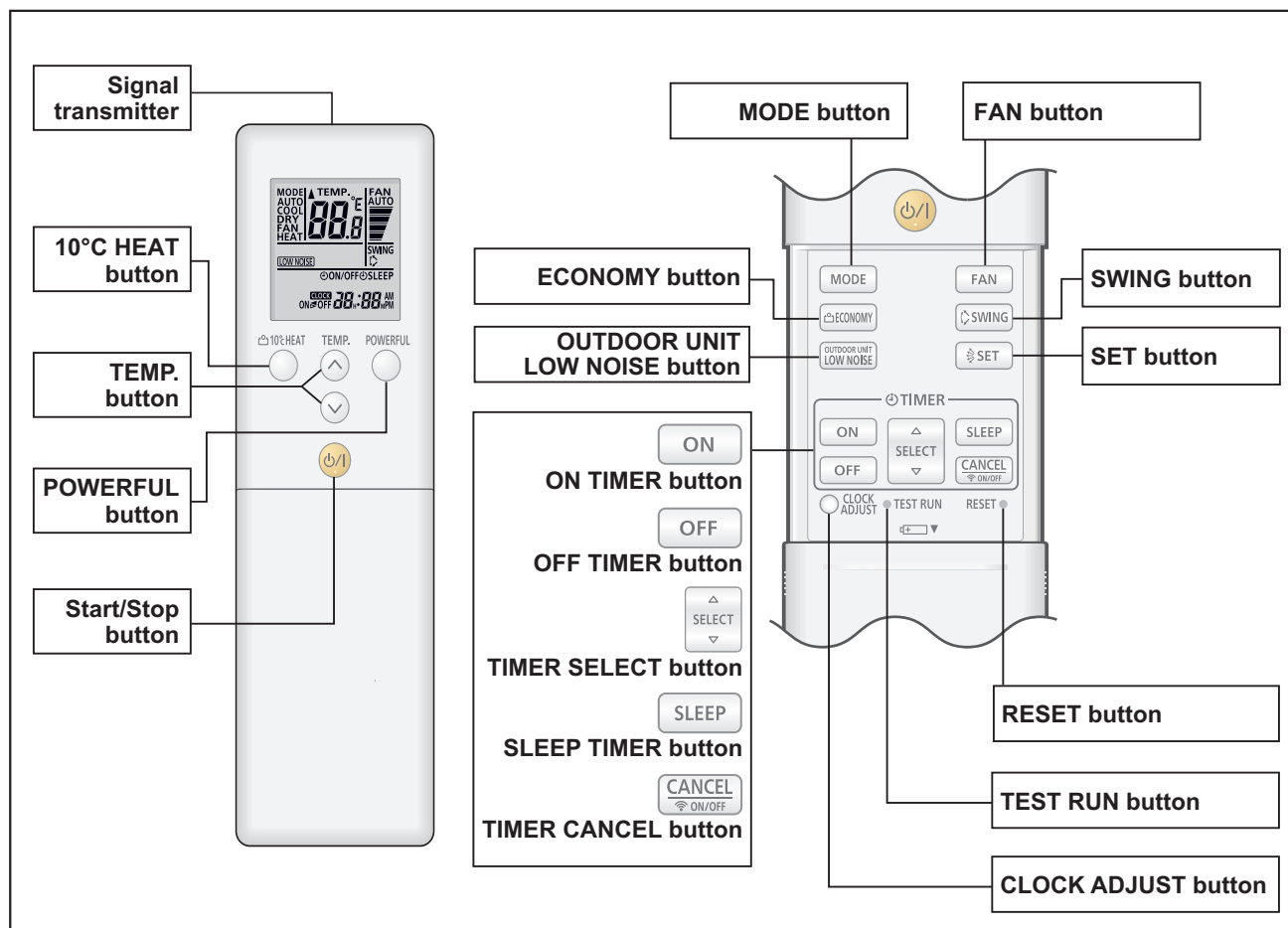

NOTE: Functions may differ by type of the indoor unit. For details, refer to the operation manual.
Display panel

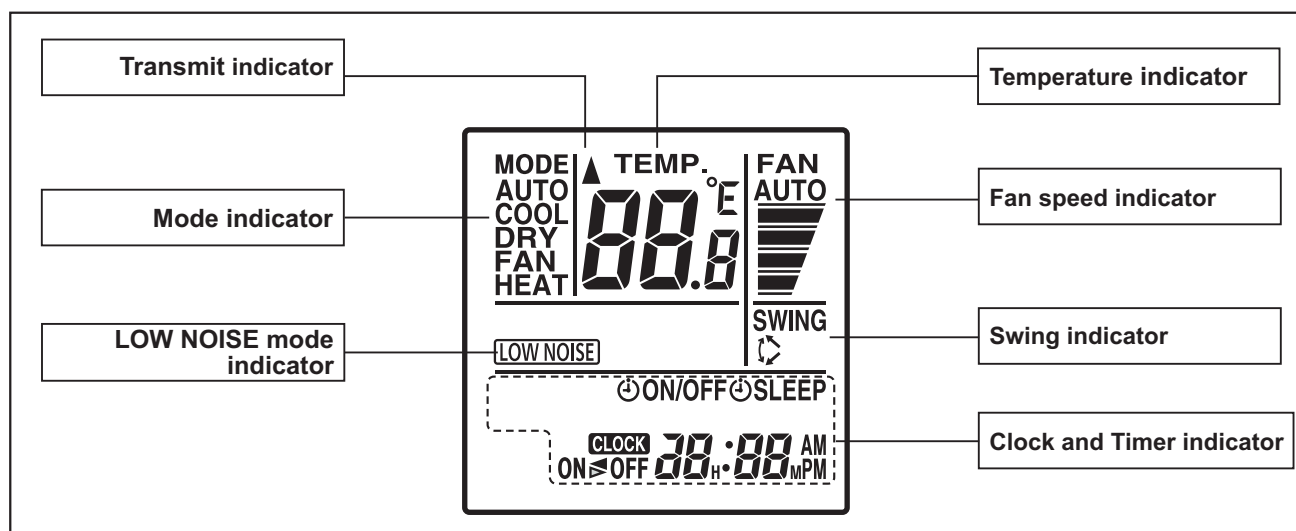

To facilitate explanation, the accompanying illustration has been drawn to show all possible indicators; in actual operation, however, the display will only show those indicators appropriate to the current operation.

Specifications

● Controller

Unit: mm

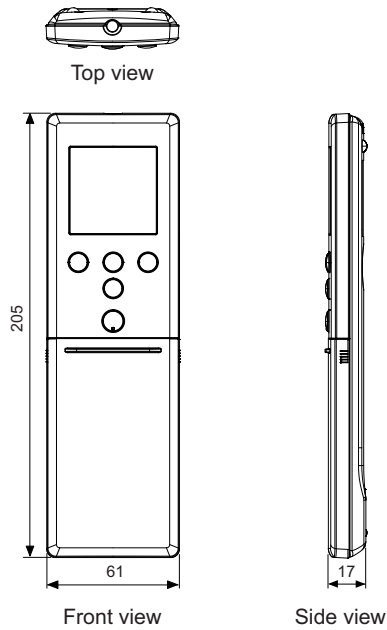

Size (H × W × D)	mm	205 × 61 × 17
Weight	g	124 (without batteries)

● Holder

Unit: mm

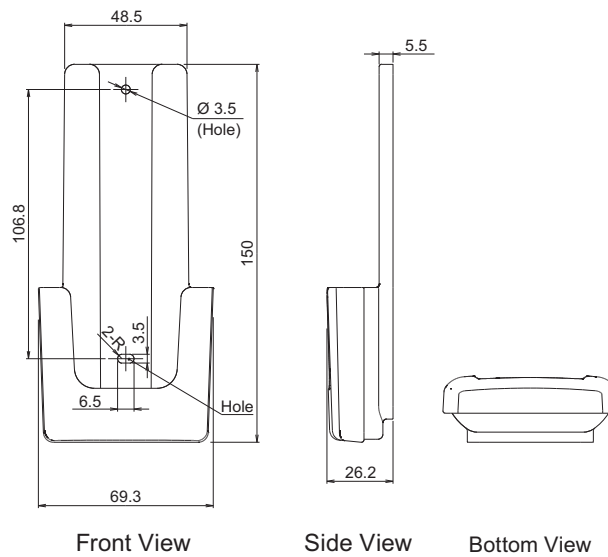

Size (H × W × D)	mm	150 × 69.3 × 26.2
Weight	g	27

14-5. Wireless remote controller (UTY-LNTY: Optional part) and IR receiver kit with Wireless remote controller (UTY-LBTYM: Optional part)

Overview

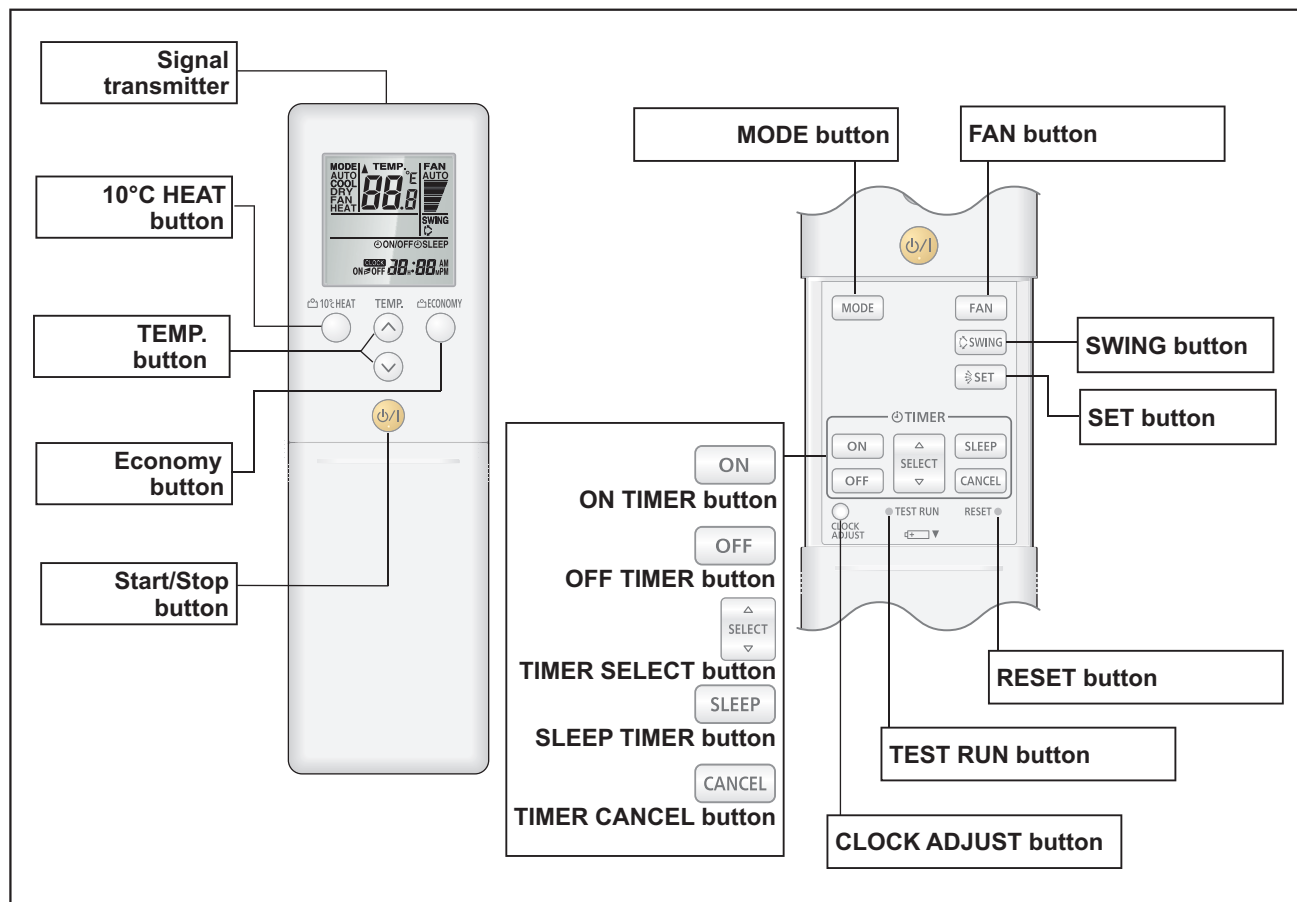

NOTE: Functions may differ by type of the indoor unit. For details, refer to the operation manual.

Display panel

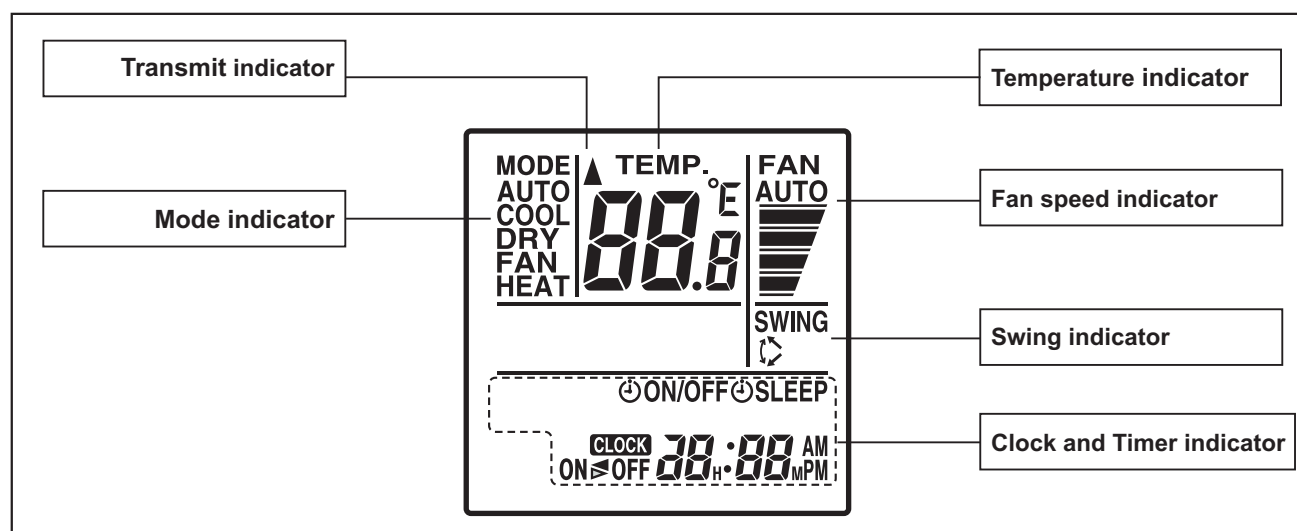

To facilitate explanation, the accompanying illustration has been drawn to show all possible indicators; in actual operation, however, the display will only show those indicators appropriate to the current operation.

Specifications

● Controller

Unit: mm

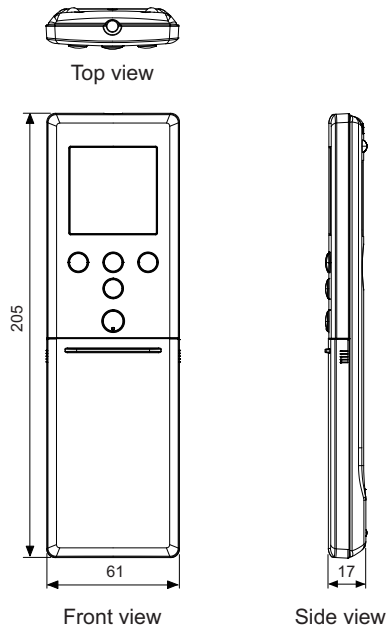

Size (H × W × D)	mm	205 × 61 × 17
Weight	g	124 (without batteries)

● Holder

Unit: mm

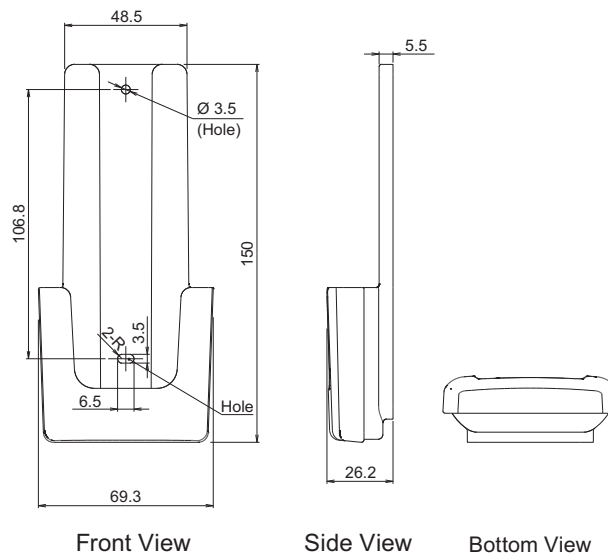

Size (H × W × D)	mm	150 × 69.3 × 26.2
Weight	g	27

● IR receiver (UTY-LBTYM)

Unit: mm

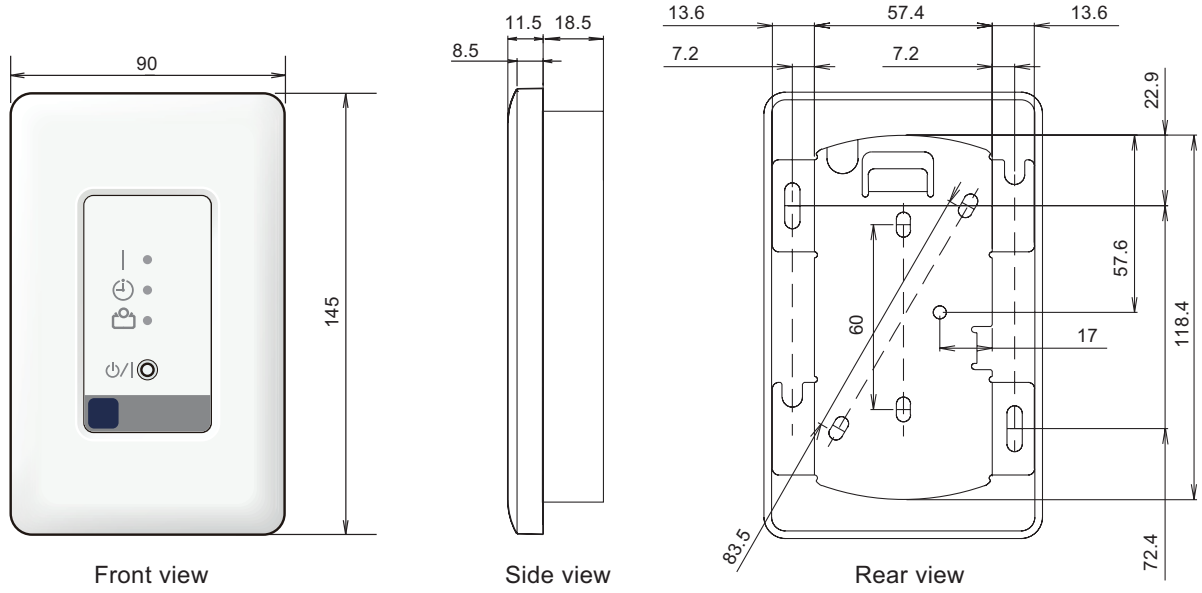

Size (H × W × D)	mm	145 × 90 × 30
Weight	g	150

14-6. Wireless remote controller (AR-RPF4E)

Overview

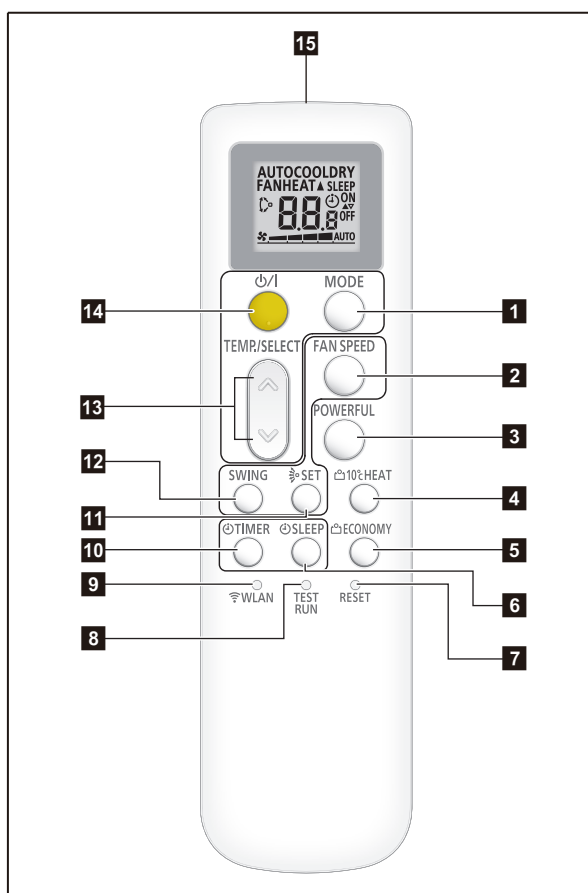

1 MODE button

- Switches operation mode (AUTO, COOL, DRY, FAN, and HEAT).
- Starts/ends the remote controller custom code (max. 4 types) change.

2 FAN SPEED button

- Press the FAN SPEED button while the air conditioner is operating, to control fan speed.

3 POWERFUL button

4 10 °C HEAT button

5 ECONOMY button

6 SLEEP TIMER button

7 RESET button

8 TEST RUN button

- Used only when installing the air conditioner, and should not be used under normal conditions, as it will cause the indoor unit's thermostat malfunction.
- If this button is pressed during normal operation, the indoor unit will switch to test operation mode, and the operation indicator lamp and the timer indicator lamp on the indoor unit will begin to flash simultaneously.
- To stop the test operation mode, press the START/STOP button. Then, the air conditioner stops the operation.

NOTE: If the service check mode starts unintentionally and “- -” appears on the remote controller display, press the START/STOP button to end this operation.

Display panel

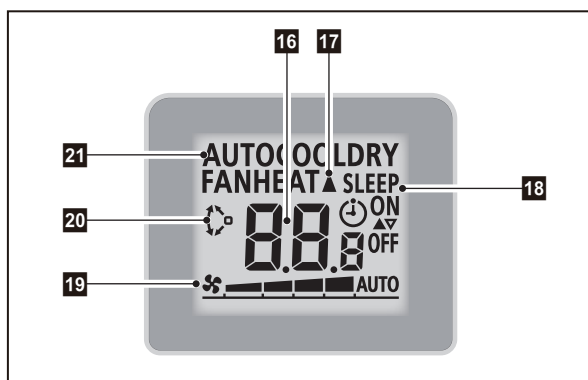

9 WLAN button

- Starts the wireless LAN setting.

10 TIMER button

11 SET button (Up/down airflow)

12 SWING button

13 TEMP./SELECT button

- Adjusts the setting temperature.
- Adjusts the value of the timer settings.
- Sets the remote controller code.

14 START/STOP button

15 Signal transmitter

16 Temperature and time indicator

- Displays set temperature.
- In timer setting, it displays the timer time. After finishing the timer setting, set temperature will reappear.

17 Signal transmit indicator

18 Timer mode indicator

19 Fan speed indicator

20 Swing indicator

21 Operating mode indicator

NOTES:

- Functions may differ by type of the indoor unit. For details, refer to the operation manual.
- This figure depicts all indicators that the remote controller can display on the screen for the functional explanation. In actual operation, the remote controller shows only the indicators that are appropriate for the current process.

■ Specifications

● Controller

Unit: mm

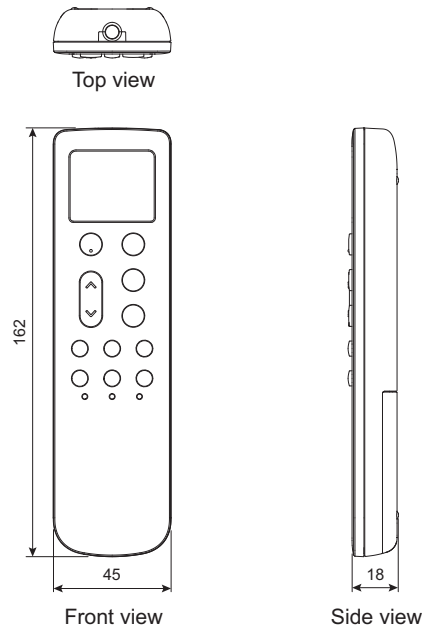

Size (H × W × D)	mm	162 × 45 × 18
Weight	g	65.5 (without batteries)

● Holder

Unit: mm

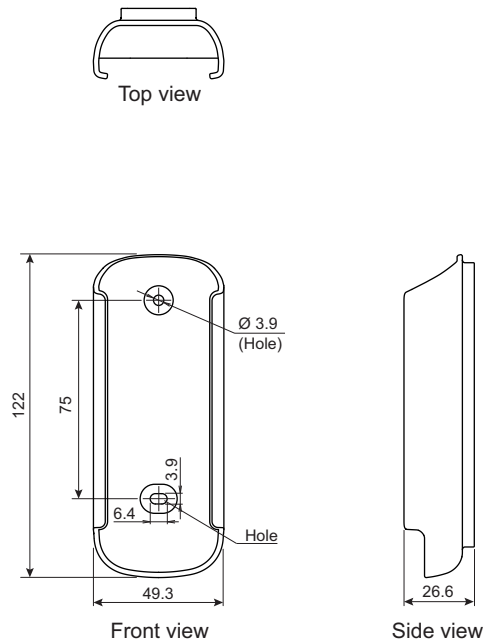

Size (H × W × D)	mm	122 × 49.3 × 26.6
Weight	g	23.5

14-7. Wired remote controller (UTY-RNNYM: Optional part)



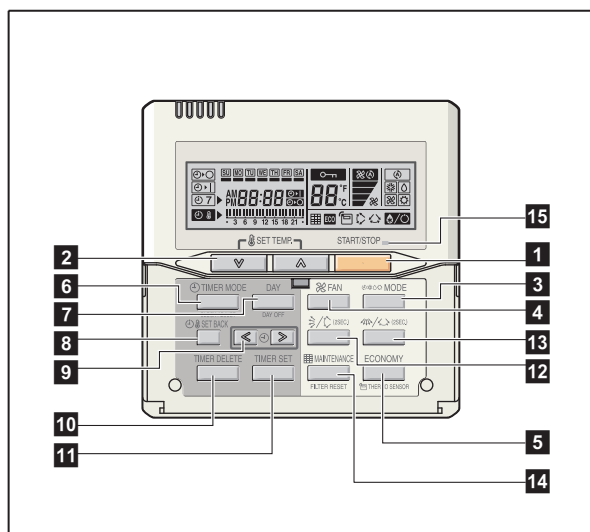



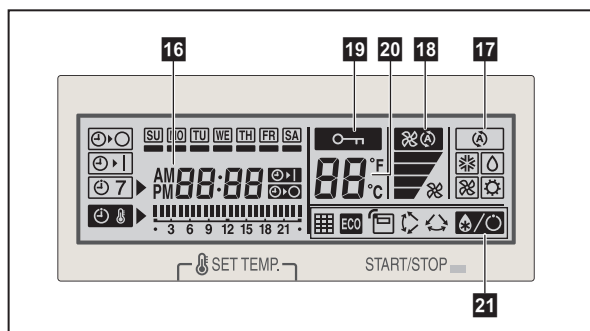









Overview



Display panel



NOTE: Functions may differ by type of the indoor unit. For details, refer to the operation manual.

- 1 START/STOP button**
Starts and stops operation.
- 2 SET TEMP. button**
Selects the setting temperature.
- 3 MODE button**
Selects the operating mode (AUTO , HEAT , FAN , COOL , and DRY ).
- 4 FAN button**
Selects the fan speed AUTO , QUIET , LOW , MED , and HIGH .
- 5 ECONOMY (THERMO SENSOR) button**
Turns the economy-efficient mode on and off.
- 6 TIMER MODE (CLOCK ADJUST) button**
Selects the timer mode (off timer, on timer, and weekly timer). Sets the current time.
- 7 DAY (DAY OFF) button**
Temporarily cancels one day timer.
- 8 SET BACK button**
Selects the set back timer.
- 9 Set time button**
Pressed to set time.
- 10 TIMER DELETE button**
Deletes the weekly timer schedule.
- 11 TIMER SET button**
Sets the date, hour, minute, and on-off time.
- 12 Vertical airflow direction and swing button**
Push for 2 seconds to change the swing mode.
- 13 Horizontal airflow direction and swing button**
Push for 2 seconds to change the swing mode.
- 14 FILTER RESET button**
- 15 Operation lamp**
Lights during operation and when the timer is on.
- 16 Timer and clock indicator**
- 17 Operation mode indicator**
- 18 Fan speed indicator**
- 19 Operation lock indicator**
- 20 Temperature indicator**
- 21 Function indicators**
 -  Defrost indicator
 -  Thermo sensor indicator
 -  Economy indicator
 -  Vertical swing indicator
 -  Horizontal swing indicator
 -  Filter indicator

System diagram

1 remote controller:

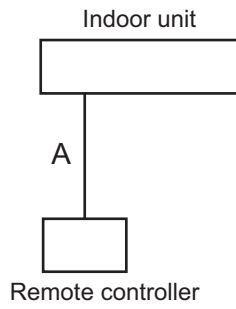

2 remote controllers:

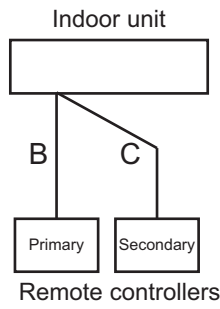

A, B, C: Remote controller cable
 $A \leq 500 \text{ m}; B + C \leq 500 \text{ m}$

Electrical wiring

1 remote controller:

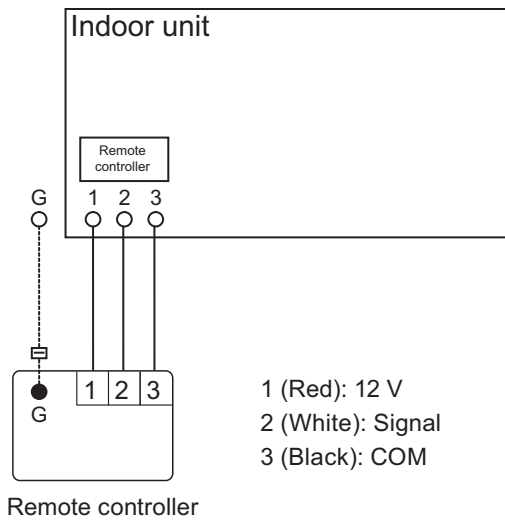

2 remote controllers:

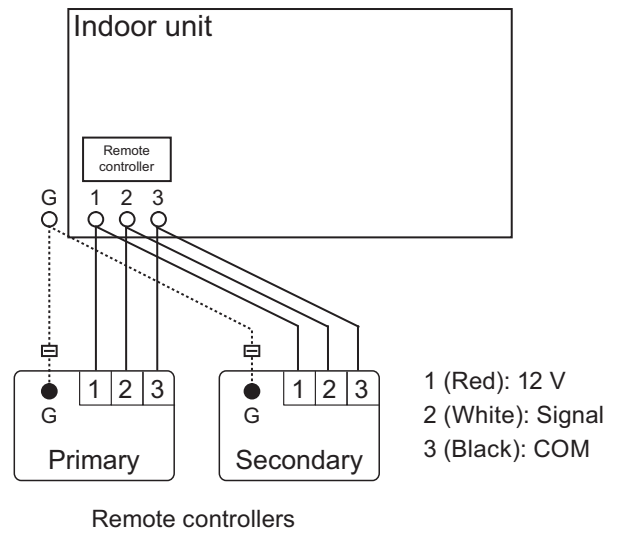

■ Specifications

Dimensions and other specifications on the wired remote controller are as follows.

		Unit: mm
<div style="display: flex; justify-content: space-around;"> Front view Side view </div>		
Size (H × W × D)	mm	120 × 120 × 18
Weight	g	160
Cable length (accessory)	m	10
Power	V	12

● Wiring specifications

Use	Cable size	Wire type	Remarks
Remote controller cable	0.33 mm ² (22 AWG)	Polar 3-core	Use sheathed PVC cable.

■ Installation

Connection pattern of wired remote controller varies by the type of the connected indoor unit.

● When connecting to terminal block (for Compact cassette, Slim duct, and Mini duct types)

Connect the end of remote controller cable directly to the exclusive terminal block.

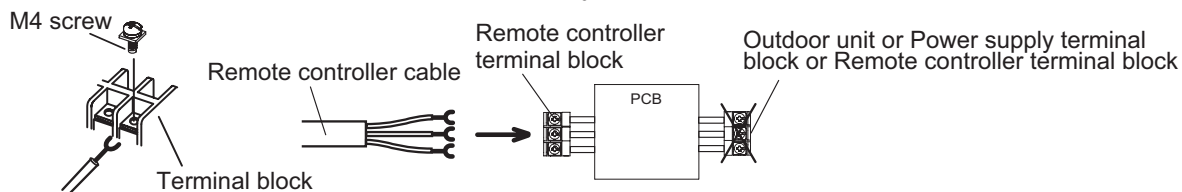

NOTE: It may be failed if it is connected to the outdoor unit or the terminal block for power supply.

14-8. Wired Remote Controller (UTY-RVRY : Optional part)



- Easy finger touch operation with LCD panel.
- Screen with anti-fingerprint coating
- Various information display (Room temp., Operation mode, Set temp. Fan speed, Timer)
- Control up to 16 indoor units
- Corresponds to 3 different languages (English, French, Spanish)

■ Overview

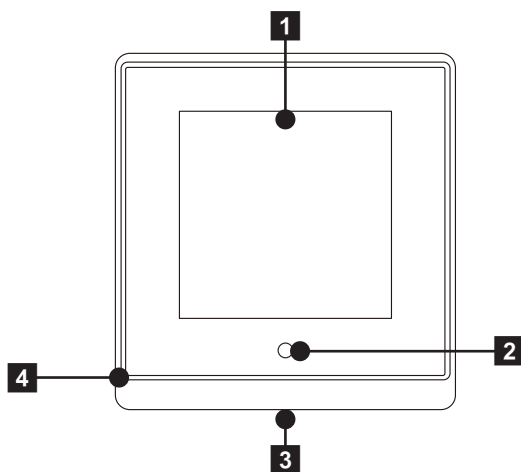

1 Touch screen

It can be operated by tapping or swiping.

NOTE: Operate with your finger or stylus pen (not included). Do not touch the screen with a hard or sharp object as it may cause a malfunction.

2 Ambient light sensor

Detects the brightness around the controller.

3 Operation lamp

Lights while the indoor units is operating. Blinks when an error occurs.

4 Remote temperature sensor (inside)

Detects the temperature around the controller.

Temperature setting screen

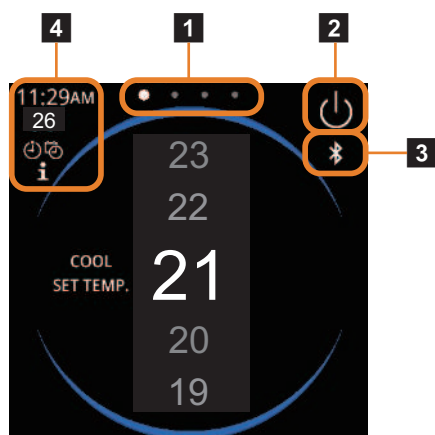

1 Page indicator

Shows the order of pages and displayed page.

2 Operation On/Off button

Tap to start operation or stop the air conditioner.

3 Bluetooth icon

Displays when Bluetooth is enabled.

4 Information area

The displayed contents differ depending on the screen and settings.

Operation mode setting screen

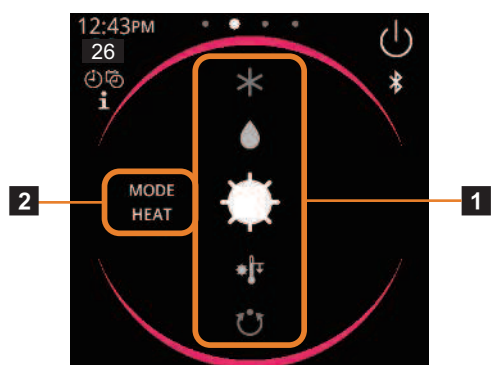

1 Operation mode setting area

Swipe up or down to select the operation mode.

2 Operation mode

The operation mode of the air conditioner is displayed.

Fan speed setting screen

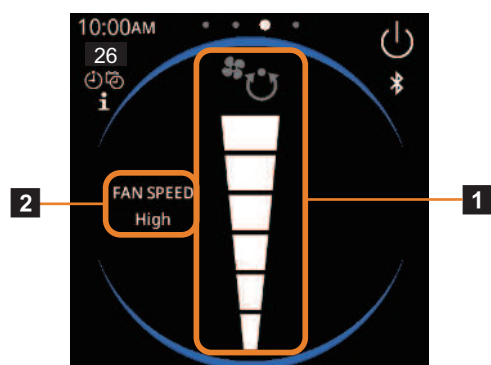

1 Fan speed setting area

Swipe up or down to set the fan speed.

is AUTO.

2 Fan speed

Displays the set fan speed.

Other setting screen



1 WEEKLY TIMER

2 DETAIL

For details of the settings, refer to the *OPERATION MANUAL* for this product.

3 SETTINGS

For details of the settings, refer to the *OPERATION MANUAL* for this product.

NOTE: To display settings screen, it is necessary to enter the admin password.

■ System diagrams

• Multiple remote control

Up to 3 remote controllers can be used to operate the indoor units.

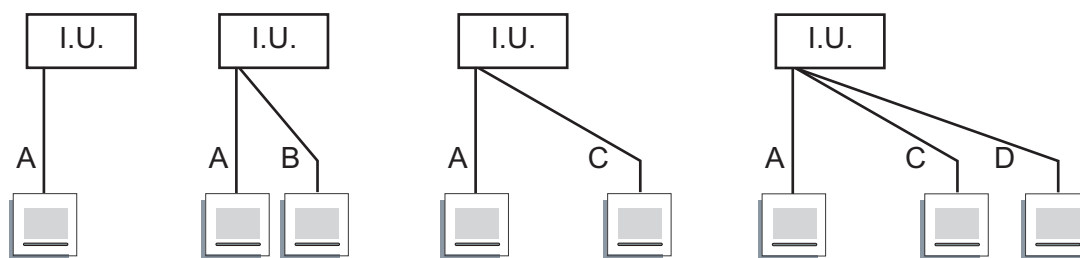

- Remote controller
 - A, B: UTY-RVRY
 - C, D: Other than UTY-RVRY (2-wire type only)
- Remote controller cable
 - A, B, C, D \leq 70 m

NOTES:

- Multiple installation method described above is prohibited to combine with 3-wired type remote controller and 2-wired type remote controller
- Use a junction box depending on the number of the connected remote controller, wiring conditions between the indoor unit and the remote controller, and so on.

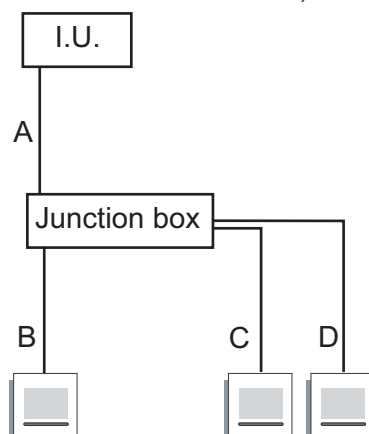

- Remote controller cable
 - A \leq 20 m
 - A + B \leq 70 m, A + C \leq 70 m, A + D \leq 70 m

- **Group control**

With remote controllers, up to 16 indoor units can be simultaneously operated.

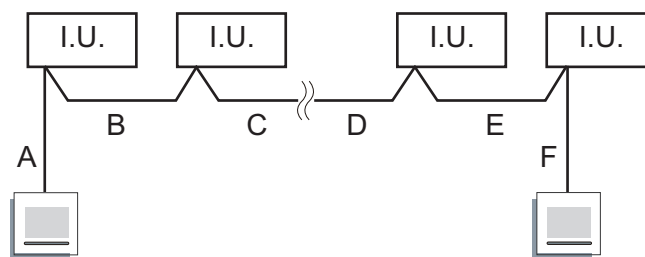

- Remote controller
 - A, F: UTY-RVRY
- Remote controller cable
 - $A, F \leq 70 \text{ m}$, $A + B + C + D + E + F \leq 70 \text{ m}$
 - The requirement (20 m or less) for the remote controller cable length (Junction box—Indoor unit) does not apply to the B, C, D, E cable as the junction boxes are not used in the diagram above.

NOTES:

- Crossover wiring using the terminal on the remote controller is prohibited. Use a junction box when crossover wiring is necessary.
- Remote controller cable (Junction box—Indoor unit): 20 m or less

Electrical wiring

1 remote controller:

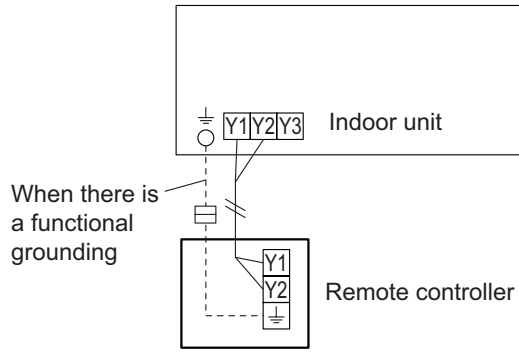

2 remote controllers:

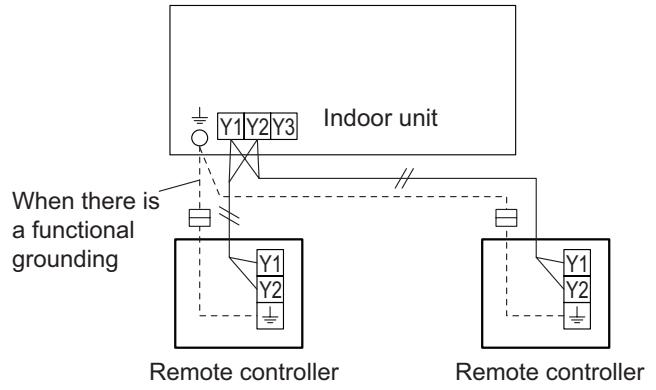

Group control:

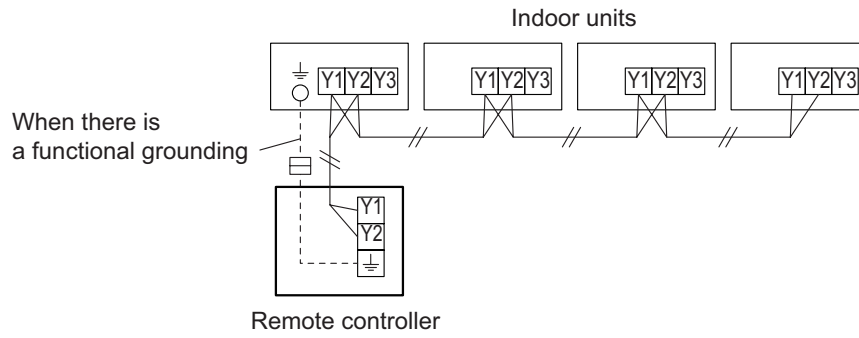

■ Dimensions

Unit: mm

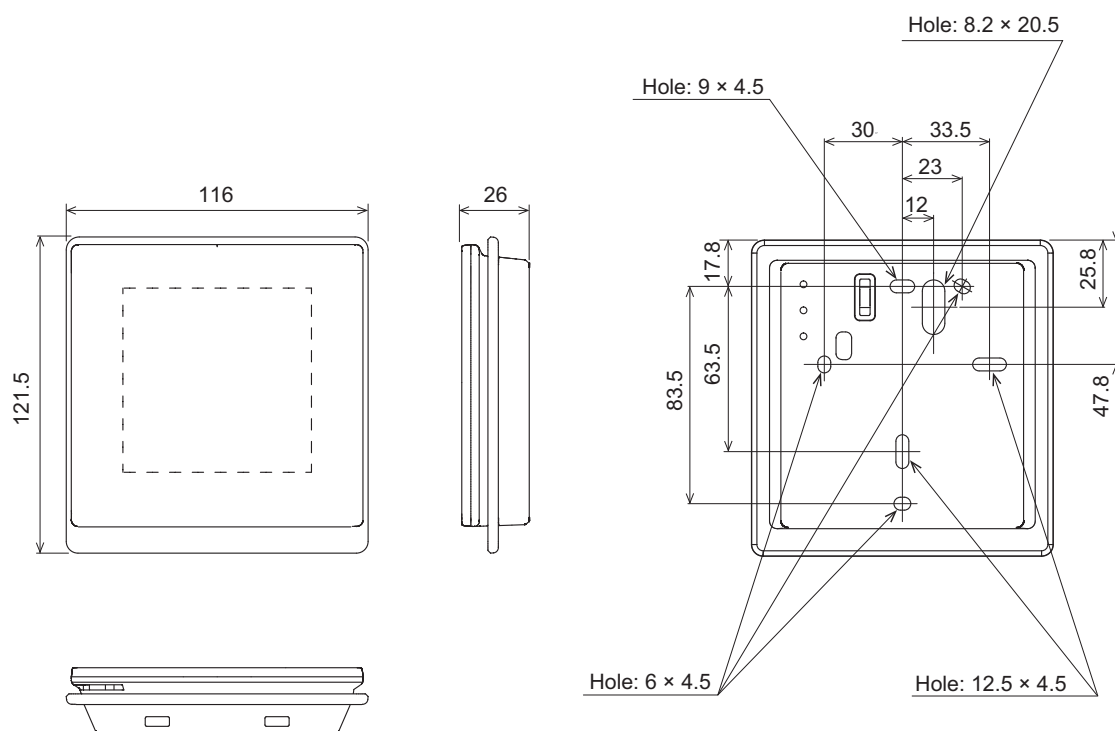

■ Installation space

- This product cannot be installed in a wall.
- Even when you install a remote controller to one of a switch box and the surface of a wall, secure the space shown in following figure. When there is insufficient space, there may be remote controller sensor misdetections and remote controller may be difficult.

Unit: mm

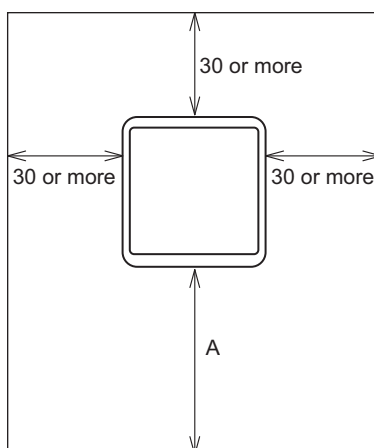

A: Secure enough space where a flat-blade screwdriver to take off a case can be inserted.

■ Installation

For details of installation, refer to the *INSTALLATION MANUAL* for this product.

• Connector removal

Open the front case and remove the connector of the remote controller cable from the connector of the PCB on the front case (back side).

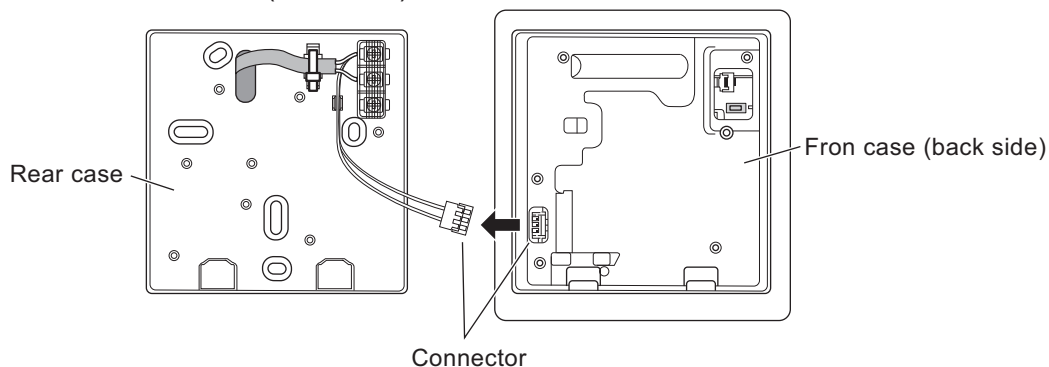

• Switch setting

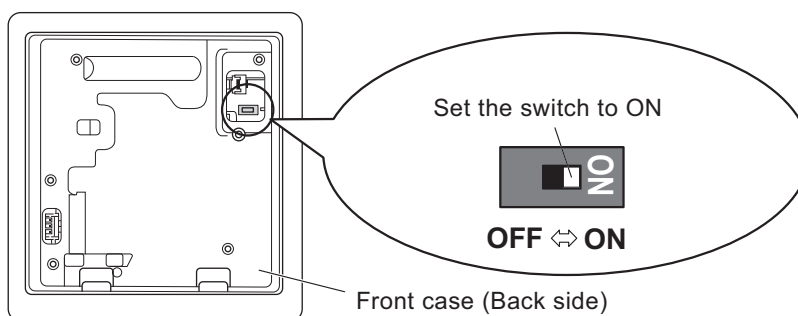

The switch performs the enabling/disabling of the backup function by the internal battery. Before using this product, always set the switch to ON.

NOTES:

- When the power is turned on without setting the switch to ON, the set data by menu operation is erased and cause erroneous operation.
- The switch is set to OFF when shipped from the factory to prevent consumption of the charge.

• Rear case installation

– When attaching to switch box:

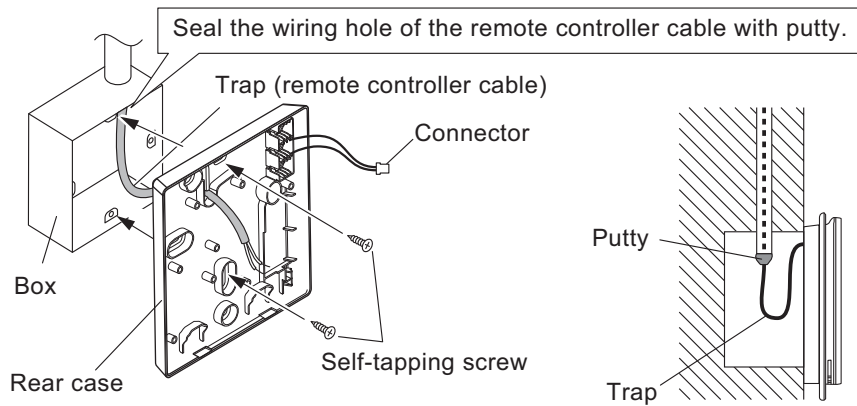

– When attaching to the wall directly:

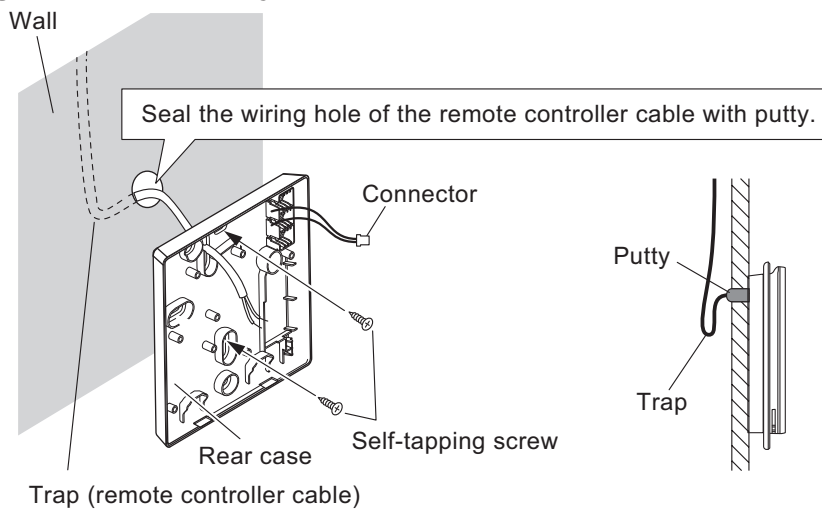

– When routing the cable on-wall:

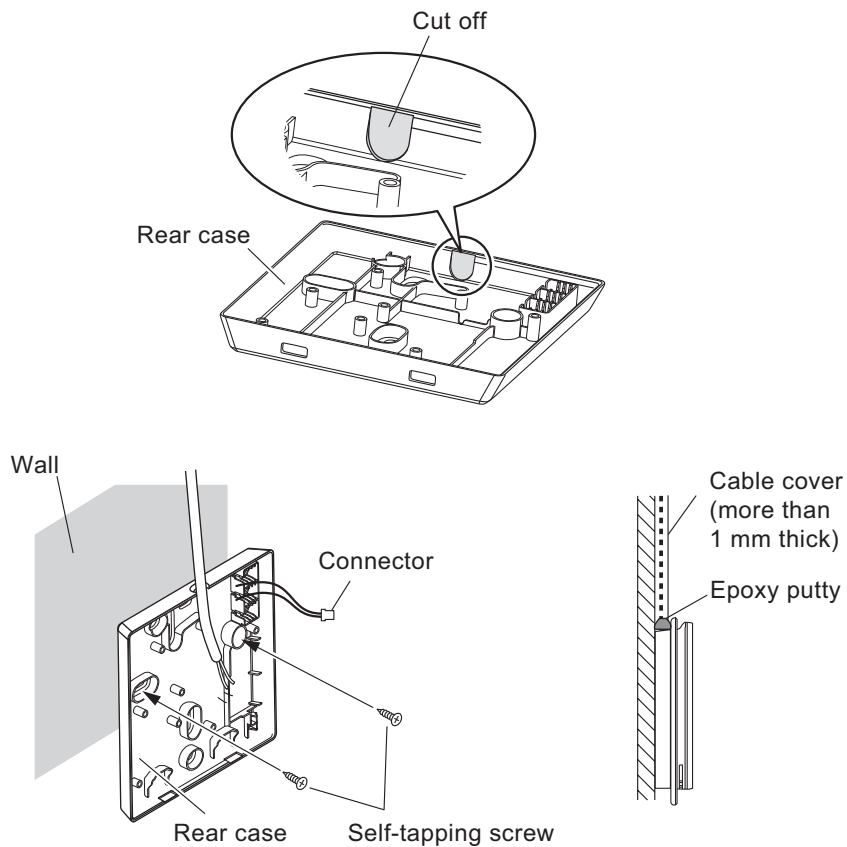

- **Remote controller cable connection**

- Fasten the outside covering of the connection cable with the cable tie.

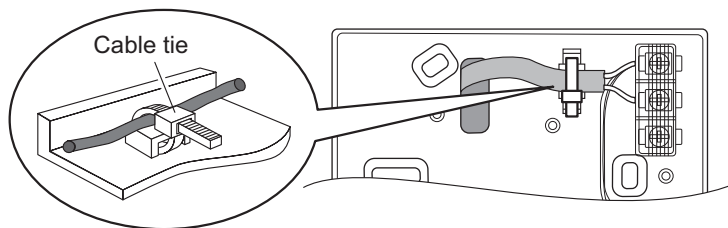

- Connect the connector of the remote controller cable to the connector of the PCB on the front case (back side).

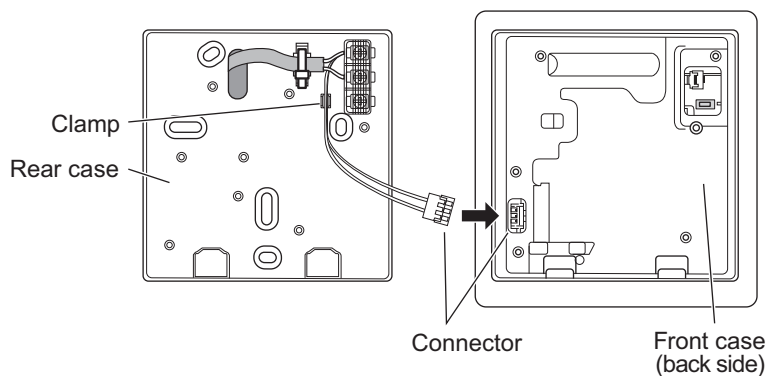

⚠ CAUTION

- Strip length must be specified dimension.
- Insert the cable deeply into the terminal.
- After the cable is inserted, check that the cable is not pulled out.
- Select a flexible cable that does not break the cable sheath even if you bind it with a cable tie around the cable sheath.
- Be careful to avoid breaking the cable by over-tightening the cable tie.

■ Specifications

Input voltage	V	DC 12
Power consumption	W	Max. 1.0
Display		4-inch TFT LCD (480 × 480 pixels) with touch screen
Usage temperature range	°C	0 to 40
Usage humidity range	%	20 to 90 (no condensation)
Storage temperature range	°C	-10 to 60
Storage humidity range	%	20 to 90 (no condensation)
Dimensions (H × W × D)	mm	121.5 × 116 × 26
Weight	g	225

● Wiring specifications

Use	Cable size	Wire type	Remarks
Remote controller cable	0.33 to 1.25 mm ² (22 to 16 AWG)	Non polar 2-core	Use sheathed twist pair cable.*

*: Use shielded cable (locally purchased) in accordance with the regional cable standard.

14-9. Wired remote controller (UTY-RLRY: Optional part)

Overview

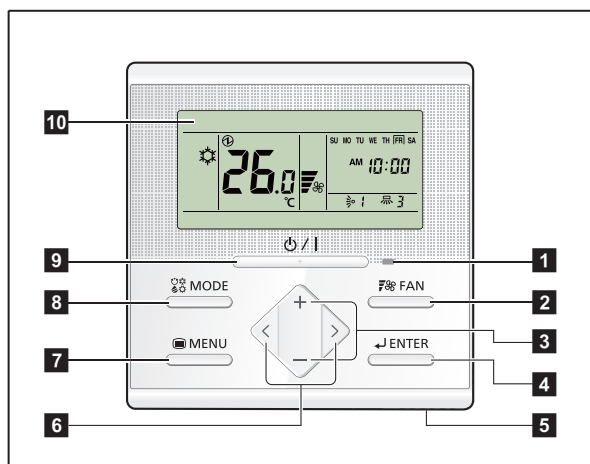

Display panel

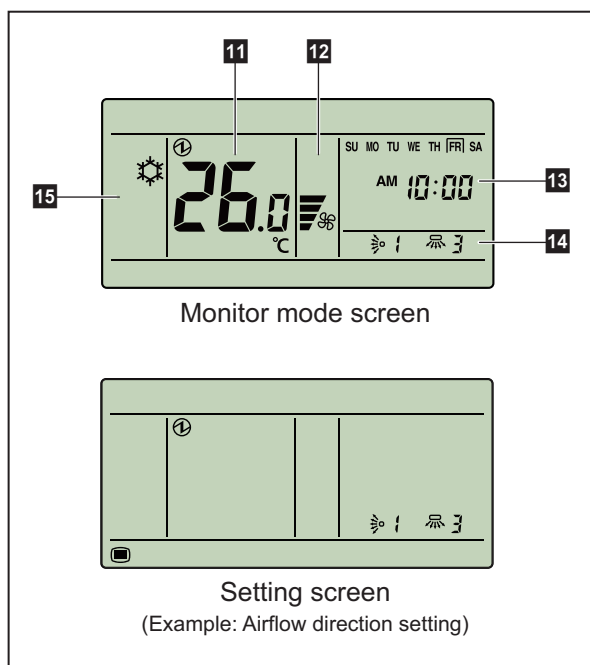

NOTE: For individual icons in Setting screen and related functions, refer to the operation manual.

1 LED lamp (Operation indicator)

Lights while the indoor unit is operating. Blinks when an error occurred.

2 FAN button

Each time the button is pressed, fan speed switches as follows:

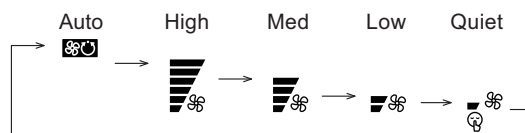

3 +, - buttons (Set temperature buttons)

Used to adjust temperature in Monitor mode screen.

+ button: Raise

- button: Lower

In Setting screen, used to select the setting items.

NOTE: When the operation mode is set to FAN, the temperature cannot be adjusted.

4 ENTER button

Used to enter setting items and settings.

5 Room temperature sensor (inside)

Senses ambient temperature of unit.

6 <, > buttons

Used to select setting items during the setting item selection screen is displayed.

7 MENU button

Used to display the setting item selection screen.

8 MODE button

Each time the button is pressed, operation mode switches as follows:



9 On/Off button

Starts or stops the operation.

NOTE: On/Off button cannot be operated at screens other than the Monitor mode screen.

10 Display panel

Displays Monitor mode screen or Setting screen. Monitor mode screen is home screen of this controller, and the basic operation is performed in this screen. In Setting screen, several settings are adjustable.

11 Temperature indicator

12 Fan speed indicator

13 Clock indicator

14 Airflow direction indicator

15 Operation mode indicator

System diagram

1 remote controller:

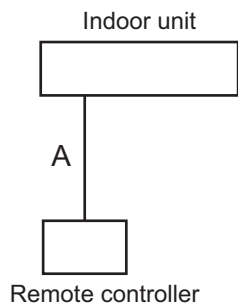

2 remote controllers:

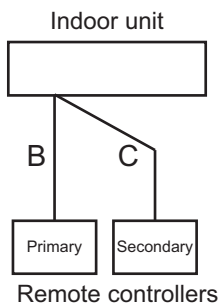

A, B, C: Remote controller cable
 $A \leq 500 \text{ m}; B + C \leq 500 \text{ m}$

Electrical wiring

1 remote controller:

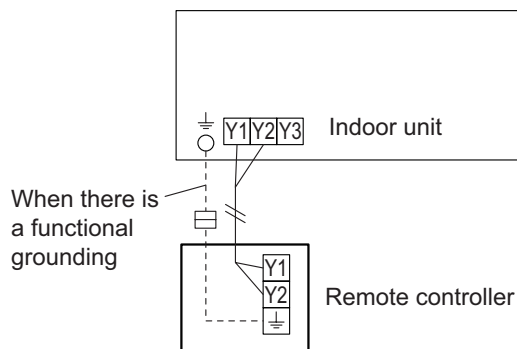

2 remote controllers:

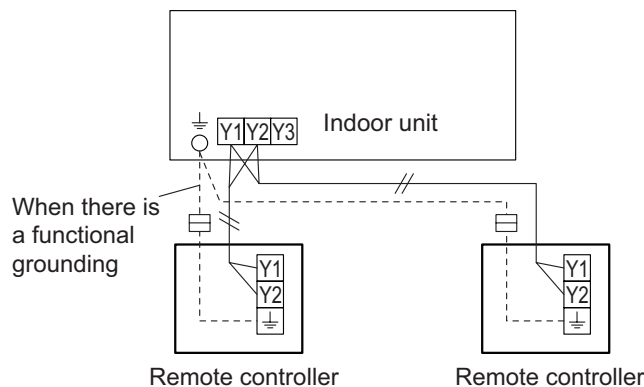

Group control:

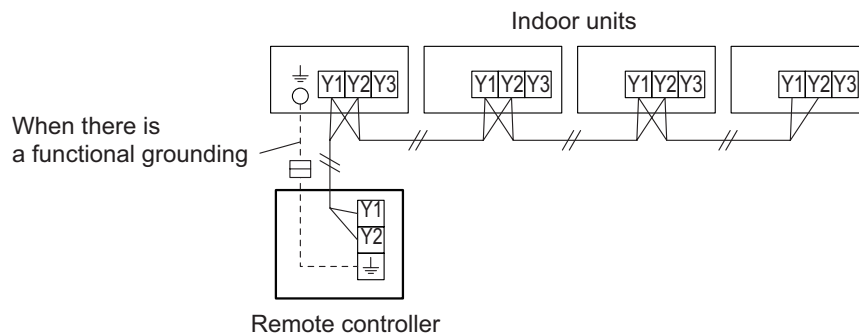

NOTE: Group connection with Polar 3-wired remote controller is not allowed.

■ Specifications

Dimensions and other specifications on the wired remote controller are as follows.

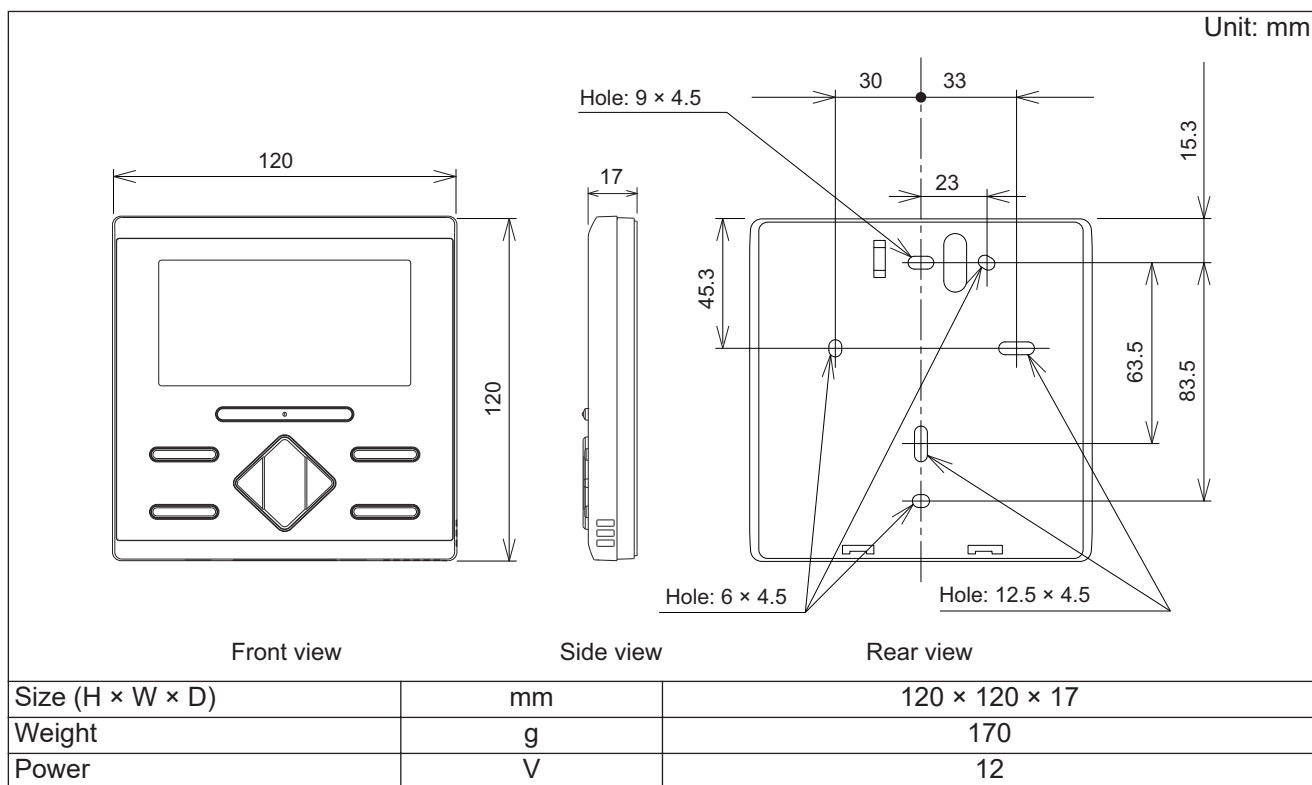

● Wiring specifications

Use	Cable size	Wire type	Remarks
Remote controller cable	0.33 to 1.25 mm ²	Non-polar 2-core, Twisted pair	Use sheathed PVC cable.

■ Installation

Connect the end of remote controller cable directly to the exclusive terminal block.

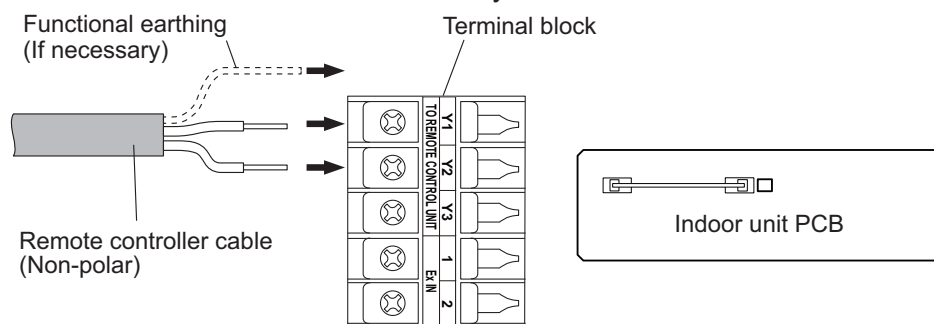

NOTES:

- Layout of terminal block and PCB is varies depending on the type of indoor unit.
- Operation may fail if it is connected to the outdoor unit or the terminal block for power supply.

14-10. Wired remote controller (UTY-RVNYM: Optional part)

Overview

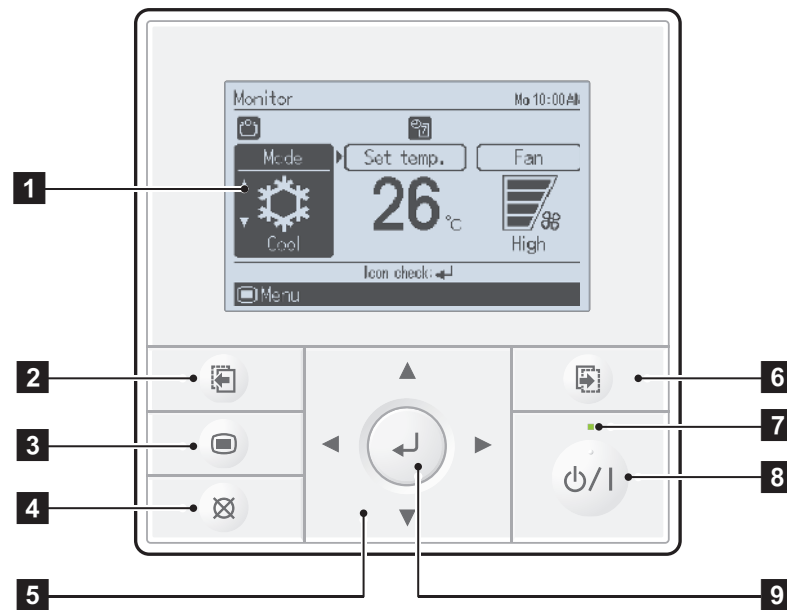

- 1** Display panel (with backlight)
- 2** Screen switch button (Left)
- 3** Menu button
- 4** Cancel button
- 5** Cursor button
- 6** Screen switch button (Right)
- 7** Power indicator
- 8** On/off button
- 9** Enter button

System diagram

1 remote controller:

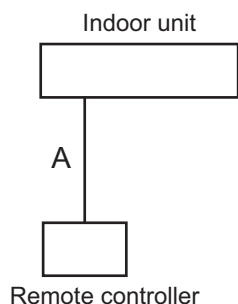

2 remote controllers:

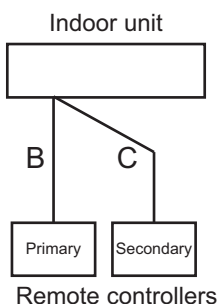

A, B, C: Remote controller cable
 $A \leq 500 \text{ m}$; $B + C \leq 500 \text{ m}$

Electrical wiring

1 remote controller:

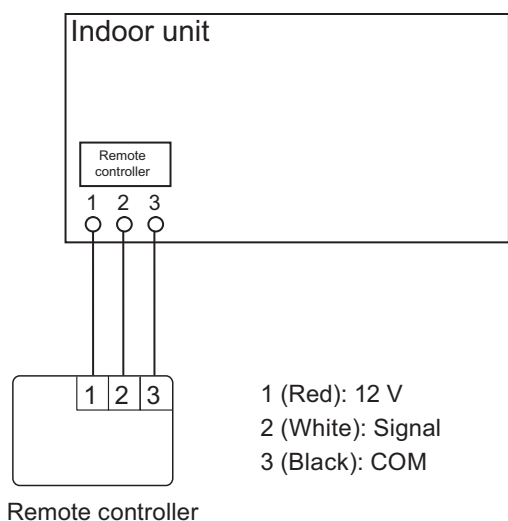

2 remote controllers:

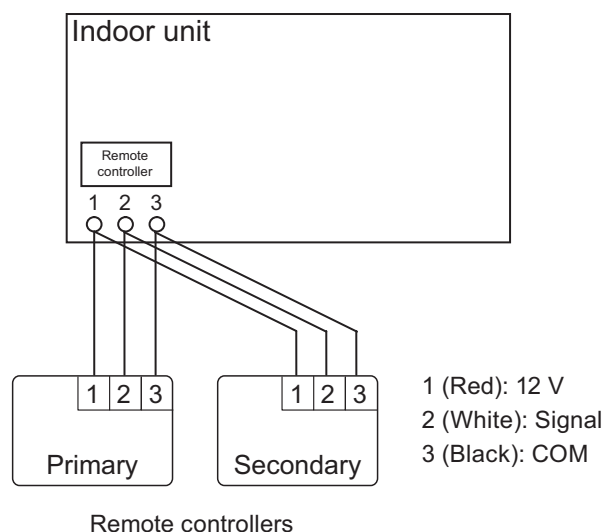

Controller combination

As for the combined usage of the controller, refer to following figures.

● Good

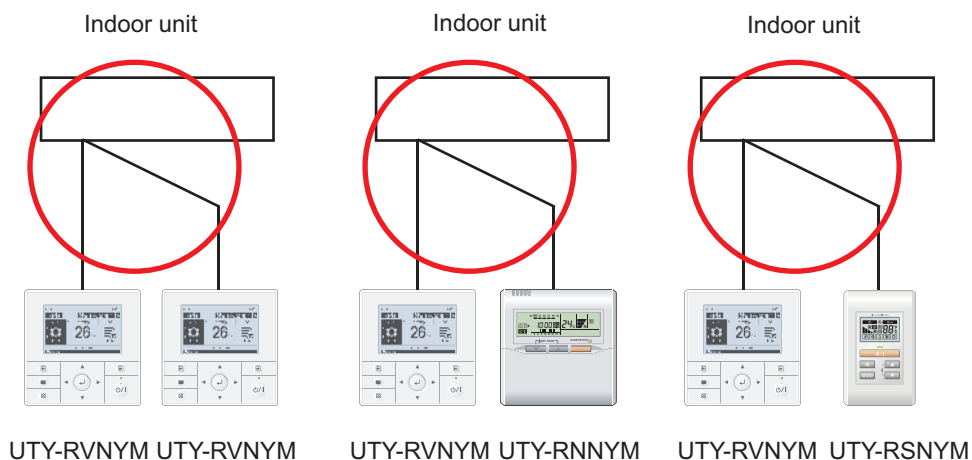

■ Specifications

Unit: mm

Size (H × W × D)	mm	120 × 120 × 21.3
Weight	g	220

● Wiring specifications

Use	Cable size	Wire type	Remarks
Remote controller cable	0.33 mm ²	Polar 3 core	Use sheathed PVC cable.

■ Installation (Remote control main unit)

Installation space:

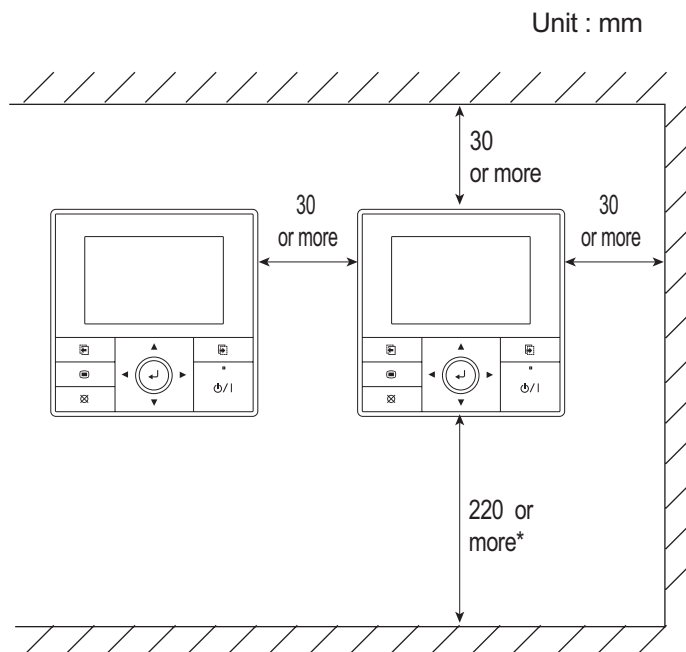

NOTE: Secure enough space where a flat-blade screwdriver to remove the case can be inserted.

Installation procedures:

1. Process the remote controller cable.

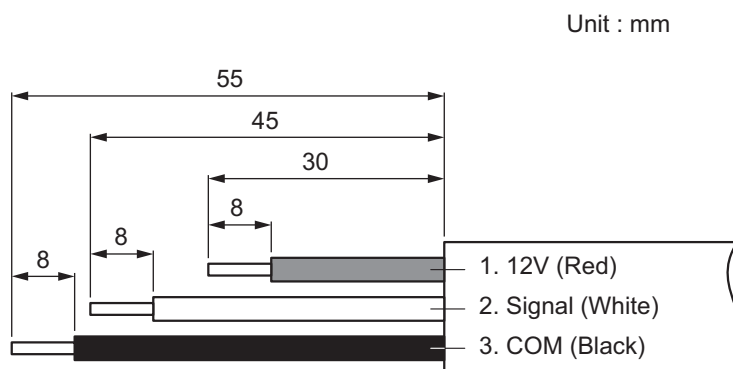

2. Insert the flat-blade screwdriver and twist it slightly to separate the front case and rear case.

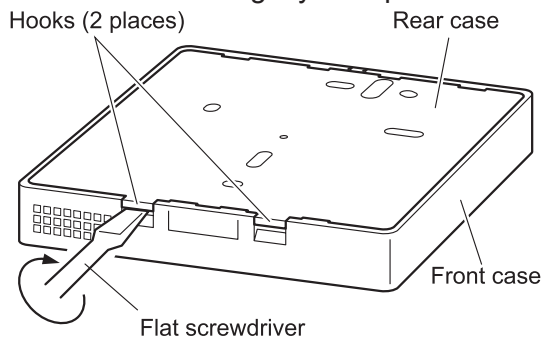

3. Attach the remote controller.

• **When attaching to switch box:**

- Seal the wiring hole of the remote controller cable.
- Put a remote controller cable through the hole of the rear case.
- Fix the rear case by securing it with attached screws (2 places).

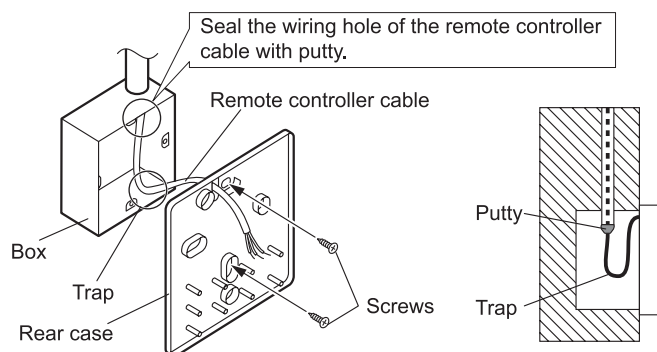
• **When attaching to the wall directly:**

- Seal the wiring hole of the remote controller cable.
- Put a remote controller cable through the back hole of the rear case of the main body.
- Fix the rear case by securing it with attached screws (2 places).

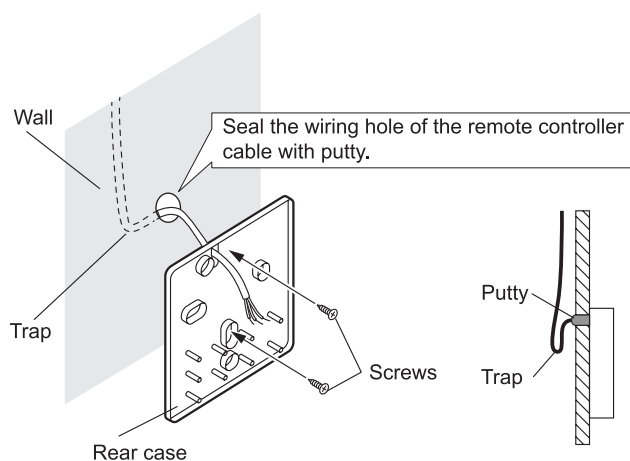
• **When routing the cable on-wall:**

- Cut off the cable guide of the front case with using a knife or a nipper.
- Deburr the edge of the cable guide.

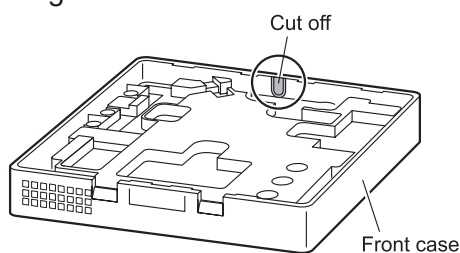

- Fix the rear case by securing it with attached screws (2 places).

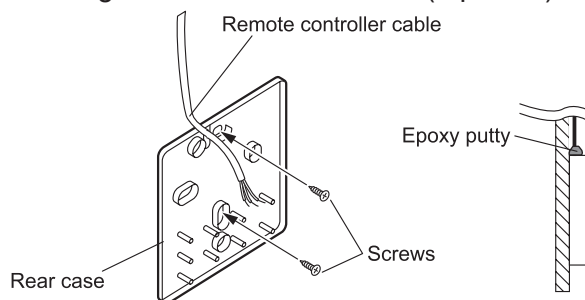

4. Connect the cable to the terminals on the front case.
Fix the cable together with the sheath with the cable tie. Cut off the excess cable tie.

Tightening torque	
Terminal screw	0.8 to 1.2 N•m

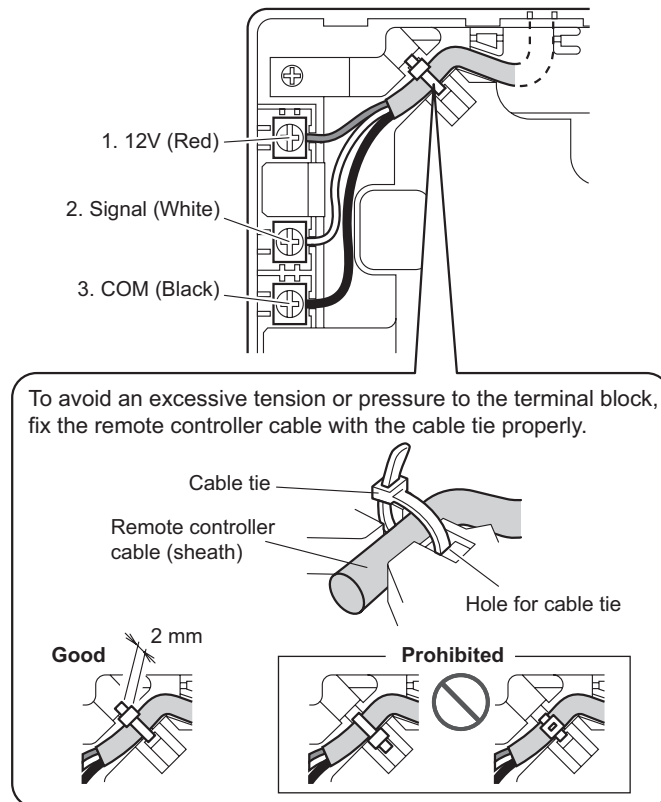

⚠ CAUTION

- Be careful to avoid breaking the cable by over-tightening the cable tie.
- When connecting the remote controller cables, do not over-tighten the screws.

5. Attach the front case.
 - Insert after adjusting upper part of front case.
 - When insert the front case, do not pinch the cable.

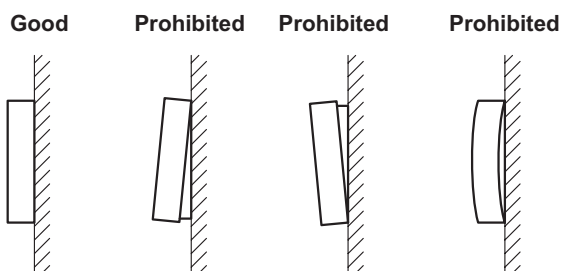
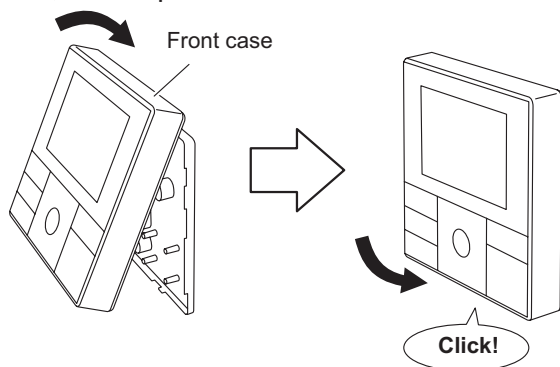

⚠ CAUTION

Insert the upper case firmly. If improperly attached, it will cause the upper case to fall off.

■ Installation

Connection pattern of wired remote controller varies by the type of the connected indoor unit.

● When connecting to terminal block (for Compact cassette, Slim duct, and Mini duct types)

Connect the end of remote controller cable directly to the exclusive terminal block.

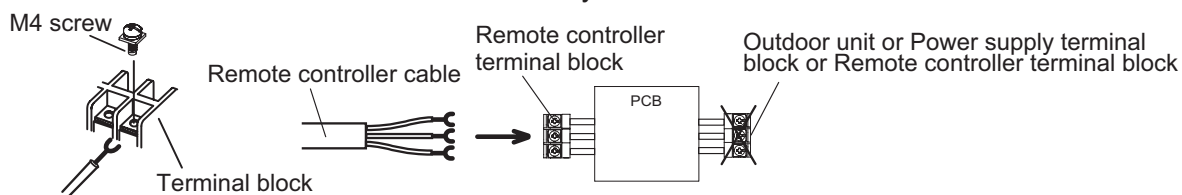

NOTE: It may be failed if it is connected to the outdoor unit or the terminal block for power supply.

14-11. Wired remote controller (UTY-RNRYZ*: Optional part)

Overview

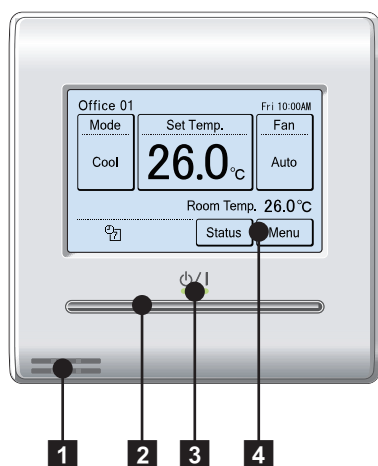

Display panel

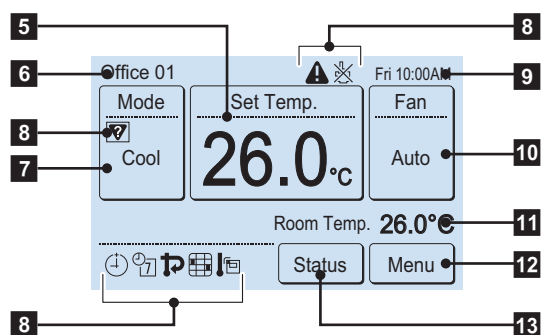

- 1 Remote temperature sensor (inside)**
- 2 On/off button**
Operable only while displaying the "Monitor mode" screen.
- 3 LED lamp (operation indicator)**
- 4 Touch panel display**
- 5 Set temperature**
Operating temperature can be set.
- 6 Remote controller group name**
- 7 Mode**
Operation mode can be set.
- 8 Status icons**
- 9 Clock**
- 10 Fan**
Fan speed can be set.
- 11 Room temperature**
- 12 Menu**
Various settings can be set.
- 13 Status**
Status of the indoor unit and error can be checked.

NOTE: Functions may differ by type of the indoor unit. For details, refer to the operation manual.

System diagram

1 remote controller:

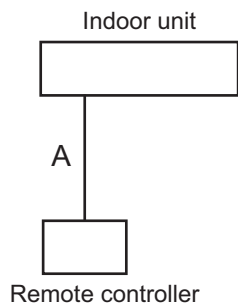

2 remote controllers:

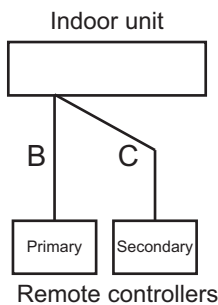

A, B, C: Remote controller cable
 $A \leq 500 \text{ m}; B + C \leq 500 \text{ m}$

Electrical wiring

1 remote controller:

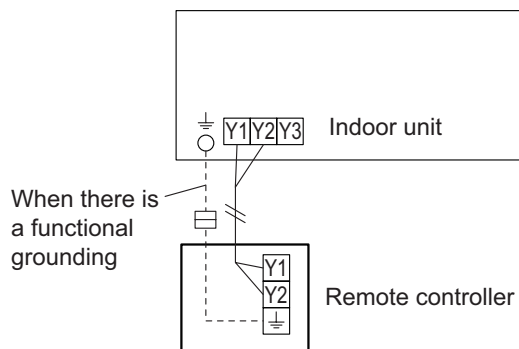

2 remote controllers:

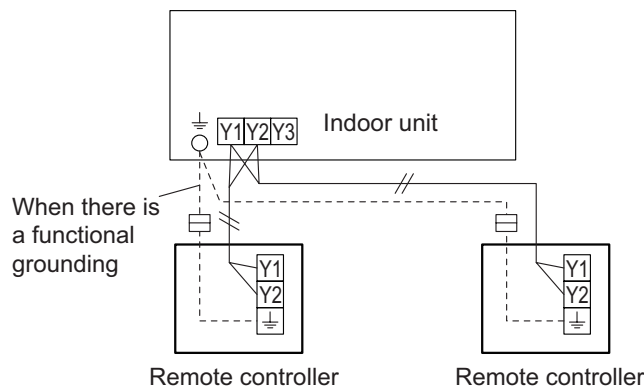

Group control:

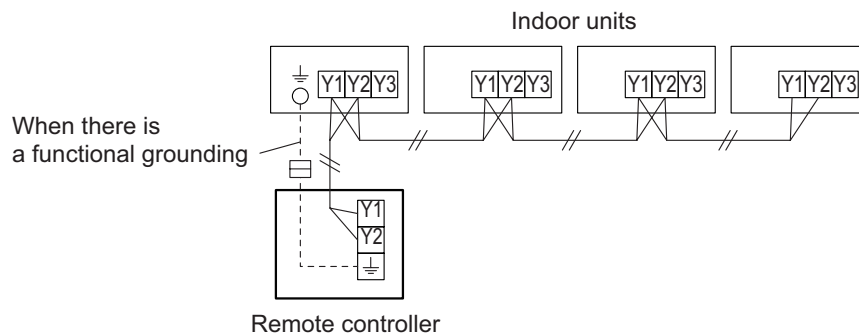

NOTE: Group connection with Polar 3-wired remote controller is not allowed.

■ Specifications

Dimensions and other specifications on the wired remote controller are as follows.

[Unit : mm]

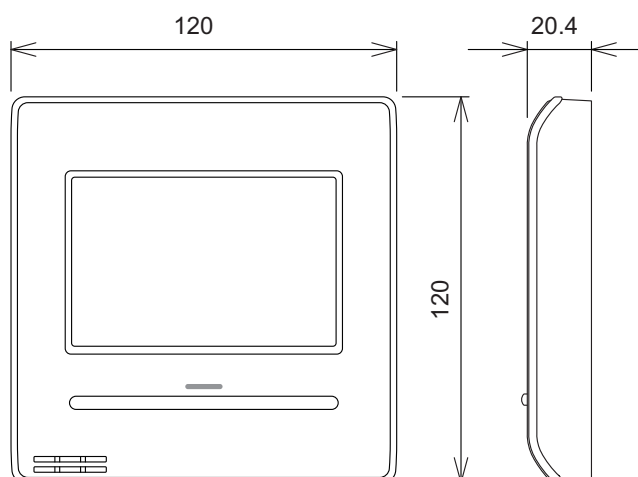

Model name	UTY-RNRYZ*
------------	------------

Display	3.8-inch FSTN LCD (255 × 160 dots) with touch panel	
Dimensions (H × W × D)	mm	120 × 120 × 20.4
Weight	g	220
Input voltage	V	DC 12
Power consumption	W	Max. 0.3
Usage temperature range	°C	0 to 40
Usage humidity range	%	20 to 90 (no condensation)
Storage temperature range	°C	-10 to 60
Storage humidity range	%	20 to 90 (no condensation)

● Wiring specifications

Use	Cable size	Wire type	Remarks
Remote controller cable	0.33 to 1.25 mm ²	Non-polar 2-core, Twisted pair	Use sheathed PVC cable.

■ Installation

Connect the end of remote controller cable directly to the exclusive terminal block.

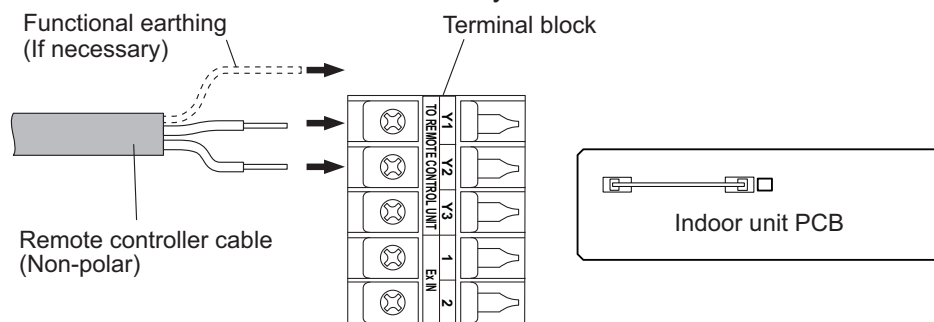

NOTES:

- Layout of terminal block and PCB is varies depending on the type of indoor unit.
- Operation may fail if it is connected to the outdoor unit or the terminal block for power supply.

14-12. Wired remote controller (UTY-RCRYZ1: Optional part)

■ Overview

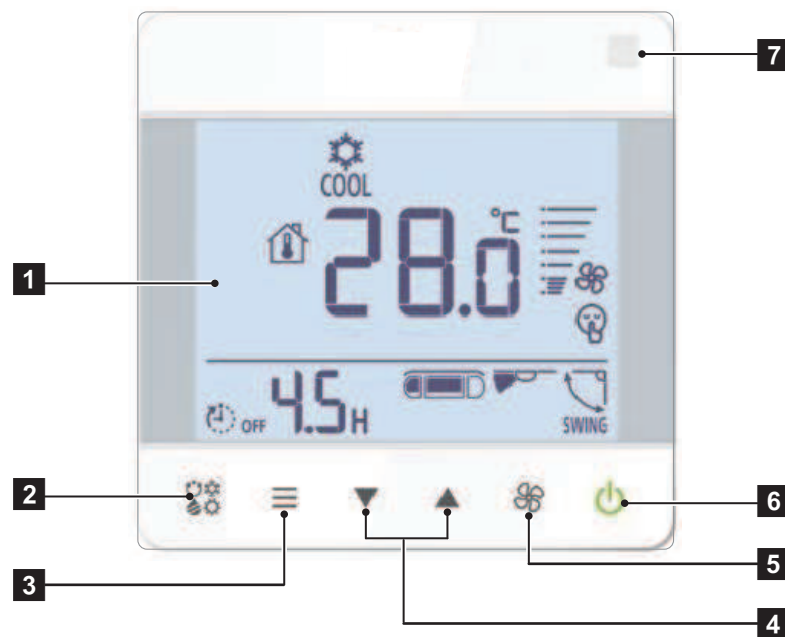

- 1** Display panel
- 2** MODE button
- 3** Menu button
- 4** ▼, ▲ buttons (Set temperature buttons)
- 5** FAN button
- 6** On/off button
- 7** Wireless remote controller signal receiving section

■ System diagrams

- Single remote control

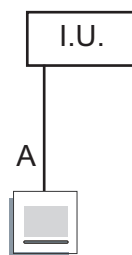

Remote controller cable
 $A \leq 500 \text{ m}$

■ Electrical wiring

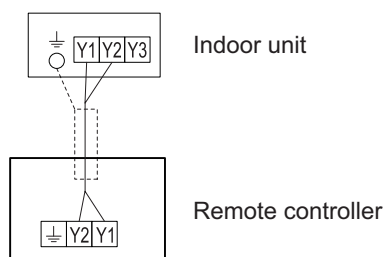

■ Specifications

Unit: mm		
Size (H × W × D)	mm	86 × 86 × 32
Weight	g	135

● Wiring specifications

Use	Cable size	Wire type	Remarks
Remote controller cable	0.33 to 1.25 mm ² (22 to 16 AWG)	Non polar 2-core	Use sheathed twist pair cable.*

*: Use shielded cable (locally purchased) in accordance with the regional cable standard.

■ Installation

• Connection pattern

NOTE: Connection pattern is different according to type of Indoor unit.

Indoor unit type	Connection pattern
All cassette type	Pattern A
All duct type	Pattern A
Compact floor type	Pattern A
Wall mounted type	Pattern B

• Pattern A

1. Connect the end of remote controller cable directly to the exclusive terminal block.
2. Set the DIP switch (SW1) to "2WIRE" on the PCB of the indoor unit.

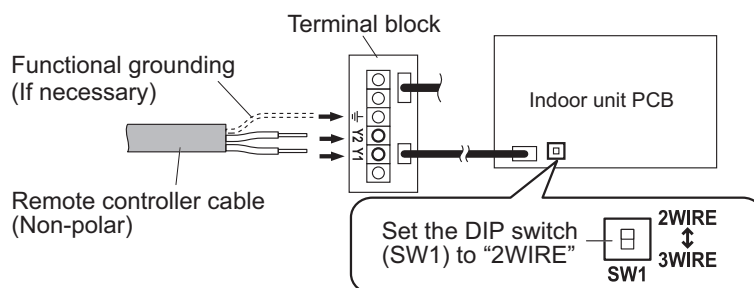

NOTES:

- Layout of terminal block and PCB is varies depending on the type of indoor unit.
- Operation may fail if it is connected to the outdoor unit or the terminal block for power supply.

- **Pattern B**

1. Use a tool to cut off the terminal on the end of the remote controller cable, and then remove the insulation from the cut end of the cable as shown below.

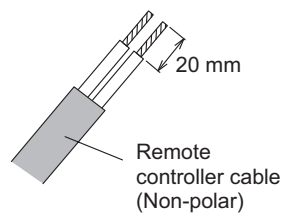

2. Connect the remote controller cable and connecting cable as shown below. Be sure to insulate the connection between the cables.

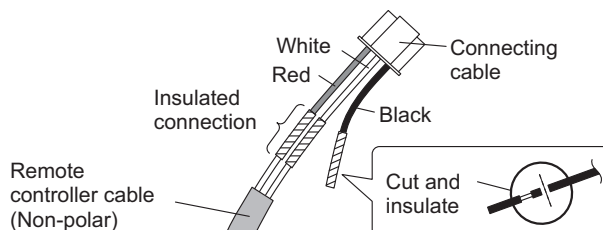

3. Connect the remote controller cable to the connecting cable, and insert it to the connector. Set the DIP switch (SW1) to "2WIRE" on the PCB of the indoor unit.

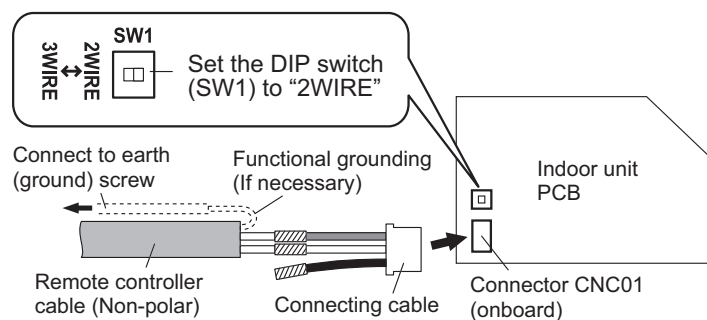

NOTE: Layout of terminal block and PCB is varies depending on the type of indoor unit.

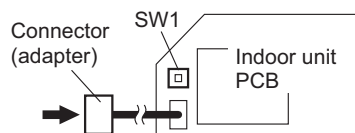

14-13. Simple remote controller (UTY-RSNYM: Optional part)

Overview

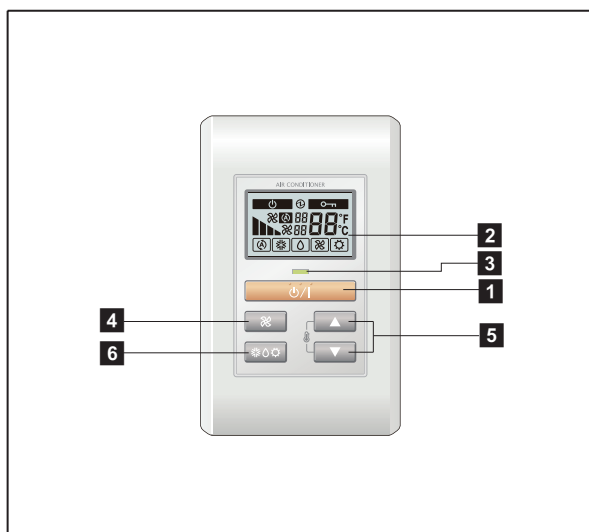

Display panel

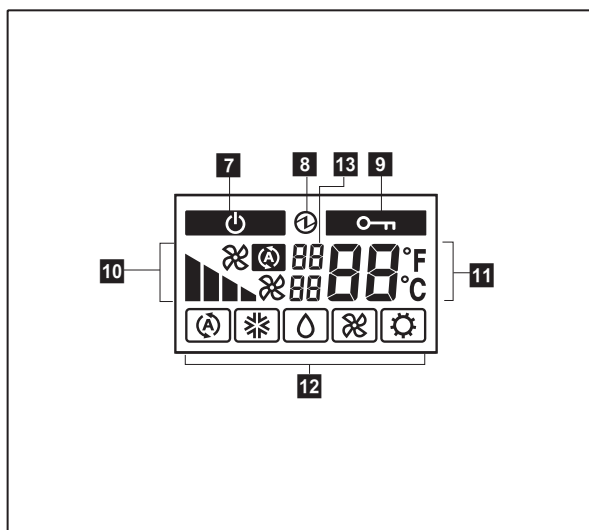

1 START/STOP button

Starts and stops operation.





2 Display backlight button

Lights during operation.

3 Operation lamp

Lights during operation.





4 FAN button

Selects the fan speed (AUTO , HIGH , MED , LOW , and QUIET .

5 SET TEMP. button

Selects the setting temperature.

6 MODE button

Selects the operating mode (AUTO , COOL , DRY , FAN , HEAT .

7 Standby indicator

Indicates during the oil recovery and defrosting operation.

8 Power source indicator

Indicates the main power is on.

9 Central control indicator

Indicates when function is locked.

10 Fan speed indicator

Deletes the weekly timer schedule.

11 Set temperature

- Indicates error history number in error code history display mode.
- Indicates indoor unit address in address display mode.

12 Operating mode indicator

13 Indicator

- Upper:
 - Indicates the error code in error code history display mode and in self diagnosis mode.
 - Indicates the refrigerant system address in address display mode.
- Lower: Indicates the remote controller address in error code history display mode, address display mode, and self diagnosis mode.

System diagram

1 remote controller:

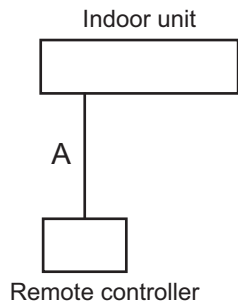

2 remote controllers:

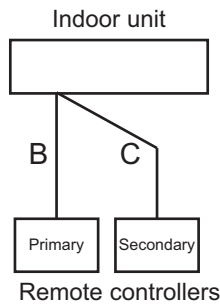

A, B, C: Remote controller cable
 $A \leq 500 \text{ m}; B + C \leq 500 \text{ m}$

Electrical wiring

1 remote controller:

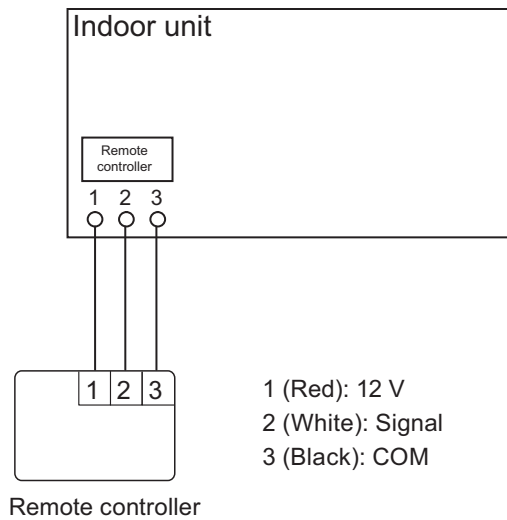

2 remote controllers:

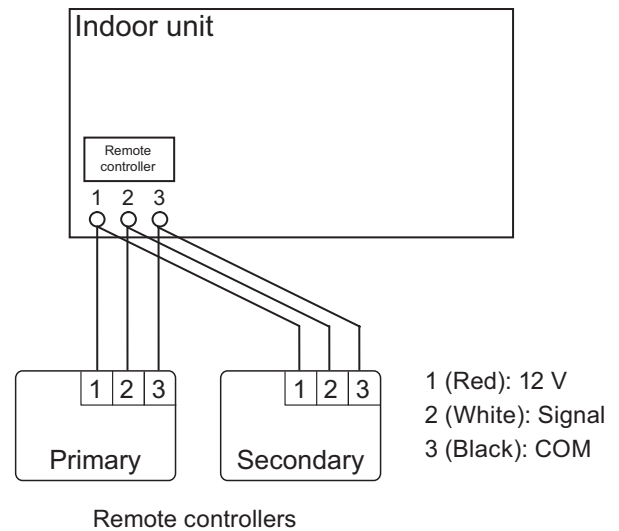

■ Specifications

Dimensions and other specifications on the wired remote controller are as follows.

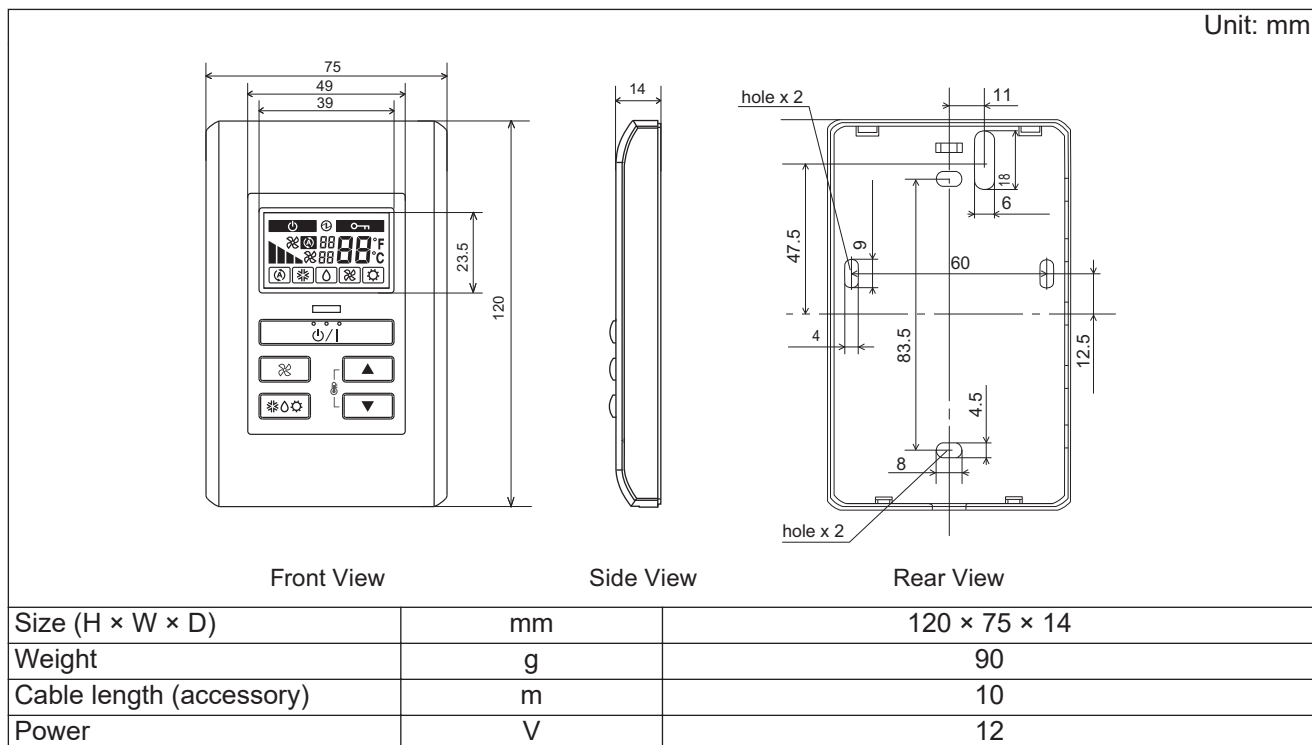

● Wiring specifications

Use	Size	Wire type	Remarks
Remote controller cable	0.33 mm ²	Polar 3 core	Use sheathed PVC cable.

■ Installation

Connection pattern of wired remote controller varies by the type of the connected indoor unit.

● When connecting to terminal block (for Compact cassette, Slim duct, and Mini duct types)

Connect the end of remote controller cable directly to the exclusive terminal block.

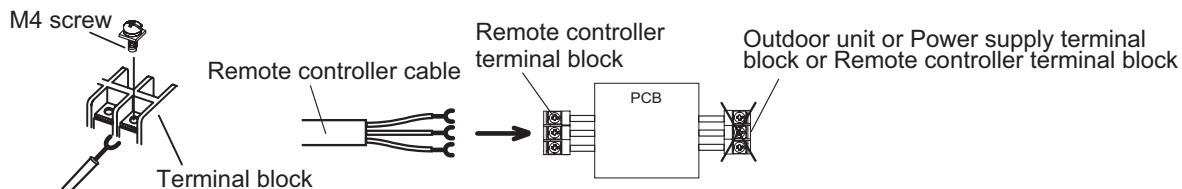

NOTE: It may be failed if it is connected to the outdoor unit or the terminal block for power supply.

14-14. Simple remote controller (UTY-RSRY and UTY-RHRY: Optional parts)

Overview

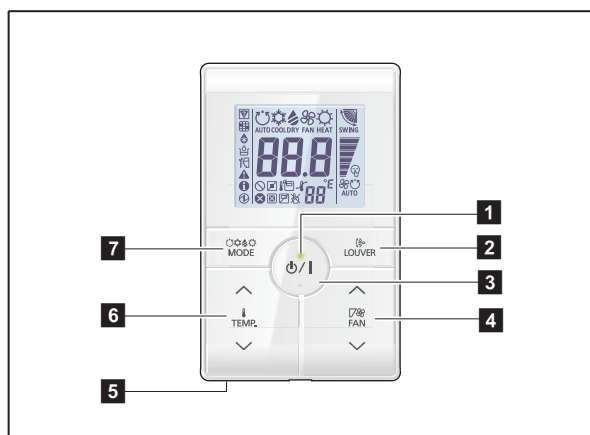

Display panel

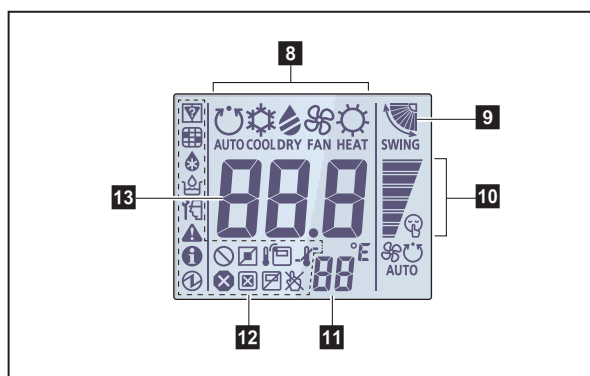

1: Available only for UTY-RSR.

*2: Not available for a heat pump model unless it is set up as an administrative indoor unit.

*3: Not available for a heat pump model.

*4: Not available for a cooling-only model.

*5: Set the function setting of the indoor unit accordingly.

*6: During address display mode.

1 LED lamp

Lights during operation.

2 Louver button

Adjusts the airflow direction.

3 START/STOP button

Starts and stops operation.

4 FAN control button

Switches the fan speed as follows:

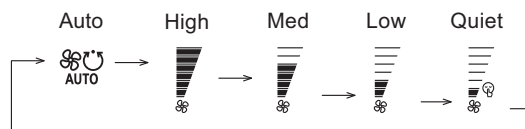

5 Room temperature sensor (inside)

Senses ambient temperature of unit.

6 Set temperature button

Selects the setting temperature. (18—30 °C [COOL], 10—30 °C [HEAT])

7 Operation mode button*1

Switches the operation mode as follows:



8 Operating mode indicator

9 Airflow direction indicator

10 FAN speed indicator

11 Remote controller address indicator

12 Status icons

- Mode mismatch
- Filter sign *5
- Defrost operation
- Oil recovery operation
- Under maintenance
- Error
- Special state
- Conducting electricity
- Emergency stop
- Operation controlled
- Forced stop
- Remote controller sensor is enabled *5
- Central controlled
- Setting temperature range is enabled
- Operation prohibited

13 Set temperature

Indicates indoor unit address. *6

System diagram

1 remote controller:

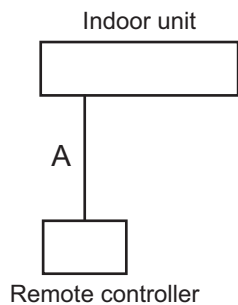

2 remote controllers:

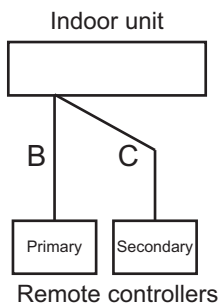

A, B, C: Remote controller cable
 $A \leq 500 \text{ m}; B + C \leq 500 \text{ m}$

Electrical wiring

1 remote controller:

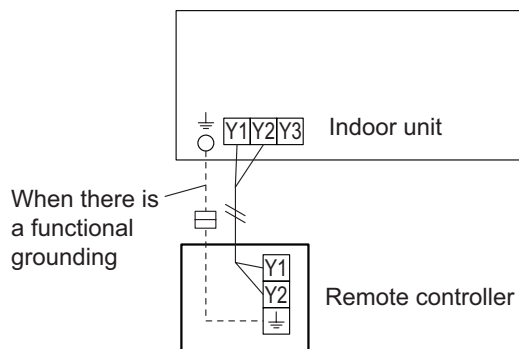

2 remote controllers:

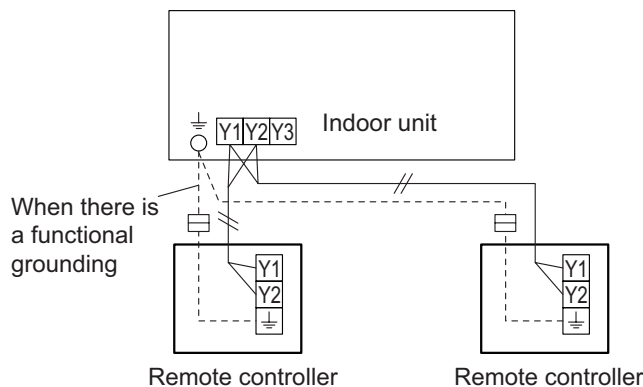

Group control:

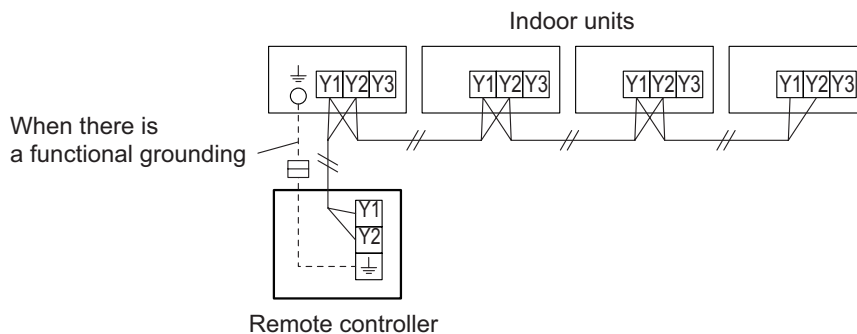

NOTE: Group connection with Polar 3-wired remote controller is not allowed.

Specifications

Dimensions and other specifications on the wired remote controller are as follows.

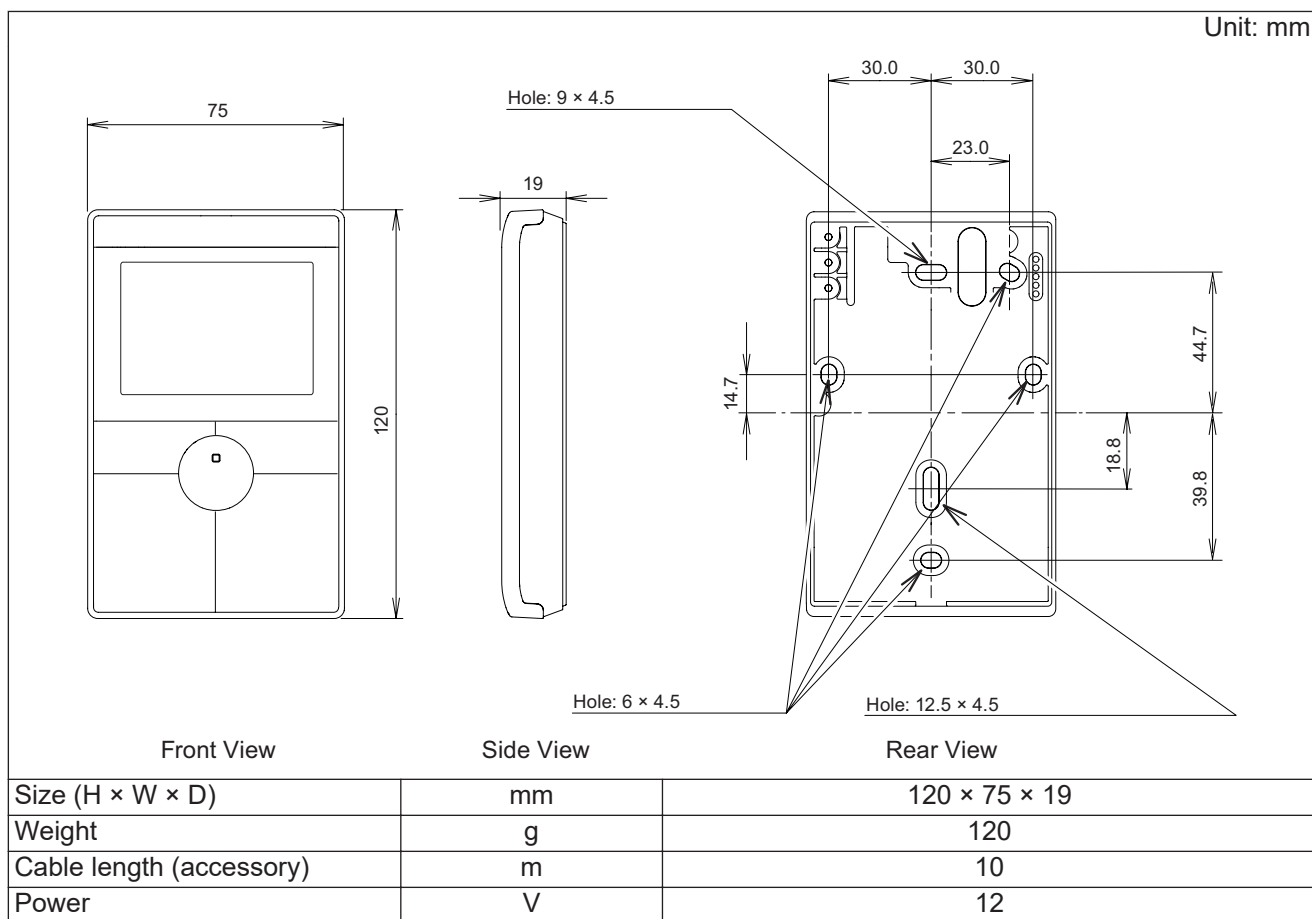

Wiring specifications

Use	Cable size	Wire type	Remarks
Remote controller cable	0.33 to 1.25 mm ²	Non-polar 2-core, Twisted pair	Use sheathed PVC cable.

Installation

Connect the end of remote controller cable directly to the exclusive terminal block.

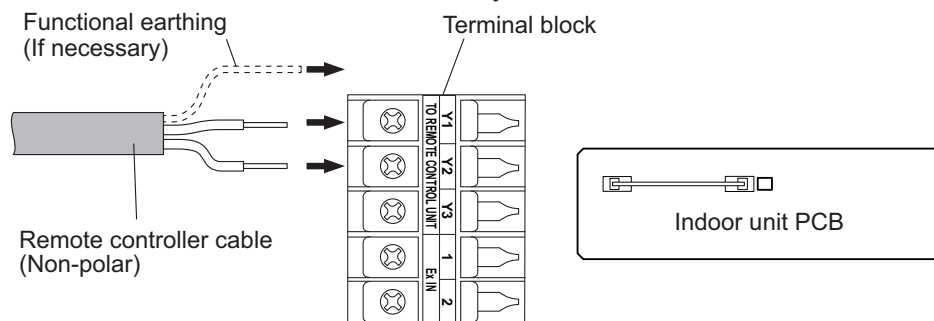

NOTES:

- Layout of terminal block and PCB is varies depending on the type of indoor unit.
- Operation may fail if it is connected to the outdoor unit or the terminal block for power supply.

15. Function settings

To adjust the functions of this product according to the installation environment, various types of function settings are available.

NOTE: Incorrect settings can cause a product malfunction.

15-1. Compact cassette, Mini duct, Slim duct types indoor unit (setting by DIP switch)

By using some components on the PCB, you can change the function settings.

Related components on the PCB and the applicable settings:

Component		Setting content
DIP switch	SW100	1
		2
		3
		4
	SW101	1
		2
		3

■ Component location

Components on the indoor unit main PCB used for the function settings are located as shown in the following figure.

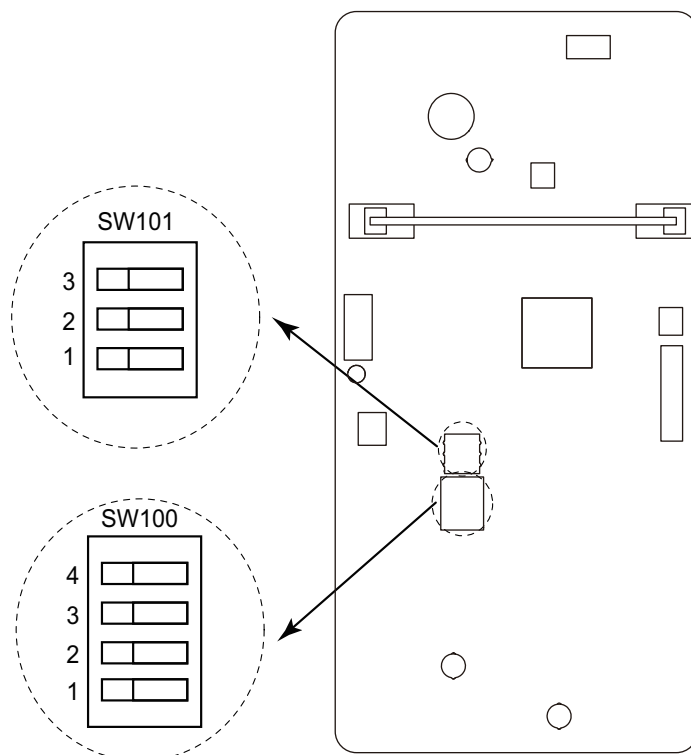

■ DIP switch setting

- **SW100: Remote controller address setting**

When operating a number of indoor units by using a wired remote controller, DIP switch setting for assigning unit number to each indoor unit is required.

The slide switches are normally set to make the unit number 00.

Remote controller address	Switch number				Factory setting
	1	2	3	4	
00	OFF	OFF	OFF	OFF	◆
01	ON	OFF	OFF	OFF	
02	OFF	ON	OFF	OFF	
03	ON	ON	OFF	OFF	
04	OFF	OFF	ON	OFF	
05	ON	OFF	ON	OFF	
06	OFF	ON	ON	OFF	
07	ON	ON	ON	OFF	
08	OFF	OFF	OFF	ON	
09	ON	OFF	OFF	ON	
10	OFF	ON	OFF	ON	
11	ON	ON	OFF	ON	
12	OFF	OFF	ON	ON	
13	ON	OFF	ON	ON	
14	OFF	ON	ON	ON	
15	ON	ON	ON	ON	

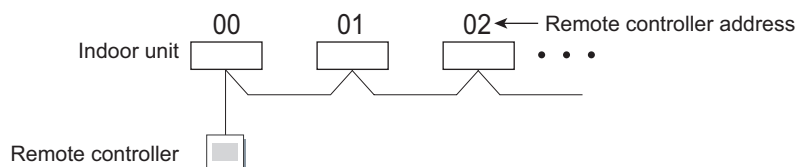

- **SW101-Switch 1: Drainage function setting**

Switch 1	Drainage function	Factory setting
ON	Disabled	
OFF	Enabled	◆

- **SW101-Switch 2: Auto louver grille setting**

When Auto Louver Grille Kit (optional parts) is attached, set to "Enabled".

Switch 2	Auto louver grille setting	Factory setting
ON	Enabled	
OFF	Disabled	◆

- **SW101-Switch 3: Fan delay setting**

When the indoor unit is stopped while operating in conjunction with auxiliary heater, the indoor unit fan operation will continue for 1 minute.

Switch 3	Fan delay	Factory setting
ON	Enabled	
OFF	Disabled	◆

15-2. Medium static pressure duct type

By using some components on the PCB, you can change the function settings.

Related components on the PCB and the applicable settings

Component		Setting content
DIP switch101	1	Drainage function setting
	2	Setting change prohibited
	3	Fan delay setting
	4	Setting change prohibited

● Component location

Components on the indoor unit main PCB used for the function settings are located as shown in the following figure.

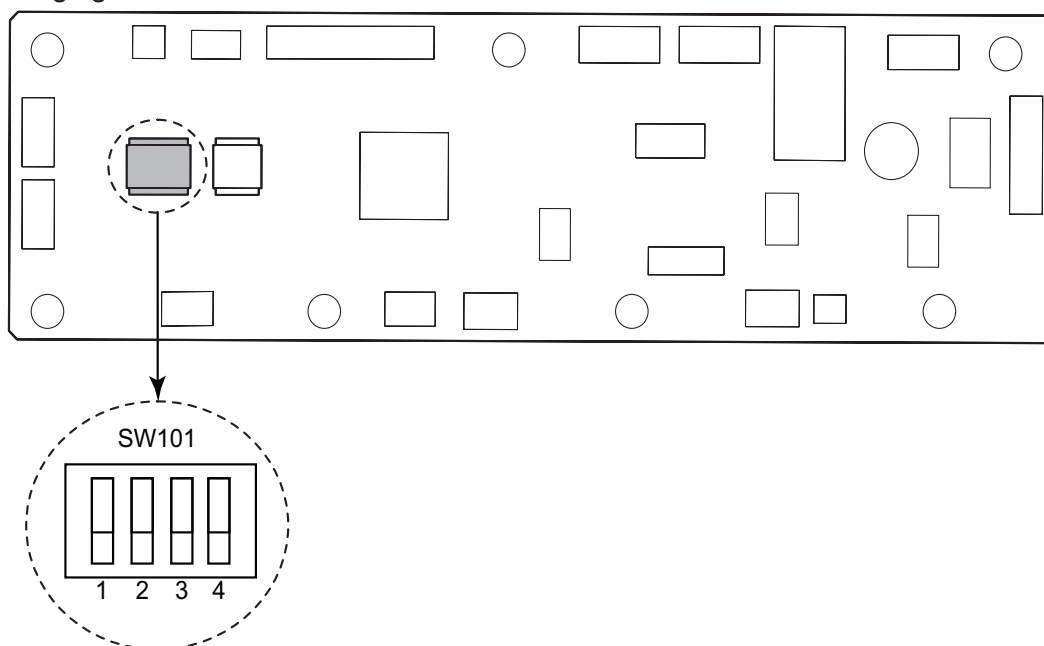

● DIP switch setting

- **Switch 1: Drainage function setting (SW101)**

Switch 1	Drainage function	Factory setting
ON	Disabled	
OFF	Enabled	◆

- **Switch 2: Setting change prohibited (SW101)**

- **Switch 3: Fan delay setting (SW101)**

When the indoor unit is stopped while operating in conjunction with auxiliary heater, the indoor unit fan operation will continue for 1 minute.

Switch 3	Fan delay	Factory setting
ON	Enabled	
OFF	Disabled	◆

- **Switch 4: Setting change prohibited (SW101)**

15-3. Indoor unit (setting by wireless remote controller)

CAUTION

This setting changes the function settings used to control the indoor unit according to the installation conditions. Incorrect settings can cause a product malfunction.

- After the power is turned on, perform the “Function setting” according to the installation conditions using the remote controller.
- The settings may be selected between the following two: Function number or Setting number.
- Settings will not be changed if invalid numbers or setting numbers are selected.

■ Preparation

Before connecting the power supply of the indoor unit, reconfirm following items:

- Piping air tightness test and vacuuming have been performed firmly.
- There is no wiring mistake. Then, connect the power supply of the indoor unit.

■ AR-REW3E (for Wall mounted type KGTG), AR-REW4E (for Wall mounted type KETF[-B]), and AR-REM7E (for Floor type)

● Button name and function

During address setting mode, indoor unit reject the any operation command from remote controller.

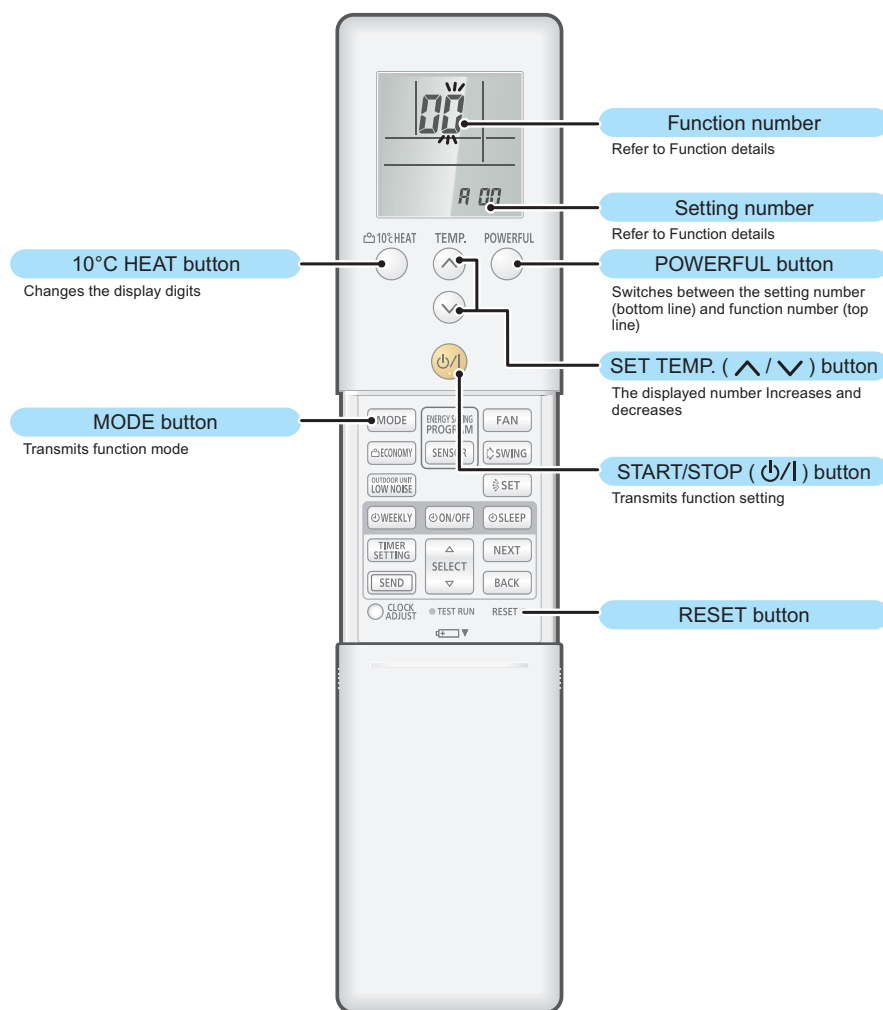

NOTE: The number of buttons varies by the remote controller model.

● Function setting procedure

1. Connect the power supply of the outdoor unit.
2. To enter the function setting mode, while holding down the POWERFUL and TEMP. ^ button, press the RESET button.

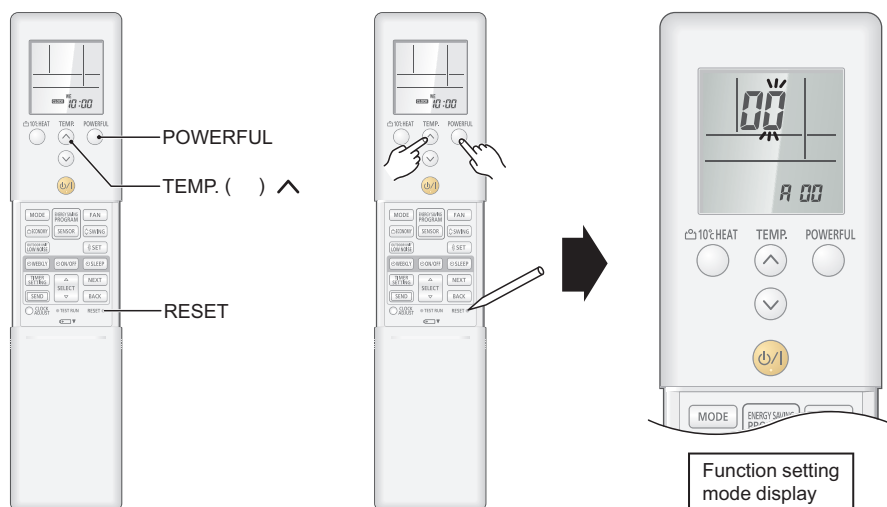

3. Select the function number by pressing the ^ or the v buttons. Each time the 10 °C HEAT button is pressed, it switches between the right digit and the left digit.



4. Proceed to the setting number by pressing the POWERFUL button. (To return to the function number selection, press the POWERFUL button again.)



5. Select the function number by pressing the ^ or the v button. Each time the 10 °C HEAT button is pressed, it switches between the right digit and the left digit.

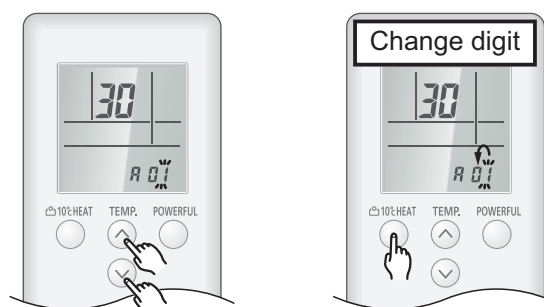

- Press the MODE button once to transmit the function mode information.

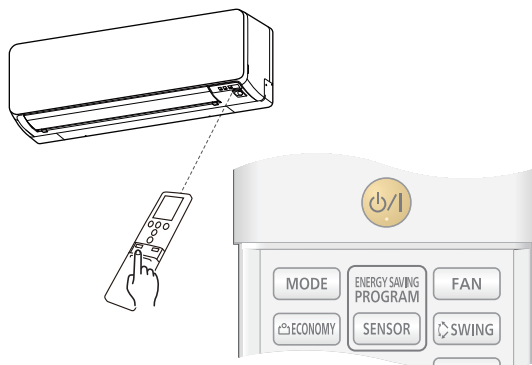

- Press the ϕ/I button once to transmit the function setting information. 2 short beeps will be emitted from the indoor unit when the signal is received correctly. If wrong code is set, no beep sound will be emitted.

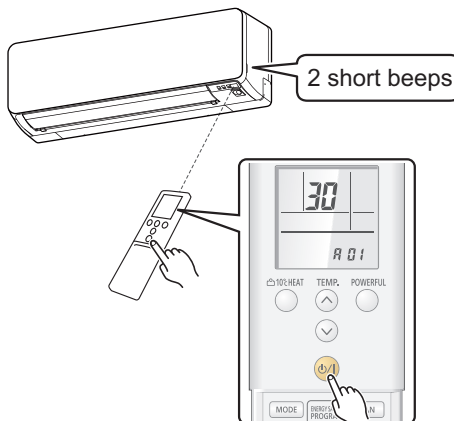

NOTE: Press ϕ/I button within 30 seconds after pressing MODE button.

For the function details, refer to Chapter 15-6. "[Function details](#)" on page 255.

- Exit the function setting mode by pressing the RESET button.

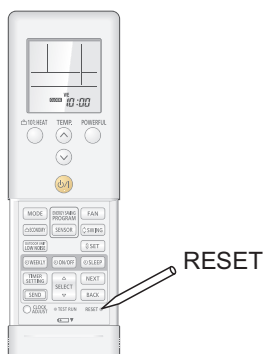

● Setting up each indoor unit

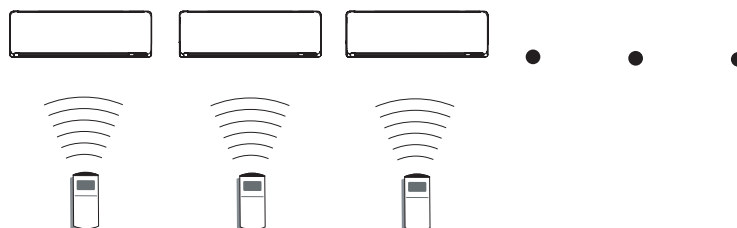

Repeat step from 1. to 8. to set up each indoor unit. If the custom code is other than "R", steps from 1. to 2. and 8. need to be performed.

● Resetting the power after setting up all indoor units

Important:

- If the reset is not performed, function cannot be read correctly.
- After all the functions have been set, the circuit breaker needs to be switched off for at least 2 minutes.
 - After the 2 minutes has passed, power can be restored.
 - The set function is stored in the PCB and will remain in memory even when the power of indoor unit is turned off.
However setting function is effective after disconnecting the power supply and then reconnecting it.
- Record the latest configuration of the indoor unit function setting on a label, and put the label on the unit so it can be used for after-sales service operations.

Once the RESET button is pressed on the remote controller, the operation mode will be set to the AUTO MODE.

Adjust the operation mode to either cooling or heating before starting the operation of the air conditioner.

NOTE: If custom code other than "F" is set, the remote control must be set accordingly to the indoor unit setting.

● Remote controller custom code setting

Custom code setting of wireless remote controller needs to be same as the setting of the indoor unit. When you change the custom code setting of the wireless remote controller, do as follows:

1. Press the START/STOP button until only the clock is displayed on the display.



2. Press the MODE button for at least 5 seconds to display the current custom code (initially set to A).



3. Press the TEMP. “ ^ ” or the “ v ” button to change the custom code between A → b → c → d.

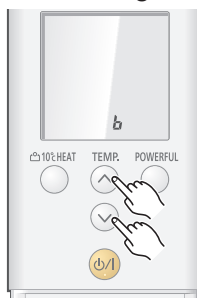

4. Press the MODE button again to return to the clock display. The custom code will be changed.



- If no buttons are pressed within 30 seconds after the custom code is displayed, the system returns to the original clock display. In this case, start again from step 1.
- The air conditioner custom code is set to A prior to shipment.
- If you do not know the air conditioner custom code setting, try each of the custom codes (A → b → c → d) until you find the code which operates the air conditioner.

■ AR-RMB1E(-B) (for Wall mounted type KMCG and KMCG-B)

● Button name and function

During address setting mode, indoor unit reject the any operation command from remote controller.

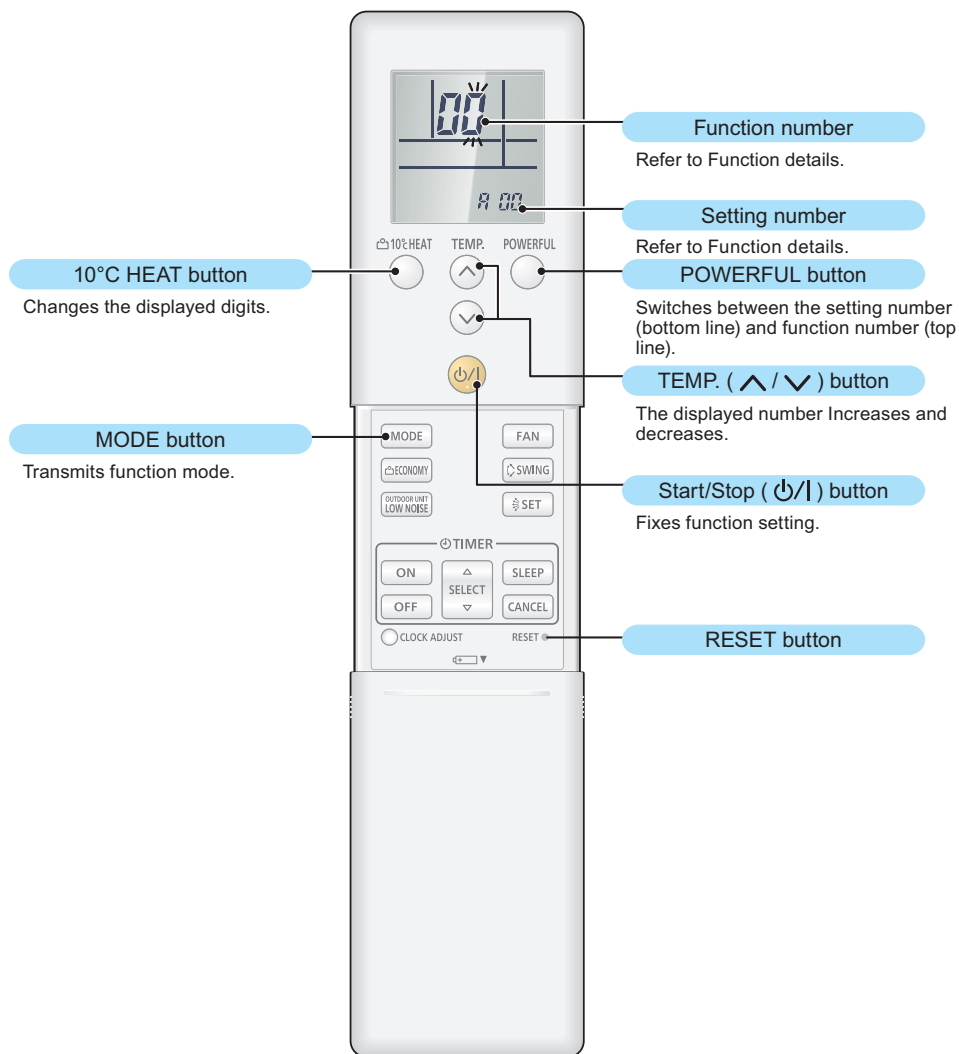

● Function setting procedure

1. Connect the power supply of the outdoor unit.
2. To enter the function setting mode, while holding down the POWERFUL and SET TEMP. \wedge buttons, press the RESET button.

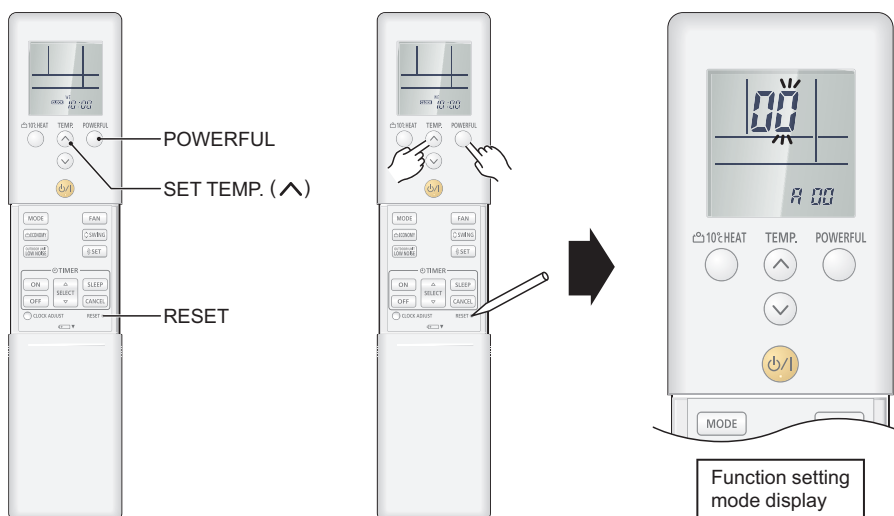

3. Select the function number by pressing the \wedge or the \vee buttons. Each time the 10°C HEAT button is pressed, it switches between the right digit and the left digit.



4. Proceed to the setting number by pressing the POWERFUL button. (To return to the function number selection, press the POWERFUL button again.)



5. Select the function number by pressing the \wedge or the \vee button. Each time the 10°C HEAT button is pressed, it switches between the right digit and the left digit.

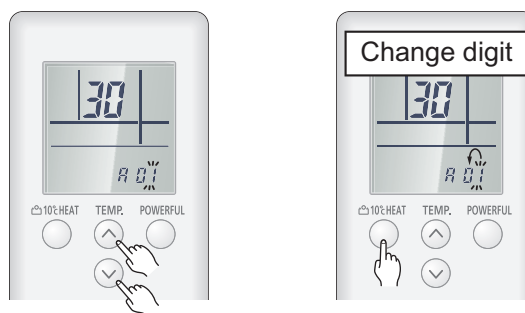

6. Press the MODE button once to transmit the function mode information.

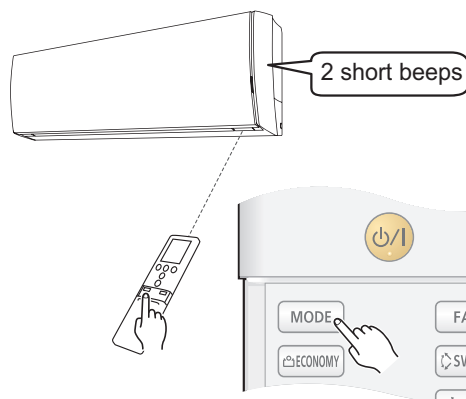

7. Press the ϕ /I button once to transmit the function setting information. 2 short beeps will be emitted from the indoor unit when the signal is received correctly. If wrong code is set, no beep sound will be emitted.

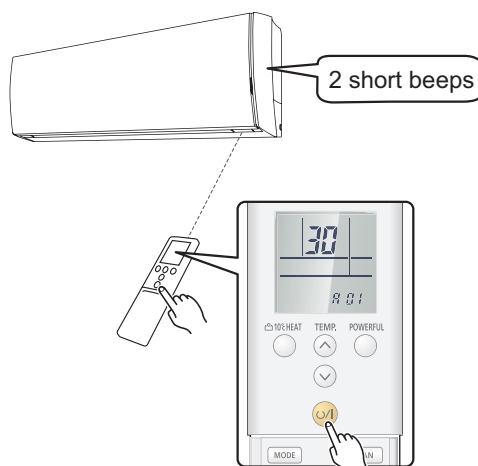

NOTE: Press ϕ /I button within 30 seconds after pressing MODE button.

For the function details, refer to Chapter 15-6. "[Function details](#)" on page 255.

8. Exit the function setting mode by pressing the RESET button.

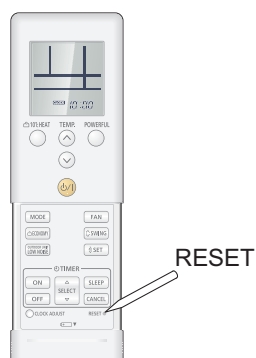

● Setting up each indoor unit

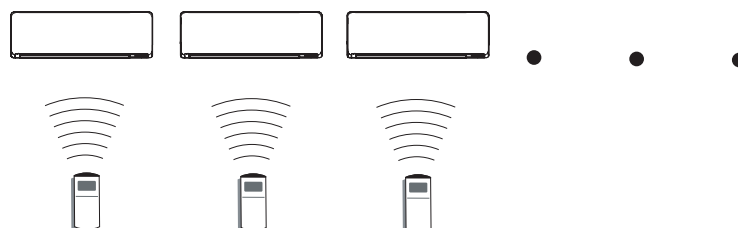

Repeat step from 1. to 8. to set up each indoor unit. If the custom code is other than "H", steps from 1. to 2. and 8. need to be performed.

● Resetting the power after setting up all indoor units

Important:

- If the reset is not performed, function cannot be read correctly.
- After all the functions have been set, the circuit breaker needs to be switched off for at least 2 minutes.
 - After the 2 minutes has passed, power can be restored.
 - The set function is stored in the PCB and will remain in memory even when the power of indoor unit is turned off.
However setting function is effective after disconnecting the power supply and then reconnecting it.
- Record the latest configuration of the indoor unit function setting on a label, and put the label on the unit so it can be used for after-sales service operations.

Once the RESET button is pressed on the remote controller, the operation mode will be set to the AUTO MODE.

Adjust the operation mode to either cooling or heating before starting the operation of the air conditioner.

NOTE: If custom code other than "F" is set, the remote control must be set accordingly to the indoor unit setting.

● Remote controller custom code setting

Custom code setting of wireless remote controller needs to be same as the setting of the indoor unit. When you change the custom code setting of the wireless remote controller, do as follows:

1. Press the START/STOP button until only the clock is displayed on the display.



2. Press the MODE button for at least 5 seconds to display the current custom code (initially set to A).



3. Press the SET TEMP. “ ^ ” or the “ √ ” button to change the custom code between A → b → c → d.



4. Press the MODE button again to return to the clock display. The custom code will be changed.



- If no buttons are pressed within 30 seconds after the custom code is displayed, the system returns to the original clock display. In this case, start again from step 1.
- The air conditioner custom code is set to A prior to shipment.
- If you do not know the air conditioner custom code setting, try each of the custom codes (A → b → c → d) until you find the code which operates the air conditioner.

■ UTY-LNTY (for Compact cassette type) or AR-REJ1E (included in UTY-LBTYM for Duct type)

● Button name and function

During address setting mode, indoor unit reject the any operation command from remote controller.

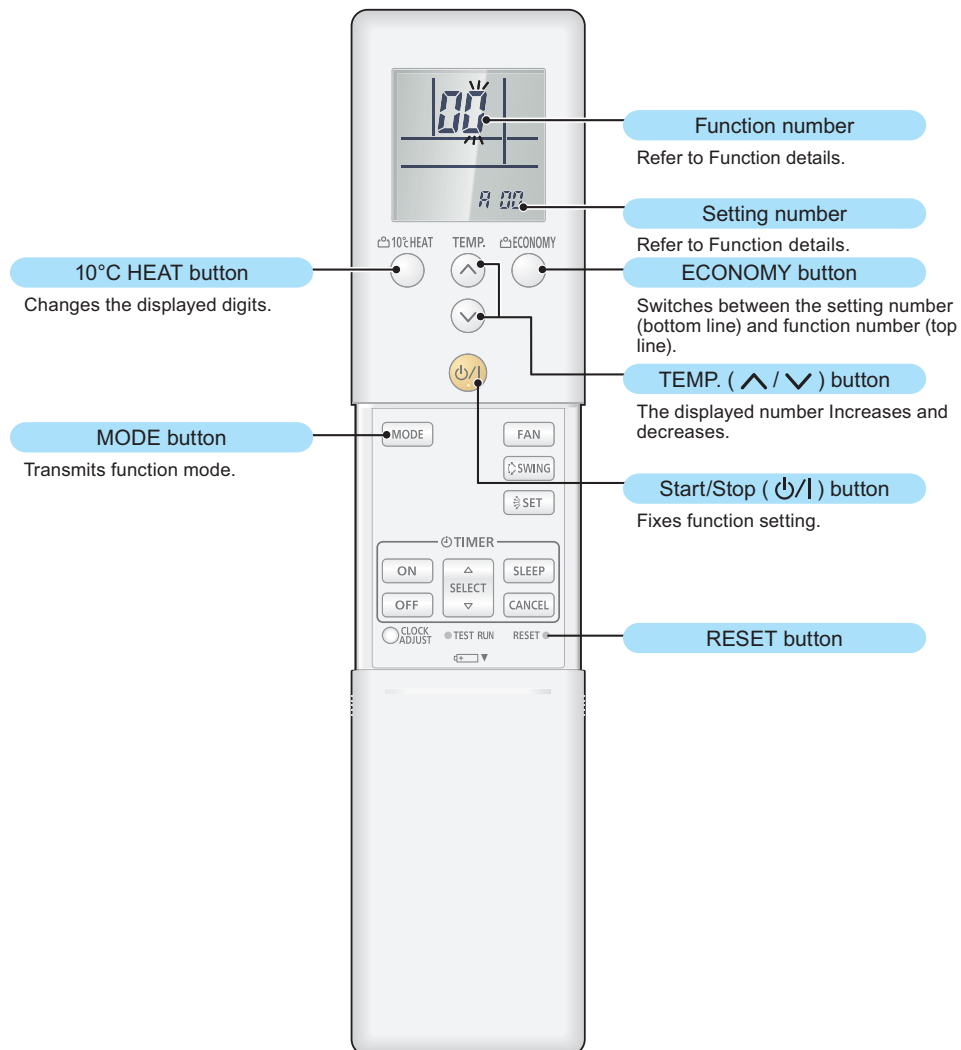

● Function setting procedure

1. Connect the power supply of the outdoor unit.
2. To enter the function setting mode, while holding down the ECONOMY and SET TEMP. (^) buttons, press the RESET button.

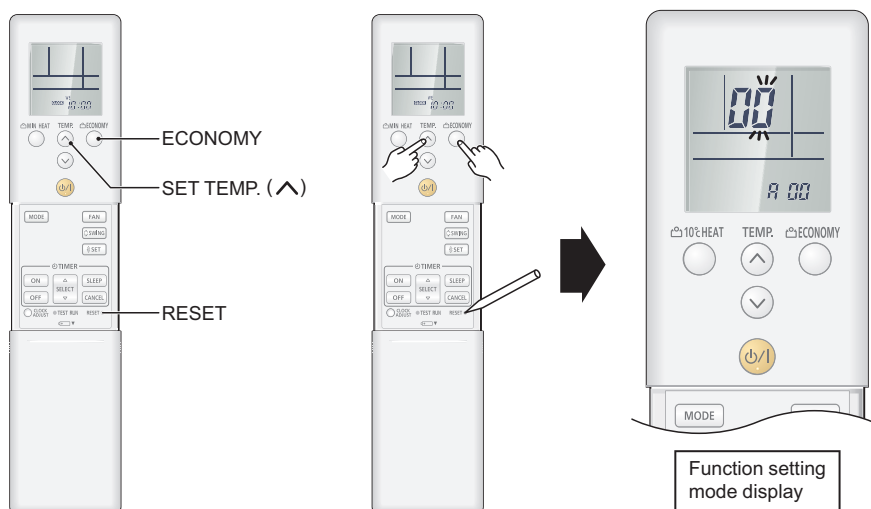

3. Select the function number by pressing the \wedge or the \vee buttons. Each time the 10°C HEAT button is pressed, it switches between the right digit and the left digit.



4. Proceed to the setting number by pressing the ECONOMY button. (To return to the function number selection, press the ECONOMY button again.)



5. Select the function number by pressing the \wedge or the \vee button. Each time the 10°C HEAT button is pressed, it switches between the right digit and the left digit.

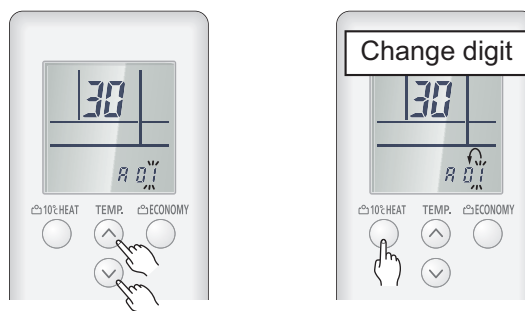

6. Press the MODE button once to transmit the function mode information.

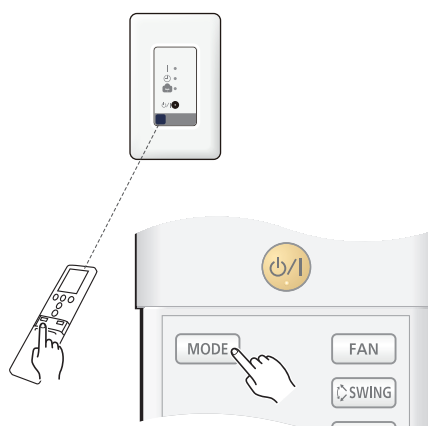

7. Press the ϕ /I button once to transmit the function setting information. 1 short beep will be emitted from the indoor unit or the IR receiver when the signal is received correctly. If wrong code is set, no beep sound will be emitted.

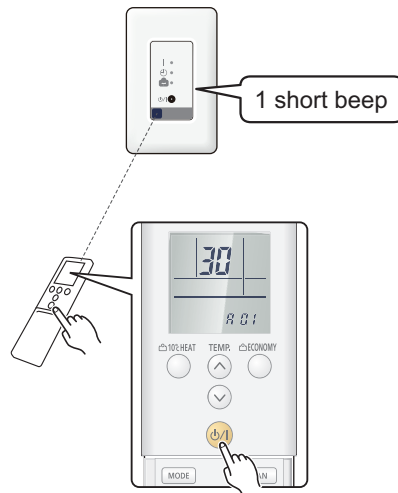

NOTE: Press ϕ /I button within 30 seconds after pressing MODE button.

For the function details, refer to Chapter 15-6. "[Function details](#)" on page 255.

8. Exit the function setting mode by pressing the RESET button.

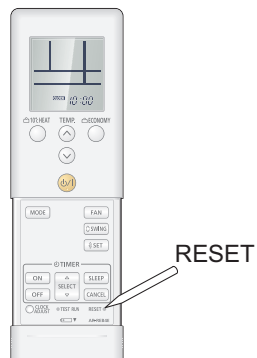

● Setting up each indoor unit

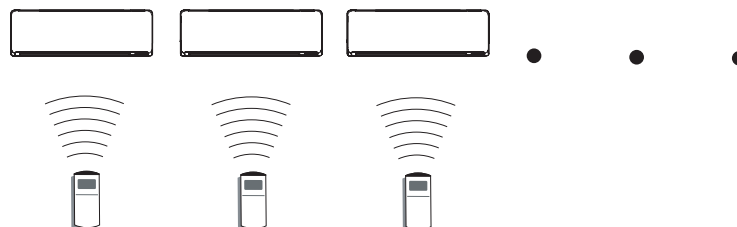

Repeat step from 1. to 8. to set up each indoor unit. If the custom code is other than "A", steps from 1. to 2. and 8. need to be performed.

● Resetting the power after setting up all indoor units

Important:

- If the reset is not performed, function cannot be read correctly.
- After all the functions have been set, the circuit breaker needs to be switched off for at least 2 minutes.
 - After the 2 minutes has passed, power can be restored.
 - The set function is stored in the PCB and will remain in memory even when the power of indoor unit is turned off. However setting function is effective after disconnecting the power supply and then reconnecting it.
- Record the latest configuration of the indoor unit function setting on a label, and put the label on the unit so it can be used for after-sales service operations.

Once the RESET button is pressed on the remote controller, the operation mode will be set to the AUTO MODE.

Adjust the operation mode to either cooling or heating before starting the operation of the air conditioner.

NOTE: If custom code other than "A" is set, the remote control must be set accordingly to the indoor unit setting.

● Remote controller custom code setting

Custom code setting of wireless remote controller needs to be same as the setting of the indoor unit. When you change the custom code setting of the wireless remote controller, do as follows:

1. Press the START/STOP button until only the clock is displayed on the display.

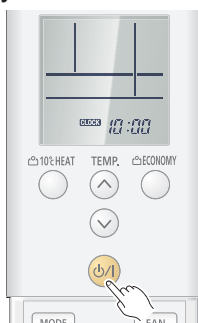

2. Press the MODE button for at least 5 seconds to display the current custom code (initially set to A).
3. Press the SET TEMP. “ ^ ” or the “ v ” button to change the custom code between A → B → C → D.

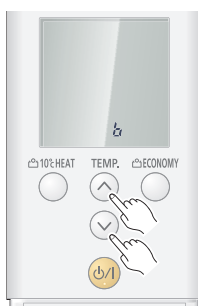

4. Press the MODE button again to return to the clock display. The custom code will be changed.



- If no buttons are pressed within 30 seconds after the custom code is displayed, the system returns to the original clock display. In this case, start again from step 1.
- The air conditioner custom code is set to A prior to shipment.
- If you do not know the air conditioner custom code setting, try each of the custom codes (A → B → C → D) until you find the code which operates the air conditioner.

■ AR-RPF4E (for Wall mounted type KNCA)

The function number and the associated setting value are displayed on the LCD of the remote controller. Follow the instructions written in the local setup procedure supplied with the remote controller, and select appropriate setting according to the installation environment.

Before connecting the power supply of the indoor unit, reconfirm following items:

- Piping air tight test and vacuuming have been performed firmly.
- There is no wiring mistake.

Then, connect the power supply of the indoor unit.

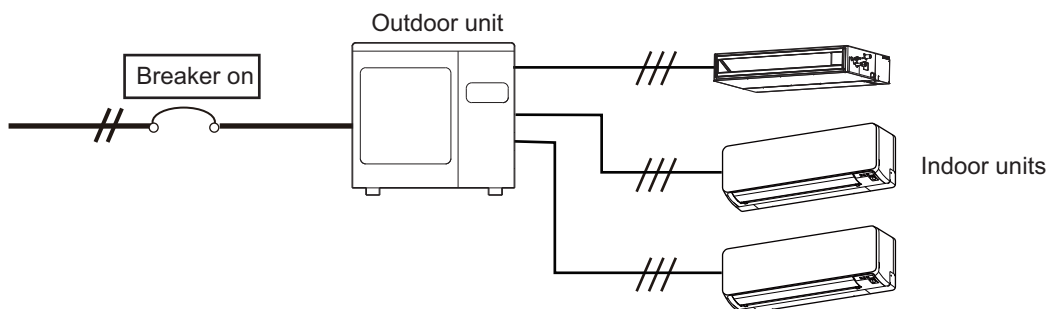

Entering function setting mode:

While pressing the FAN SPEED button and TEMP./SELECT (^) button simultaneously, press the RESET button to enter the function setting mode.

STEP 1: Setting the remote controller custom code

Use the following steps to select the custom code of the remote controller. (Note that the air conditioner cannot receive a custom code if the air conditioner has not been set for the custom code.)

The custom codes that are set through this process are applicable only to the signal in the function setting.

For details on how to set the custom codes through the normal process, refer to "[Custom code setting on AR-RPF4E](#)" on page 234.

1. Press the TEMP./SELECT (^) (v) buttons to change the custom code between $\text{A} \rightarrow \text{b} \rightarrow \text{c} \rightarrow \text{d}$. Match the code on the display to the air conditioner custom code. (Initially set to A .) If the custom code does not need to be selected, press the MODE button, and proceed to **STEP 2**.
2. Press the MODE button to accept the custom code, and proceed to **STEP 2**.



NOTES:

- The air conditioner custom code is set to A prior to shipment.
- The remote controller resets to custom code A when the batteries on the remote controller are replaced. If you use a custom code other than code A , reset the custom code after replacing the batteries.
- If you do not know the air conditioner custom code setting, try each of the custom codes ($\text{A} \rightarrow \text{b} \rightarrow \text{c} \rightarrow \text{d}$) until you find the code that operates the air conditioner.

STEP 2: Selecting the function number and setting value

1. Press the TEMP./SELECT (^) (v) buttons to select the function number. To switch between the left and right digits, press the MODE button.
2. Press the FAN SPEED button to proceed the setting value. To return the function number selection, press the FAN SPEED button again.
3. Press the TEMP./SELECT (^) (v) buttons to select the setting value. To switch between the left and right digits, press the MODE button.
4. Press the TIMER button, and when the indoor unit beeps, press the ϕ /I (START/STOP) button to confirm the settings.
5. Press the RESET button to cancel the function setting mode.
6. After completing the function setting, be sure to disconnect the power supply and then reconnect it.

Function number



Setting value

**⚠ CAUTION**

- After disconnecting the power supply, wait 30 seconds or more before reconnecting it. The function setting will not become active unless the power supply is disconnected and then reconnected.
- When using a custom code other than \mathcal{R} , press RESET and then press and hold MODE again for 5 seconds or more to set the custom code.

● Custom code setting on AR-RPF4E

To interconnect the air conditioner and the wireless remote controller, assignment of the custom code for the wireless remote controller is required.

NOTE: Air conditioner cannot receive a signal if the air conditioner has not been set for the custom code.

When 2 or more air conditioners are installed in a room, and the remote controller is operating an air conditioner other than the one you wish to set, change the custom code of the remote controller to operate only the air conditioner you wish to set. (4 selections possible.)

Confirm the setting of the remote controller custom code and the function setting. If these do not match, the remote controller cannot be used to operate for the air conditioner.

1. Press the $\phi/1$ (START/STOP) button until the indicators on the remote controller turn off.
2. Press the MODE button for at least 5 seconds to display the current custom code. (Initially set to \overline{A} .)
3. Press the TEMP./SELECT (\wedge) (\vee) buttons to change the custom code between $\overline{A} \rightarrow \overline{b} \rightarrow \overline{c} \rightarrow \overline{d}$. Match the code on the display to the air conditioner custom code. (Initially set to \overline{A} .)
4. Press the MODE button again to return to the original display. The custom code will be changed.



To set custom code \overline{b} , \overline{c} , or \overline{d} , perform same procedures for each code.

NOTES:

- If no button is pressed within 30 seconds after the custom code is displayed, the system returns to the original display. In this case, start again from step 1.
- The air conditioner custom code is set to \overline{A} prior to shipment. To change the custom code, contact your retailer.
- If you do not know the assigned code for the air conditioner, try each of the custom code ($\overline{A} \rightarrow \overline{b} \rightarrow \overline{c} \rightarrow \overline{d}$) until you find the code which operates the air conditioner.

15-4. Indoor unit (setting by wired remote controller)

- The function settings of the control of the indoor unit can be changed by this procedure according to the installation conditions. Incorrect settings can cause the indoor unit malfunction.
- After the power is turned on, perform the “Function setting” according to the installation conditions using the remote controller.
- The settings may be selected between the following two: Function number or Setting number.
- Settings will not be changed if invalid numbers or setting numbers are selected.
- This function cannot be used on the secondary units.

■ Preparation

Before connecting the power supply of the indoor unit, reconfirm following items:

- Piping air tightness test and vacuuming have been performed firmly.
- There is no wiring mistake. Then, connect the power supply of the indoor unit.

■ UTY-RNNYM

● Button name and function

During address setting mode, indoor unit reject the any operation command from remote controller.

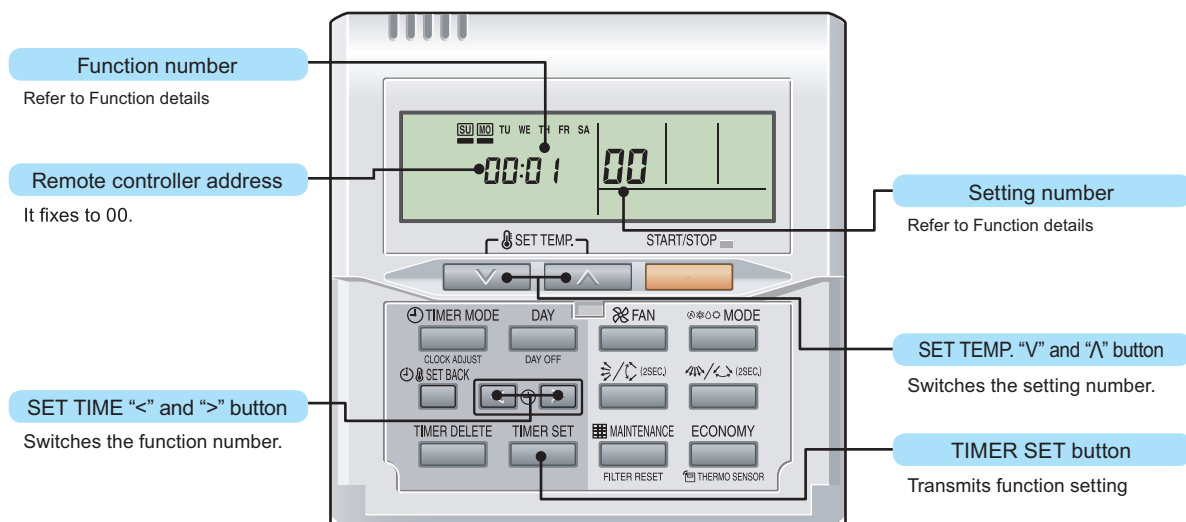

● Function setting procedure

1. Connect the power supply of the outdoor unit.
2. Switch to the function setting mode.

To enter the function setting mode, hold down the 3 buttons of SET TEMP. ∇ , SET TEMP. \blacktriangle , and FAN at the same time for 5 seconds or longer.

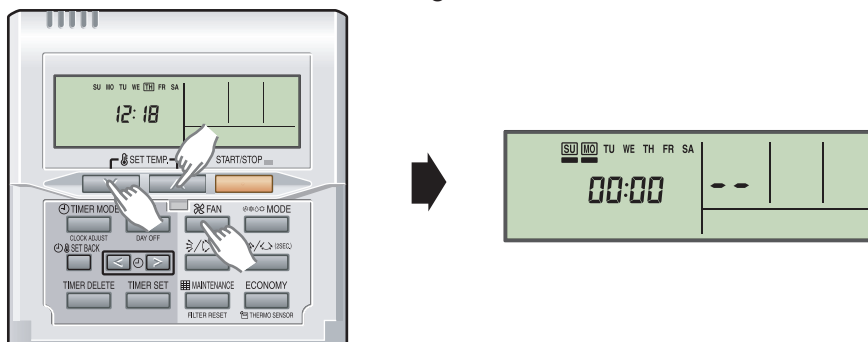

3. Select the function number by pressing the SET TIME < or the SET TIME > button.

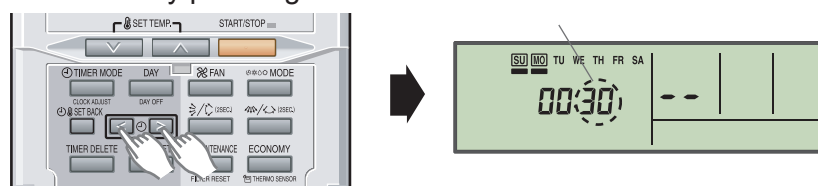

4. Select the setting number by pressing the SET TEMP. \blacktriangle or the SET TEMP. ∇ button. The display flashes during setting number selection.

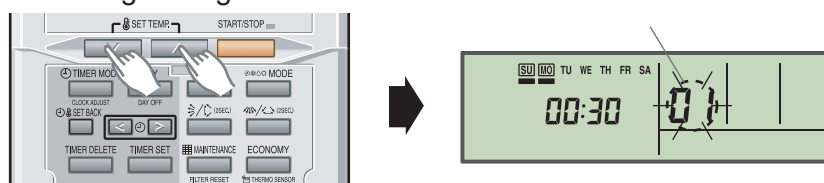

5. Confirm the setting by pressing the TIMER SET button.
The data will be transferred to the indoor unit.

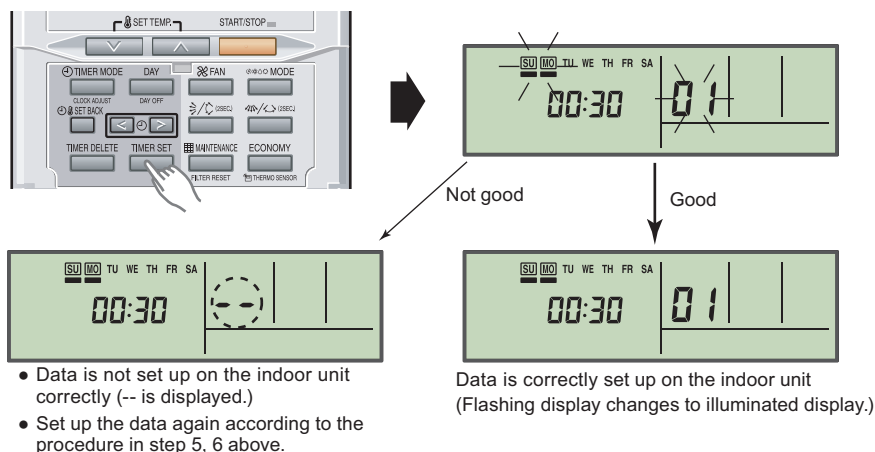

Function details: Refer to Chapter 15-6. "Function details" on page 255.

6. Exit the function setting mode by holding 3 buttons of SET TEMP. ∇ , SET TEMP. \wedge and FAN at the same time.

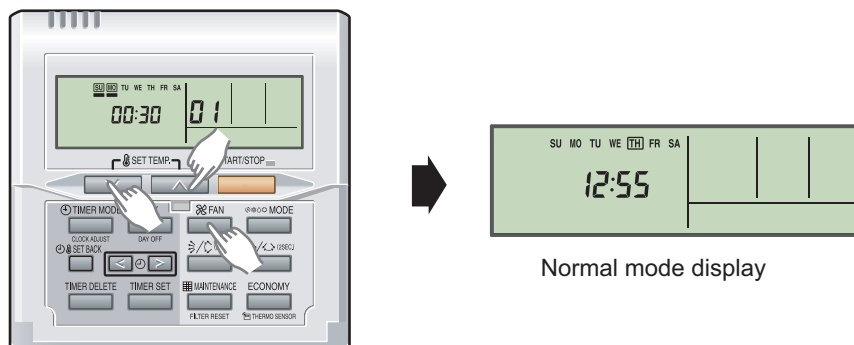

If no button is pressed within 60 seconds after buttons mentioned above are pressed, it will automatically exit the function setting mode.

If you exit the function setting mode unintentionally during setting, enter the mode again according to the procedure in step 2.

● Setting up each indoor unit

Repeat the procedures from step 1 to 6, and set up the indoor units requiring function setting.

● Resetting the power after setting up function of all indoor units

NOTES:

- If the reset is not performed, function cannot be read correctly.
- After all the functions have been set, the circuit breaker needs to be switched off for at least 2 minutes.
 - After the 2 minutes has passed, power can be restored.
 - The set function is stored in the PCB and will remain in memory even when the power of indoor unit is turned off.
However setting function is effective after disconnecting the power supply and then reconnecting it.
- Record the latest configuration of the indoor unit function setting on a label, and put the label on the unit so it can be used for after-sales service operations.

■ UTY-RLRY

● Setting procedure by using wired remote controller

The function number and the associated setting value are displayed on the LCD of the remote controller. Follow the instructions written in the local setup procedure supplied with the remote controller, and select appropriate setting according to the installation environment.

Before connecting the power supply of the indoor unit, reconfirm following items:

- Piping air tightness test and vacuuming have been performed firmly.
 - There is no wiring mistake.
1. Connect the power supply.
 2. To activate the address setting mode, hold down the three buttons of "MENU", "<", and "ENTER" at the same time for 2 seconds or longer. Menu 2 setting screen is displayed.

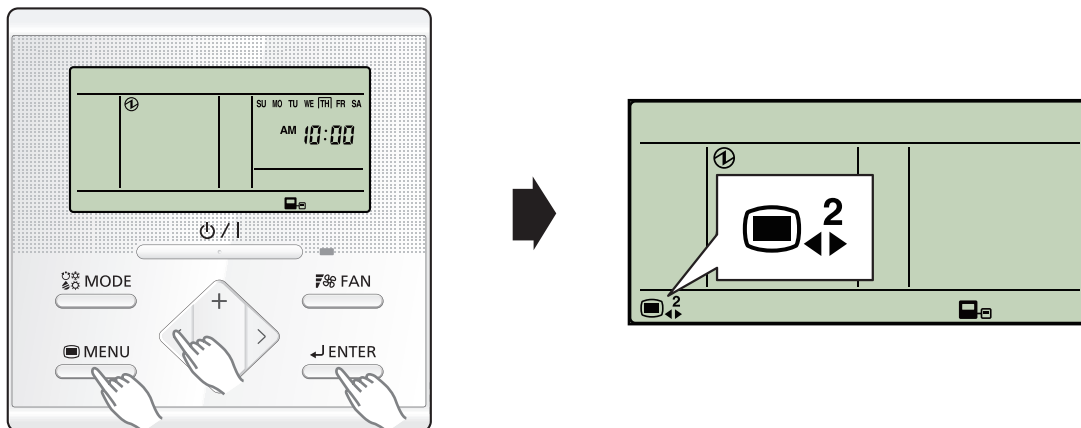

3. Select the "13" in Menu 2 settings. Then press the "ENTER" button.

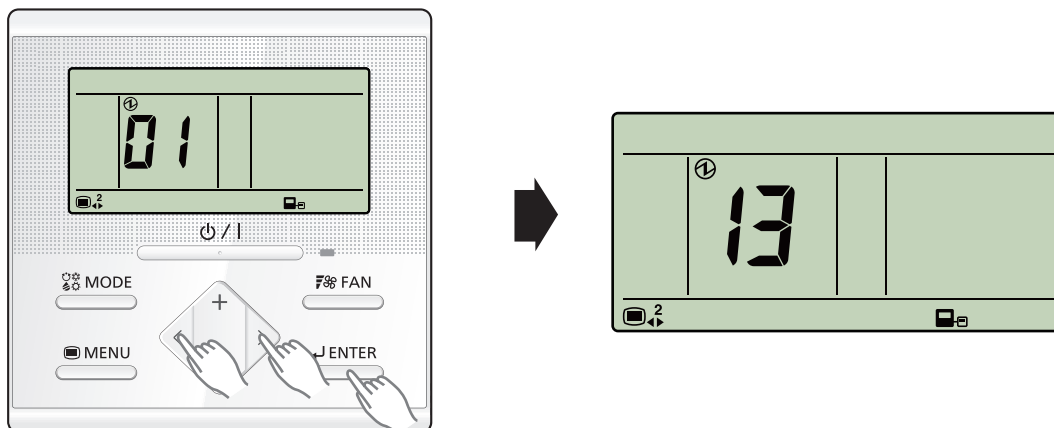

4. Pressing the "+" or "-" button, select a remote controller address (select the indoor unit you want to operate). Then press the "ENTER" button.

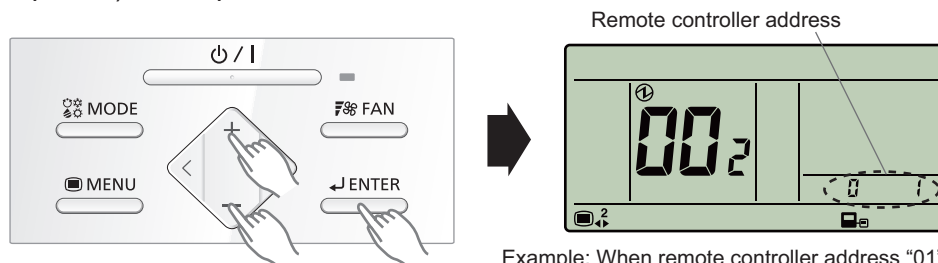

Example: When remote controller address "01" is selected.

5. Pressing the "+" or "-" button, to select the function number. Then press the "ENTER" button.

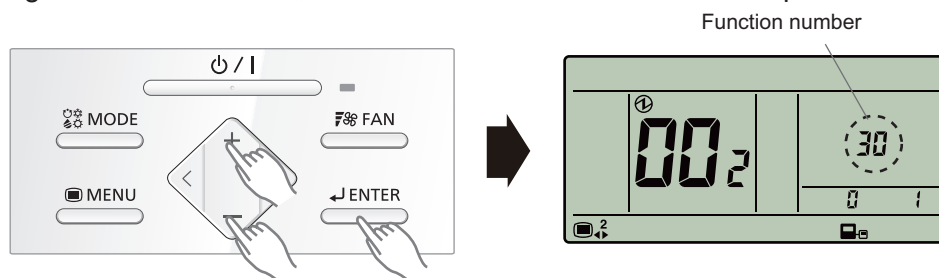

6. Pressing the "+" or "-" button, to select the setting number. Then press the "ENTER" button.

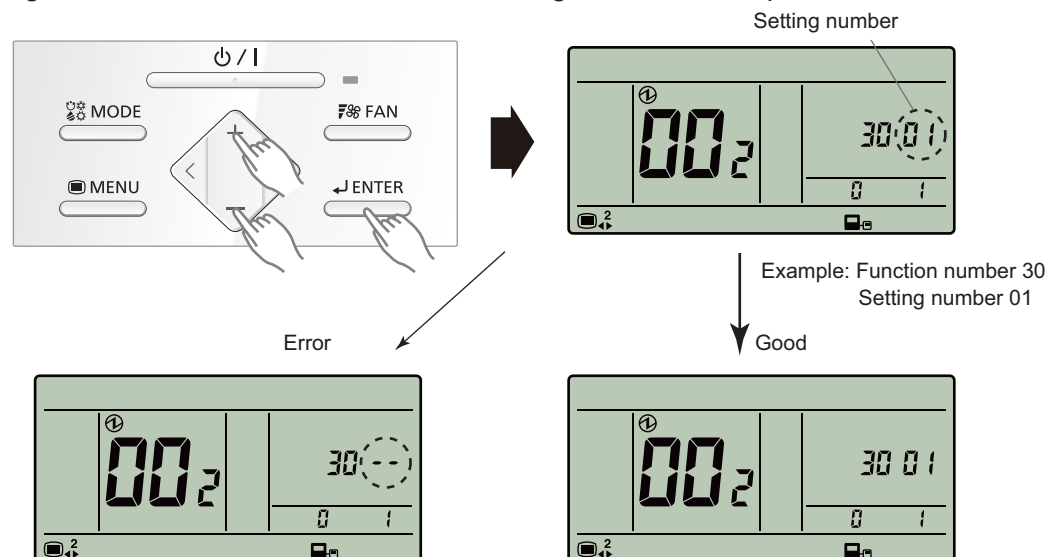

• When the data was not set up on the indoor unit ("--" is displayed.)

• Set up the data again.

• When the data was normally set up on the indoor unit.

Pressing the "ENTER" button to return to the address selection screen.

If setting has been completed, pressing the "MENU" button to return to the Menu 2 item selection screen.

● Setting up each indoor unit

Repeat the procedure from step 1 to 6, and set up the indoor units requiring function setting.

● Resetting the power after setting up function of all indoor units

NOTES:

- If the reset is not performed, function cannot be read correctly.
- After all the functions have been set, the circuit breaker needs to be switched off for at least 2 minutes.
 - After the 2 minutes has passed, power can be restored.
 - The set function is stored in the PCB and will remain in memory even when the power of indoor unit is turned off. However setting function is effective after disconnecting the power supply and then reconnecting it.
- Record the latest configuration of the indoor unit function setting on a label, and put the label on the unit so it can be used for after-sales service operations.

■ UTY-RVNYM

● Function setting procedure

1. Connect the power supply of the outdoor unit.
2. Switch to the function setting mode.

When [Menu button] is pressed twice while “Monitor” screen is displayed, it switches to the “Submenu” screen. If [Menu button] is pressed while the “Submenu” screen is displayed, the display returns to the “Monitor” screen.

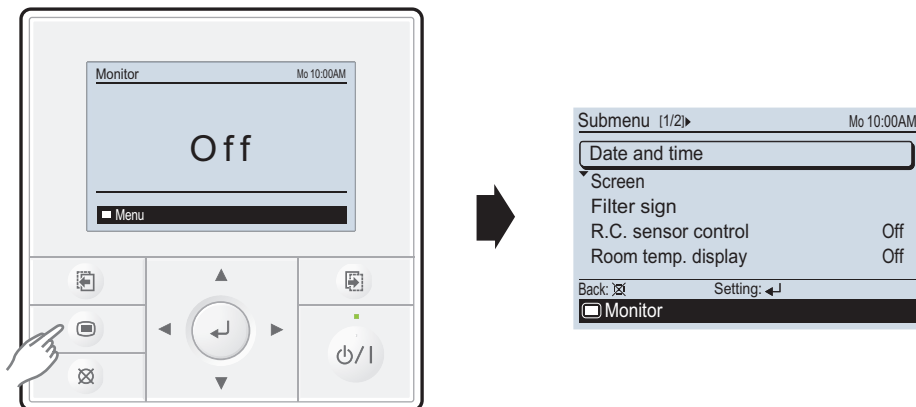

Press the [Screen switch button (Left)] and [Screen switch button (Right)] simultaneously for 5 seconds to switch to “Service” screen.

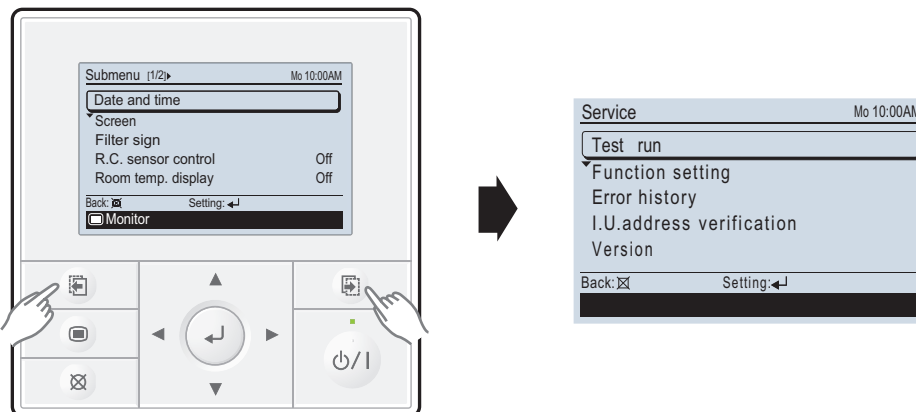

Select [Function setting] with pressing the [Cursor button (Up/Down)], and press the [Enter button].

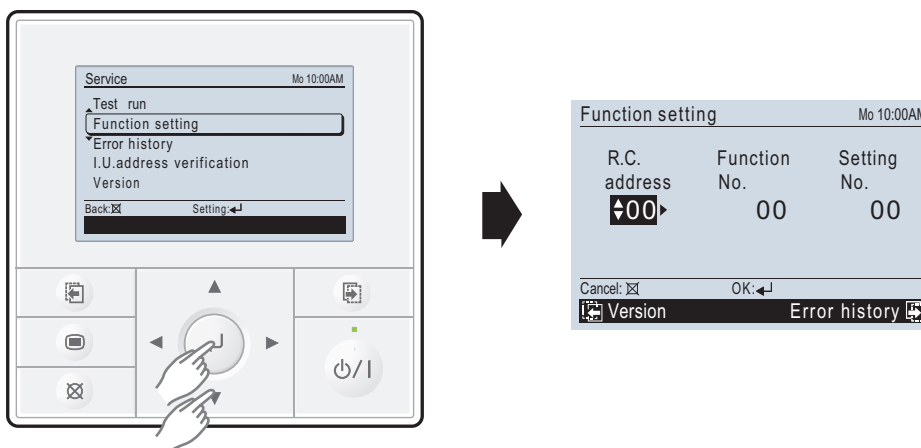

3. Select the [Function No.] with pressing the [Cursor button (Left/Right)], and select the Function No. to be set with pressing the [Cursor button (Up/Down)].

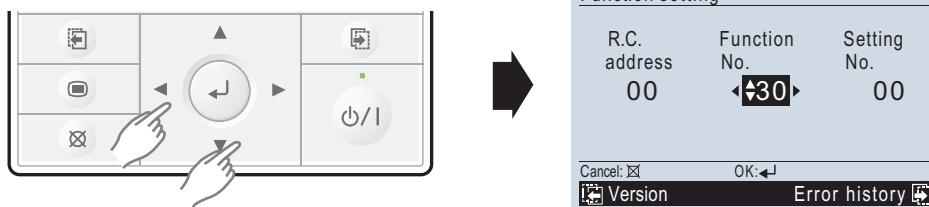

4. Select the [Setting No.] with pressing the [Cursor button (Left/Right)], and select the Setting No. to be set with pressing the [Cursor button (Up/Down)].

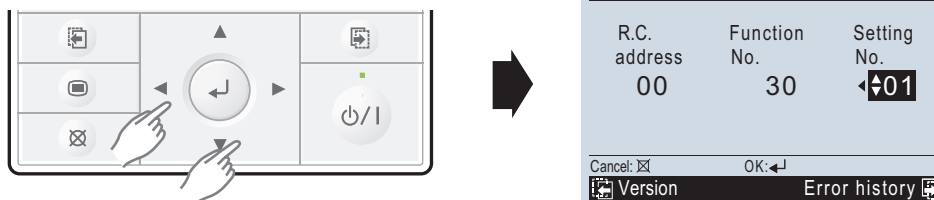

5. Pressing the [Enter button], confirm the setting. The data will be transferred to the indoor unit.

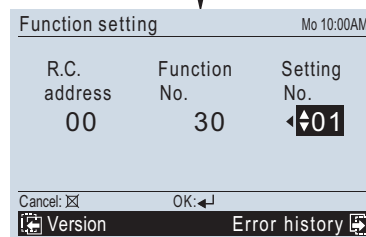
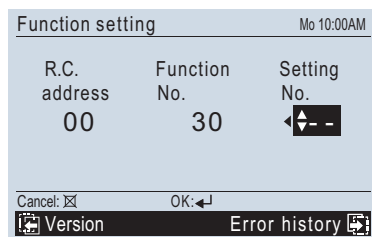
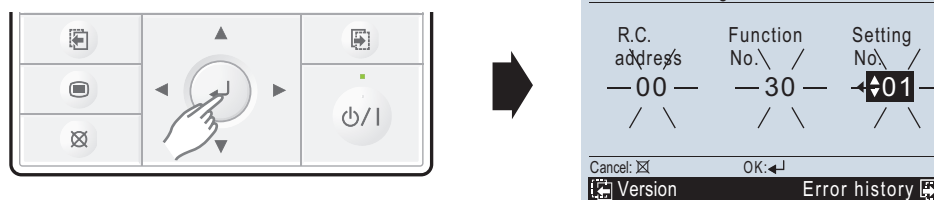

Function details: Refer to Chapter 15-6. "Function details" on page 255.

6. When [Cancel button] is pressed twice while “Function setting” screen is displayed, it switches to the “Submenu” screen.

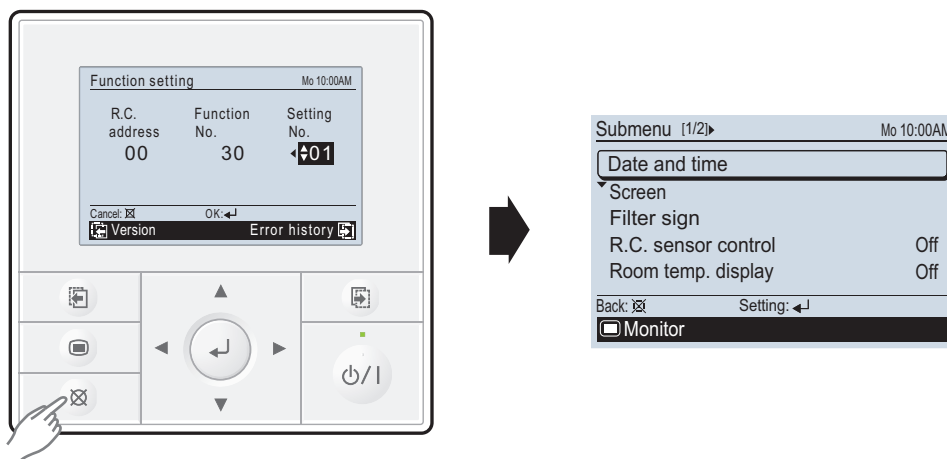

If no button is pressed within 60 seconds after buttons mentioned above are pressed, it will automatically exit the function setting mode.

If you exit the function setting mode unintentionally during setting, enter the mode again according to the procedure in step 2.

● Setting up each indoor unit

Repeat the procedures from step 1 to 6, and set up the indoor units requiring function setting.

● Resetting the power after setting up function of all indoor units

NOTES:

- If the reset is not performed, function cannot be read correctly.
- After all the functions have been set, the circuit breaker needs to be switched off for at least 2 minutes.
 - After the 2 minutes has passed, power can be restored.
 - The set function is stored in the PCB and will remain in memory even when the power of indoor unit is turned off.

However setting function is effective after disconnecting the power supply and then reconnecting it.
- Record the latest configuration of the indoor unit function setting on a label, and put the label on the unit so it can be used for after-sales service operations.

■ UTY-RNRYZ*

● Setting procedure by using wired remote controller

The function number and the associated setting value are displayed on the LCD of the remote controller. Follow the instructions written in the local setup procedure supplied with the remote controller, and select appropriate setting according to the installation environment.

Before connecting the power supply of the indoor unit, reconfirm following items:

- Piping air tightness test and vacuuming have been performed firmly.
 - There is no wiring mistake.
1. Connect the power supply.
 2. When the “Function Setting” on the “Maintenance” screen is touched, the “Installer Password Verification” screen is displayed. After enter the installer password, and touch the “OK”, “Function Setting” screen is displayed.

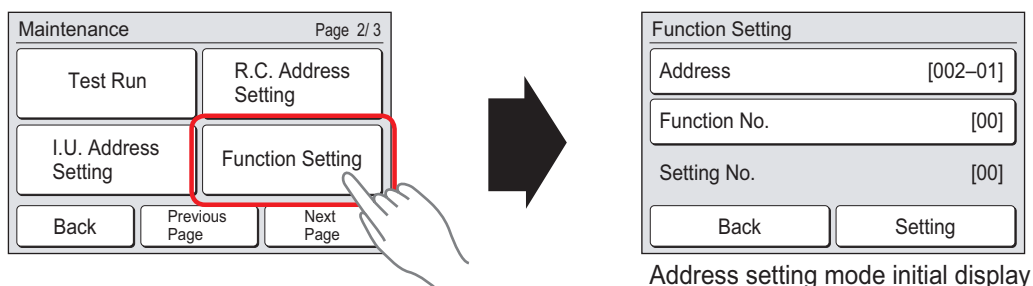

3. Touch the “Address” on the “Function Setting” screen.

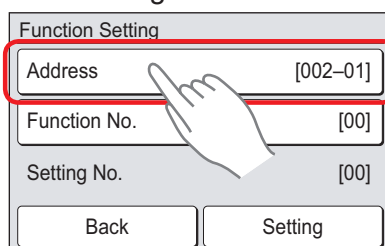

4. “Address” screen is displayed. Select the address of the indoor unit whose function number is be set by touching ▲ or ▼. When setting at all the indoor units, touch “All”.

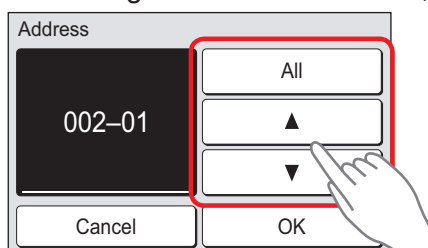

When the “OK” is touched, the display returns to the “Function Setting” screen.

5. Touch the “Function No.” on the “Function Setting” screen.

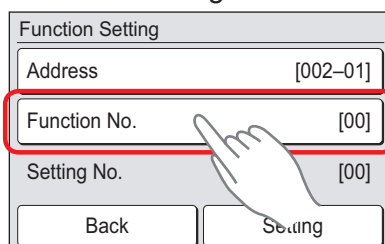

6. "Function No." screen is displayed. Set the "Function No." with ▲ or ▼.

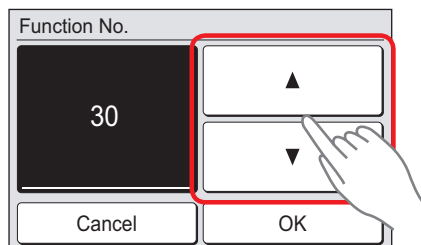

When the "OK" is touched, the display returns to the "Function Setting" screen.

7. Touch the "Function No." on the "Function Setting" screen.

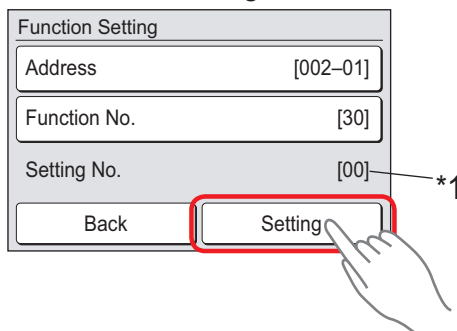

NOTE: *1: When "All" is chosen by "5", and different set up "Setting No." from two or more indoor units, "-" is displayed on "Setting No.".

8. Setting screen of "Setting No." is displayed. Set the "Function No." with ▲ or ▼.

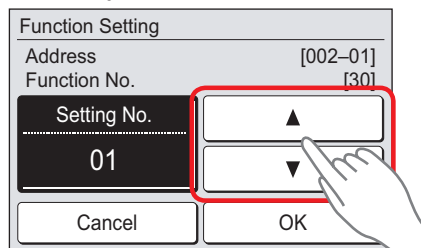

Example: Function number: 30, Setting Number: 01

When the "OK" is touched, the "Function Setting" verification screen is displayed.

9. Touch the "Yes" of the verification screen.

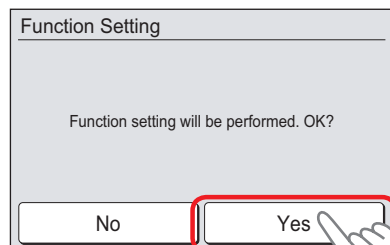

In case of "OK"

In case of "ERROR"

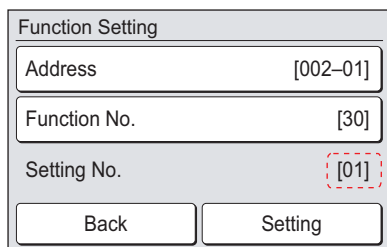

When the data was normally set up on the indoor unit

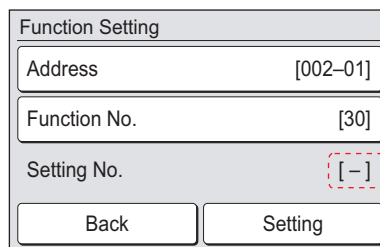

When the data was not set up on the indoor unit ([-] is displayed.), set up the data again according to the procedure in step 4 to 7 above

10. When the "Back" on the "Function Setting" screen is touched, the display returns to the "Maintenance" screen.

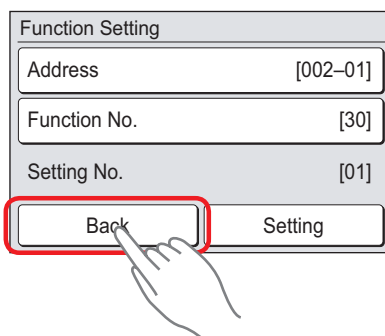

● Setting up each indoor unit

Repeat the procedure from step 1 to 6, and set up the indoor units requiring function setting.

● Resetting the power after setting up function of all indoor units

NOTES:

- If the reset is not performed, function cannot be read correctly.
- After all the functions have been set, the circuit breaker needs to be switched off for at least 2 minutes.
 - After the 2 minutes has passed, power can be restored.
 - The set function is stored in the PCB and will remain in memory even when the power of indoor unit is turned off. However setting function is effective after disconnecting the power supply and then reconnecting it.
- Record the latest configuration of the indoor unit function setting on a label, and put the label on the unit so it can be used for after-sales service operations.

■ UTY-RVRY

● Function setting procedure

1. Tap the menu as shown below.



2. Tap "Address" on the Function Setting screen. Enter the Admin password. Enter the Installer password.

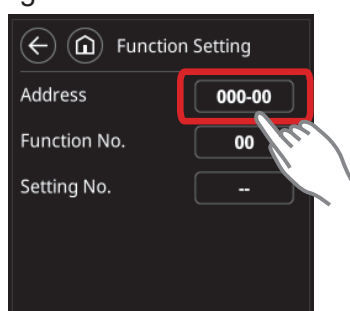

3. Pull-down window of indoor unit address is displayed. Select the address of the indoor unit whose function number is to be set.

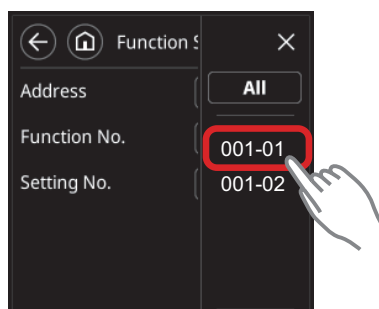

4. Tap "Function No." on the Function Setting screen.

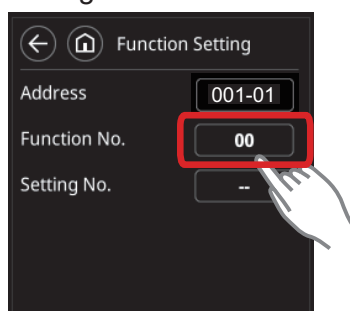

5. Pull-down window of Function No. is displayed. Set the Function No to be set.

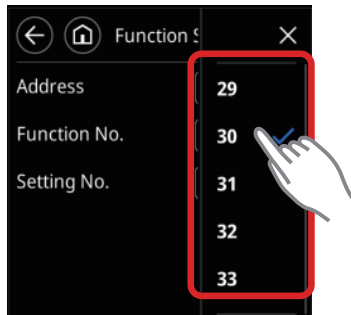

6. Tap "Setting No." on the Function Setting screen.

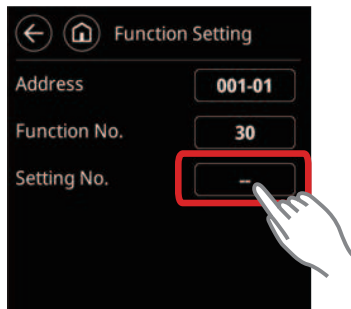

7. Pull-down window of "Setting No." is displayed. Set the Setting No.

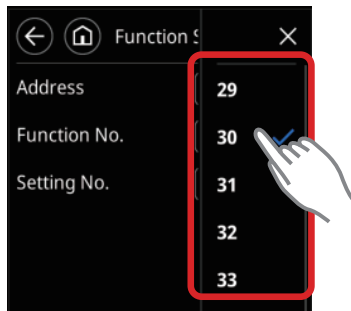

8. Tap "Set" on the verification screen.

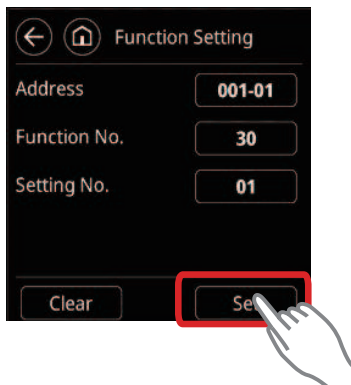

Tap  to return to the Initial Setting screen.

15-5. Indoor unit (setting by simple remote controller)

- The function settings of the control of the indoor unit can be changed by this procedure according to the installation conditions. Incorrect settings can cause the indoor unit malfunction.
- After the power is turned on, perform the “Function setting” according to the installation conditions using the remote controller.
- The settings may be selected between the following two: Function number or Setting number.
- Settings will not be changed if invalid numbers or setting numbers are selected.
- This function cannot be used on the secondary units.

■ Preparation

Before connecting the power supply of the indoor unit, reconfirm following items:

- Piping air tightness test and vacuuming have been performed firmly.
- There is no wiring mistake. Then, connect the power supply of the indoor unit.

■ UTY-RSNYM

● Button name and function

During address setting mode, indoor unit reject the any operation command from remote controller.

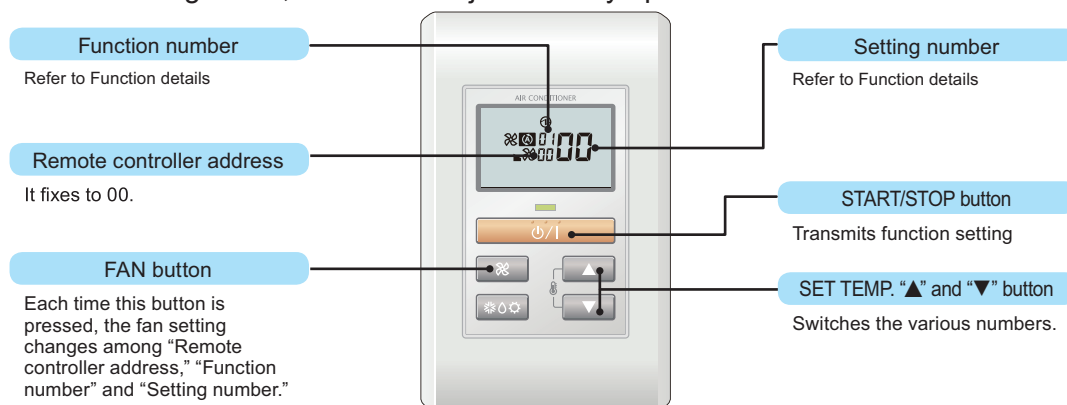

● Function setting procedure

1. Connect the power supply of the outdoor unit.
2. Switch to the function setting mode.

To enter the function setting mode, hold down the 3 buttons of SET TEMP. ▲, SET TEMP. ▼ and FAN at the same time for 5 seconds or longer.

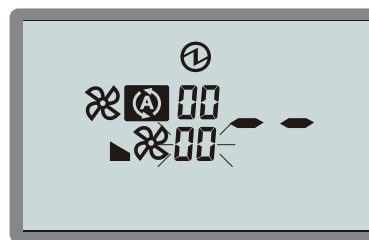
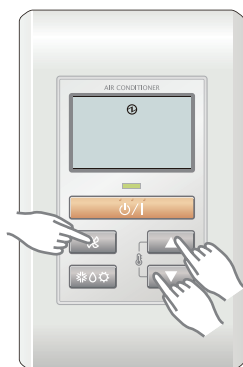

Function setting mode initial display

3. Press the FAN button.
The Function number indicator flashes. Then, press either the SET TEMP. ▲ button or the SET TEMP. ▼ button to set up the function number.

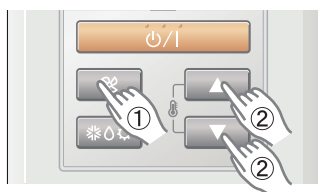

Function number

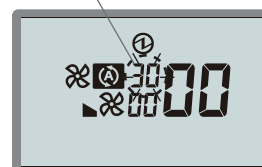

4. Select the setting number by pressing the SET TEMP. ▲ or SET TEMP. ▼ button. The setting number indicator flashes during setting number selection.

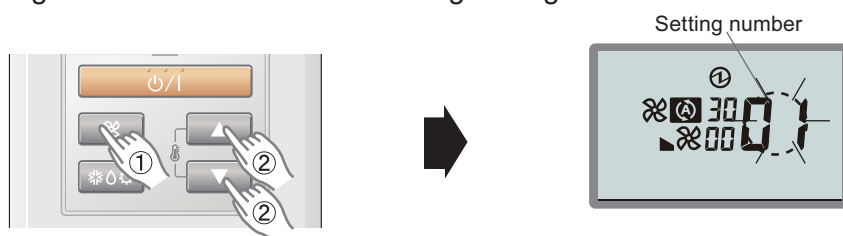

Example) Function number : 30, Setting number : 01

5. Confirm the setting by pressing the TIMER SET button. The data will be transferred to the indoor unit.

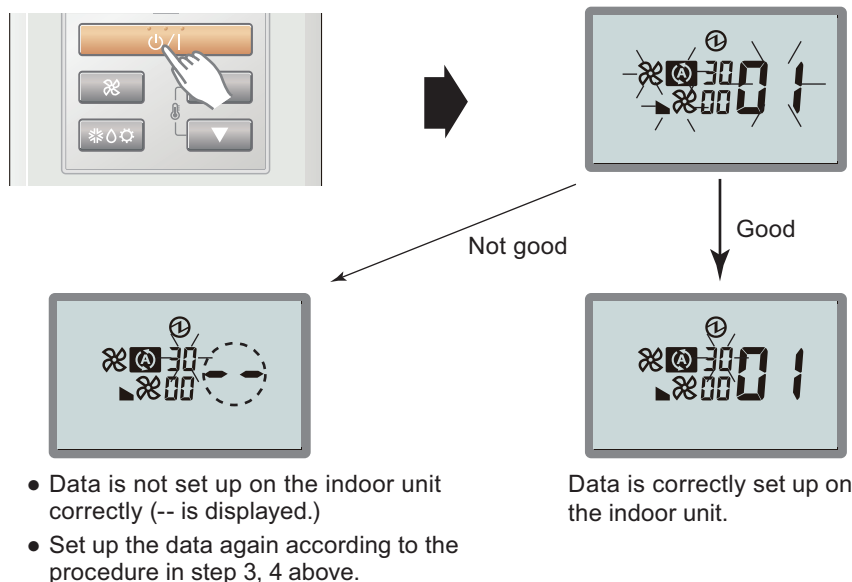

Function details: Refer to Chapter 15-6. "[Function details](#)" on page 255.

6. Exit the function setting mode by pressing the 3 buttons of SET TEMP. ▲, SET TEMP. ▼, and FAN at the same time for 5 seconds or longer. After exiting the function setting mode, the display returns to the normal mode.

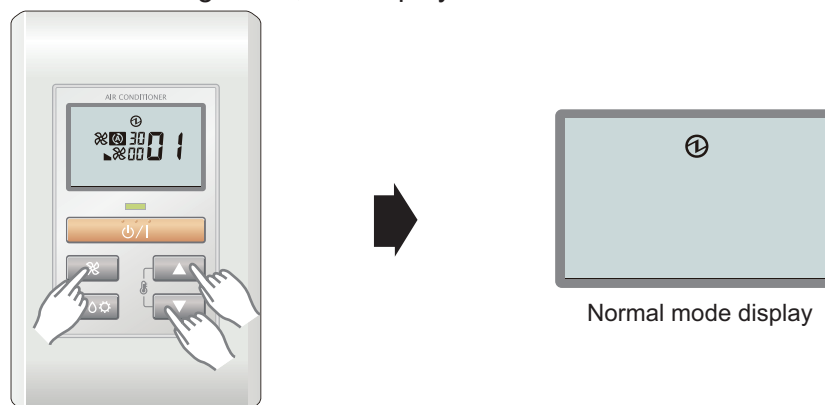

If no button is pressed within 60 seconds after buttons mentioned above are pressed, it will automatically exit the function setting mode.

If you exit the function setting mode unintentionally during setting, enter the mode again according to the procedure in step 2.

● Setting up each indoor unit

Repeat the procedures from step 1 to 6, and set up the indoor units requiring function setting.

● Resetting the power after setting up function of all indoor units

NOTES:

- If the reset is not performed, function cannot be read correctly.
- After all the functions have been set, the circuit breaker needs to be switched off for at least 2 minutes.
 - After the 2 minutes has passed, power can be restored.
 - The set function is stored in the PCB and will remain in memory even when the power of indoor unit is turned off.
However setting function is effective after disconnecting the power supply and then reconnecting it.
- Record the latest configuration of the indoor unit function setting on a label, and put the label on the unit so it can be used for after-sales service operations.

■ UTY-RSRY/UTY-RHRY

● Setting procedure by using wired remote controller

The function number and the associated setting value are displayed on the LCD of the remote controller. Follow the instructions written in the local setup procedure supplied with the remote controller, and select appropriate setting according to the installation environment.

Before connecting the power supply of the indoor unit, reconfirm following items:

- Piping air tightness test and vacuuming have been performed firmly.
- There is no wiring mistake.

NOTE: Set only one Master remote controller.

1. Connect the power supply.
2. With “Monitor mode” screen displayed, press and hold the SET TEMP. \wedge button and FAN \vee button simultaneously for at least 2 seconds.

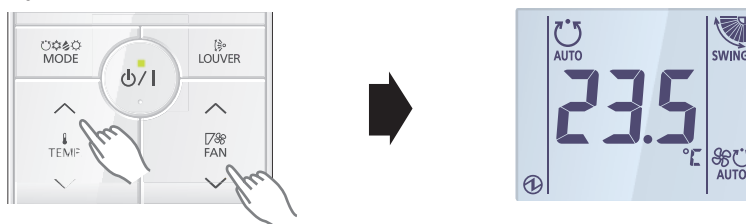

3. The Menu 1 screen is displayed. Press and hold the SET TEMP. \wedge button at least 2 seconds. Setting mode selection screen is displayed.

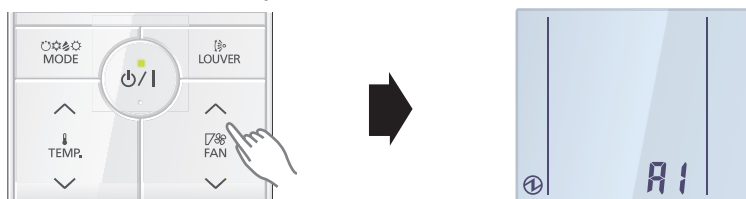

4. Press the SET TEMP. \wedge or SET TEMP. \vee button to select F1 (Menu 2-F1) setting mode or F2 (Menu 2-F2) setting mode.

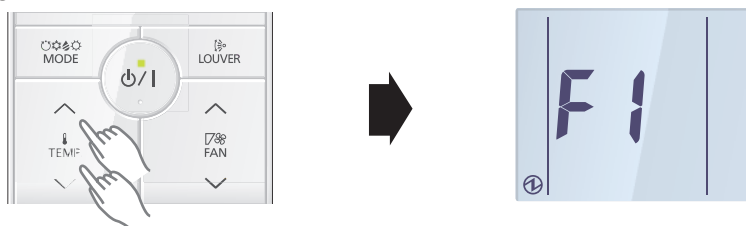

F1: Initial settings mode

F2: Maintenance settings mode

5. Press the ϕ/I button. Setting item selection screen is displayed. (Item No. is displayed.)



6. Select the item number to be set with the SET TEMP. \wedge or SET TEMP. \vee button, and press the ϕ/I button to switch to the setting screen.

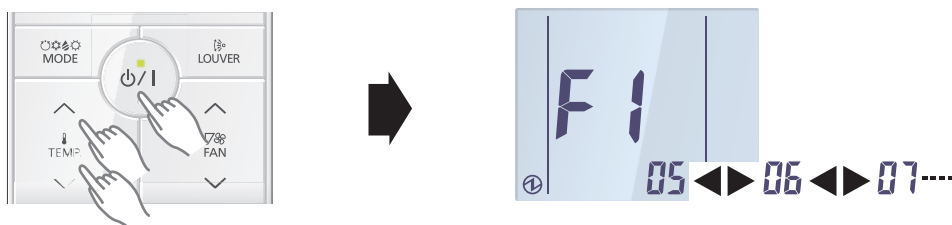

7. Select the "13" in Menu 2-F1 settings. Then, press the ϕ/I button.

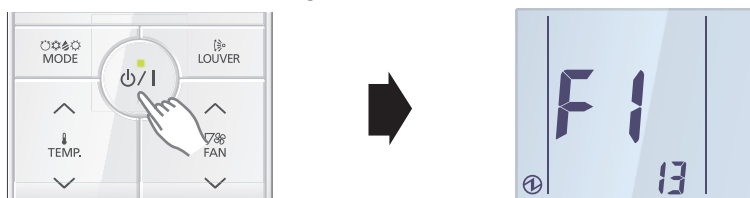

8. Select the 2-wire remote controller address with the SET TEMP. \wedge or SET TEMP. \vee button. Then press the ϕ/I button.

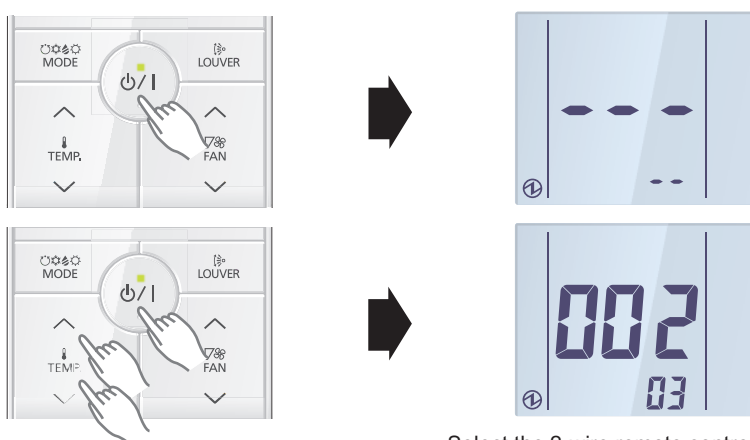

Select the 2-wire remote controller address (Ex. Select the 002-03)

9. Set the function number with the SET TEMP. \wedge or SET TEMP. \vee button. Then press the ϕ/I button.

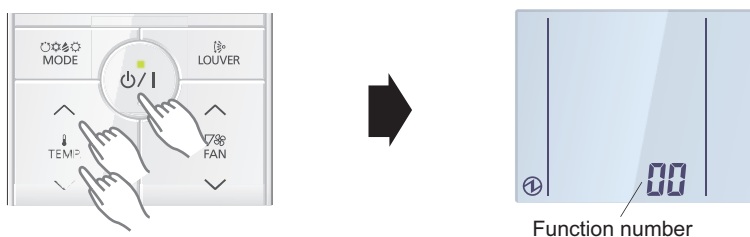

Function number

10. Set the setting number with the SET TEMP. \wedge or SET TEMP. \vee button. Then press the ϕ/I button.

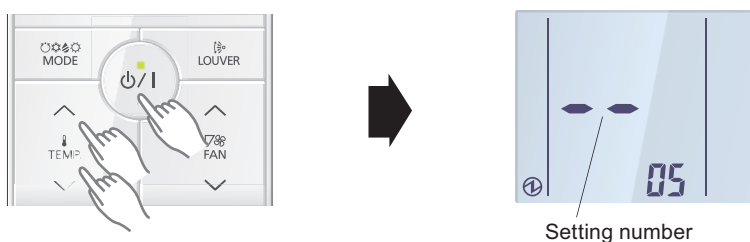

Setting number

11. Setting results are displayed after data transmission.

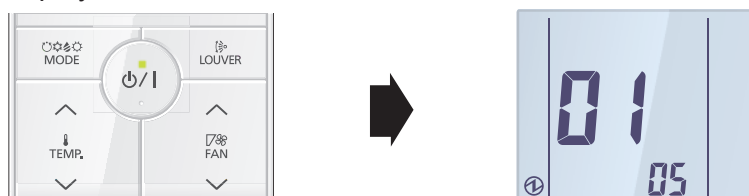

12. Press the ϕ /I button to return to the 2-wire remote controller address selection screen of step 9. If setting has been completed, press the FAN ∇ button to return to the Menu 2-F1 item selection screen.

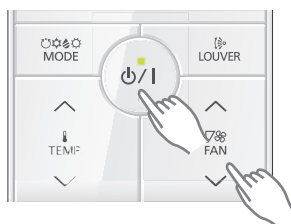

● Setting up each indoor unit

Repeat the procedure from step 1 to 6, and set up the indoor units requiring function setting.

● Resetting the power after setting up function of all indoor units

NOTES:

- If the reset is not performed, function cannot be read correctly.
- After all the functions have been set, the circuit breaker needs to be switched off for at least 2 minutes.
 - After the 2 minutes has passed, power can be restored.
 - The set function is stored in the PCB and will remain in memory even when the power of indoor unit is turned off. However setting function is effective after disconnecting the power supply and then reconnecting it.
- Record the latest configuration of the indoor unit function setting on a label, and put the label on the unit so it can be used for after-sales service operations.

15-6. Function details

■ Contents of function setting

Each function setting listed in this section is adjustable in accordance with the installation environment.

NOTE: Setting will not be changed if invalid numbers or setting values are selected.

● Function setting list

	Function no.	Functions	Compact cassette	Mini duct	Slim duct	Medium static pressure duct	Floor
1)	11	Filter sign	●	●	●	●	●
2)	20	Ceiling height	●	—	—	—	—
3)	22	Outlet directions	●	—	—	—	—
4)	26	Static pressure	—	●	●	●	—
5)	30/31	Room temperature control for indoor unit sensor	●	●	●	●	●
6)	35/36	Room temperature control for wired remote controller sensor	●	●	●	●	—
7)	40	Auto restart	●	●	●	●	●
8)	42	Room temperature sensor switching	●	●	●	●	●
9)	44	Remote controller custom code	●	●	●	●	●
10)	46	External input control	●	●	●	●	●
11)	48	Room temperature sensor switching (Aux.)	●	●	●	●	—
12)	49	Indoor unit fan control for energy saving for cooling	●	●	●	●	—
13)	60	Switching functions for external output terminal	●	●	●	●	●
14)	68	Auto mode type	—	—	—	●	—
15)	69	Deadband value	—	—	—	●	—

	Function no.	Functions	Wall mounted			
			KMCG (-B)	KETF (-B)	KGTG	KNCA
1)	11	Filter sign	●	●	●	●
2)	20	Ceiling height	—	—	—	—
3)	22	Outlet directions	—	—	—	—
4)	26	Static pressure	—	—	—	—
5)	30/31	Room temperature control for indoor unit sensor	●	●	●	●
6)	35/36	Room temperature control for wired remote controller sensor	●	●	●	—
7)	40	Auto restart	●	●	●	●
8)	42	Room temperature sensor switching	●	●	●	—
9)	44	Remote controller custom code	●	●	●	●
10)	46	External input control	●	●	●	—
11)	48	Room temperature sensor switching (Aux.)	●	●	●	—
12)	49	Indoor unit fan control for energy saving for cooling	●	●	●	●
13)	60	Switching functions for external output terminal	●	●	●	—

1) Filter sign

Select appropriate intervals for displaying the filter sign on the indoor unit according to the estimated amount of dust in the air of the room.

If the indication is not required, select "No indication" (03).

Function number	Setting value	Setting description	Factory setting
11	00	Standard	
	01	Long interval	
	02	Short interval	
	03	No indication	◆

Setting description	Compact cassette	Medium static pressure duct	Mini duct	Slim duct	Wall mounted
Standard	2,500 hours		400 hours		
Long interval	4,400 hours		1,000 hours		
Short interval	1,250 hours		200 hours		

2) Ceiling height (for Compact cassette type only)

Select the appropriate ceiling height according to the place of installation.

Function number	Setting value	Setting description	Factory setting
20	00	Standard	◆
	01	High ceiling	

For the specific height for each setting value, refer to "Installation space" in Chapter 4. "[Dimensions](#)" on page 15.

NOTE: The ceiling height values are for the 4-way outlet. Do not change this setting in the 3-way outlet mode.

7,000 or 9,000 Btu/h models cannot be installed in high ceilings. Do not change this setting.

3) Outlet directions (for Compact cassette type only)

Select the appropriate number of outlet directions according to the installation conditions.

Function number	Setting value	Setting description	Factory setting
22	00	4-way	◆
	01	3-way	

4) Static pressure (for Mini duct type, Slim duct type, and Medium static pressure duct type)

Select the appropriate static pressure according to the installation conditions.

For mini duct type:

Function number	Setting value	Setting description	Factory setting
26	00	0 Pa	
	01	10 Pa	
	02	20 Pa	
	03	30 Pa	
	04	40 Pa	
	05	50 Pa	
	31	Standard (10 Pa: 07; 09; 12 models, 15 Pa: 14 models)	

NOTES:

- Range of static pressure is different by model. 07, 09, 12 models are 0 to 30 Pa. 14 model are 0 to 50 Pa.
- Setting number in 07, 09, 12 models is “04 to 30”: Operation is same as that “03”.
- Setting number in 14 model is “06 to 30”: Operation is same as that “05”.
- Setting number value cannot be set to 32 or more.

For slim duct type:

Function number	Setting value	Setting description	Factory setting
26	00	0 Pa	
	01	10 Pa	
	02	20 Pa	
	03	30 Pa	
	04	40 Pa	
	05	50 Pa	
	06	60 Pa	
	07	70 Pa	
	08	80 Pa	
	09	90 Pa	
	31	Standard (25 Pa)	

For medium static pressure duct type:

Function number	Setting value	Setting description	Factory setting	
26	03	30 Pa		
	04	40 Pa		
	05	50 Pa		
	06	60 Pa		
	07	70 Pa		
	08	80 Pa		
	09	90 Pa		
	10	100 Pa		
	11	110 Pa		
	12	120 Pa		
	13	130 Pa		
	14	140 Pa		
	15	150 Pa		
	31	Standard (40 Pa)		◆
	32	Automatic airflow adjustment		

5) Room temperature control for indoor unit sensor

NOTE: If the remote sensor unit option is selected, perform this setting.

Depending on the installed environment, correction of the room temperature sensor may be required. Select the appropriate control setting according to the installed environment.

The temperature of the room temperature sensor is corrected as follows:

Corrected temp. = Temp. of the room temp. sensor - Correction temp. value

Example of correction:

When the temperature of the room temp. sensor is 26°C and the setting value is "03" (-1.0°C), corrected temp. will be 27°C (26°C - [-1.0°C]).

The temperature correction values show the difference from the Standard setting "00" (manufacturer's recommended value).

Function number		Setting value	Setting description	Factory setting	
30 (For cooling)	31 (For heating)	00	Standard setting	◆	
		01	No correction 0.0°C		
		02	-0.5°C	More cooling Less heating	
		03	-1.0°C		
		04	-1.5°C		
		05	-2.0°C		
		06	-2.5°C		
		07	-3.0°C		
		08	-3.5°C		
		09	-4.0°C		
		10	+0.5°C	Less cooling More heating	
		11	+1.0°C		
		12	+1.5°C		
		13	+2.0°C		
		14	+2.5°C		
		15	+3.0°C		
		16	+3.5°C		
17	+4.0°C				

6) Room temperature control for wired remote controller sensor (for other than Floor type and KN models in Wall-mounted type)

Depending on the installed environment, correction of the wire remote temperature sensor may be required. Select the appropriate control setting according to the installed environment.

To change this setting, set Function 42 to Both "01".

Ensure that the Thermo Sensor icon is displayed on the remote controller screen.

Function number		Setting value	Setting description	Factory setting	
35 (For cooling)	36 (For heating)	00	Standard setting	◆	
		01	No correction 0.0°C		
		02	-0.5°C	More cooling Less heating	
		03	-1.0°C		
		04	-1.5°C		
		05	-2.0°C		
		06	-2.5°C		
		07	-3.0°C		
		08	-3.5°C		
		09	-4.0°C		
		10	+0.5°C	Less cooling More heating	
		11	+1.0°C		
		12	+1.5°C		
		13	+2.0°C		
		14	+2.5°C		
		15	+3.0°C		
		16	+3.5°C		
17	+4.0°C				

7) Auto restart

Enables or disables automatic restart after a power interruption.

Function number	Setting value	Setting description	Factory setting
40	00	Enable	◆
	01	Disable	

NOTE: Auto restart is an emergency function such as for power outage etc. Do not attempt to use this function in normal operation. Be sure to operate the unit by remote controller or external device.

8) Room temperature sensor switching (for other than KN models in Wall-mounted type)

When using the wired remote controller temperature sensor, change the setting to "Both" (01).

Function number	Setting value	Setting description	Factory setting
42	00	Indoor unit	◆
	01	Both	

00: Sensor on the indoor unit is active.

01: Sensors on both indoor unit and wired remote controller are active.

NOTES:

- Remote controller sensor must be turned on by using the remote controller.
- When using the remote sensor unit, set to "00" or set to "01" and then select "indoor unit sensor" from wired remote controller.

9) Remote controller custom code

(Only for wireless remote controller)

The indoor unit custom code can be changed. Select the appropriate custom code.

Function number	Setting value	Setting description	Factory setting
44	00	A	◆
	01	B	
	02	C	
	03	D	

10) External input control

“Operation/Stop” mode or “Forced stop” mode can be selected.

Function number	Setting value	Setting description	Factory setting
46	00	Operation/Stop mode 1 (Remote controller enabled)	◆
	01	(Setting prohibited)	
	02	Forced stop mode	
	03	Operation/Stop mode 2 (Remote controller disabled)	

NOTE: If this function is necessary, the rotary switch on the External input and output PCB should be set to 1.

11) Room temperature sensor switching (Aux.) (for other than Floor type and KN models in Wall-mounted type)

To use the temperature sensor on the wired remote controller only, change the setting to “Wired remote controller” (01).

This function will only work if the function setting 42 is set at “Both” (01).

When the setting value is set to “Both” (00), more suitable control of the room temperature is possible by setting function setting 30 and 31 too.

Function number	Setting value	Setting description	Factory setting
48	00	Both	◆
	01	Wired remote controller	

12) Indoor unit fan control for energy saving for cooling (for other than Floor type)

Enables or disables the power-saving function by controlling the indoor unit fan rotation when the outdoor unit is stopped during cooling operation.

Function number	Setting value	Setting description	Factory setting
49	00	Disable	
	01	Enable	
	02	Remote controller	◆

00: When the outdoor unit is stopped, the indoor unit fan operates continuously following the setting on the remote controller.

01: When the outdoor unit is stopped, the indoor unit fan operates intermittently at a very low speed.

02: Enable or disable this function by remote controller setting.

NOTE: Set to “00” or “01” when connecting a remote controller that cannot set the Fan control for energy saving function or connecting a network converter. To confirm if the remote controller has this setting, refer to the operating manual of each remote controller.

13) Switching functions for external output terminal (For other than KETA[-B] and KN models in Wall-mounted type)

Functions of the external output terminal can be switched. For details, refer to “External input and output”.

Function number	Setting value	Setting description	Factory setting
60	00	Operation status	◆
	01—08	(Setting prohibited)	
	09	Error status	
	10	Indoor unit fan operation status	
	11	(Setting prohibited)	

14) Auto mode type (for Medium static pressure duct type)

Switches the setting method of the auto mode between single or dual (cooling and heating.)
Set the primary indoor unit using a wired remote controller for heat pump systems.

Function number	Setting value	Setting description	Factory setting
68	00	Single setpoint auto mode	◆
	01	Dual setpoint auto mode	

NOTE: The auto mode type setting is available only if a compatible operating device is connected.

15) Deadband value (for Medium static pressure duct type)

Sets the minimum temperature of the deadband in the dual setpoint auto mode (the setting value 01 of the function setting number 68: Auto mode type.)

Function number	Setting value	Setting description	Factory setting
69	00	0°C	◆
	01	0.5°C	
	02	1.0°C	
	03	1.5°C	
	04	2.0°C	
	05	2.5°C	
	06	3.0°C	
	07	3.5°C	
	08	4.0°C	
	09	4.5°C	

NOTE: The deadband setting is available only if a compatible operating device is connected.

15-7. Wired remote controller (UTY-RNNYM)

DIP switch 1	SW1	Prohibited
	SW2	Dual remote controller setting
	SW3	Prohibited
	SW4	°F/°C switch
	SW5	Prohibited
	SW6	Memory backup setting

* Do not use DIP switch 2.

Switch location

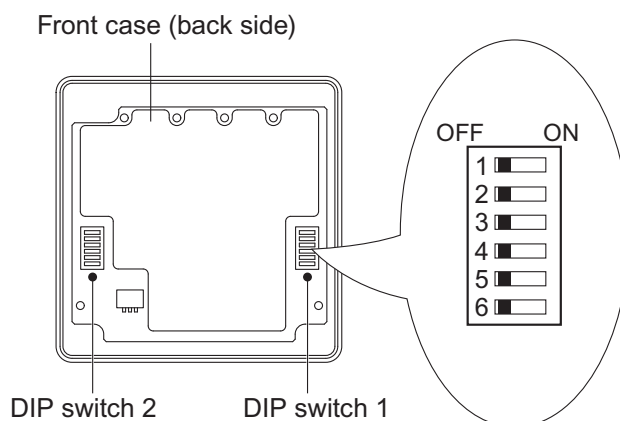

DIP switch 1 setting

● SW2: Dual remote controller setting

Set the remote controller SW2 according to the following table.

Number of remote controller	Primary unit	Secondary unit	Factory setting
	SW2	SW2	
1 (Normal)	OFF	—	◆
2 (Dual)	OFF	ON	

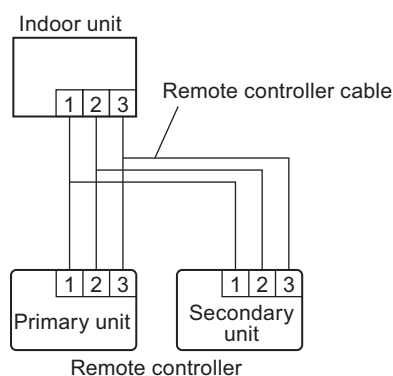

● SW4: Switching temperature unit °F / °C

Displayed temperature unit can be switched between Fahrenheit (°F) and Celsius (°C).

SW4	Fahrenheit (°F) / Celsius (°C)	Factory setting
OFF	°C	◆
ON	°F	

● SW6: Memory backup setting

Set to "ON" to use batteries for the memory backup.

When batteries are not used, all of settings stored in memory will be deleted if there is a power failure.

SW6	Memory backup	Factory setting
OFF	Disable	◆
ON	Enable	

15-8. Wired remote controller (UTY-RVNYM)

DIP switch 1	SW1	Memory backup setting
	SW2	Dual remote controller setting

■ Switch location

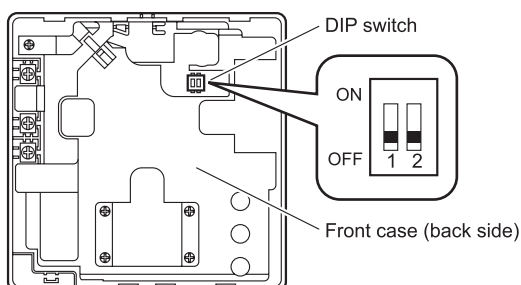

■ DIP switch setting

● SW1: Memory backup setting

Set to "ON" to use batteries for the memory backup.

When batteries are not used, all of settings stored in memory will be deleted if there is a power failure.

SW1	Memory backup	Factory setting
OFF	Disable	◆
ON	Enable	

● SW2: Dual remote controller setting

Set the remote controller SW2 according to the following table.

Number of remote controller	Primary unit	Secondary unit	Factory setting
	SW2	SW2	
1 (Normal)	OFF	—	◆
2 (Dual)	OFF	ON	

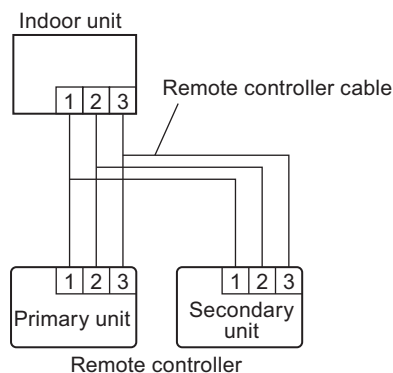

15-9. Wired remote controller (UTY-RLRY)

DIP switch	Memory backup setting
------------	-----------------------

■ Switch location

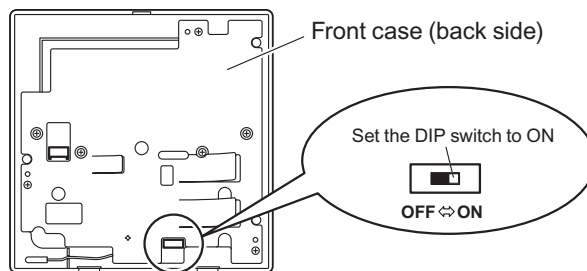

■ Dip switch setting

● SW1: Memory backup setting

Set to "ON" to use batteries for the memory backup.

When batteries are not used, all of settings stored in memory will be deleted if there is a power failure.

SW1	Memory backup	Factory setting
OFF	Disable	◆
ON	Enable	

15-10. Wired remote controller (UTY-RNRYZ*)

DIP switch	Memory backup setting
------------	-----------------------

■ Switch location

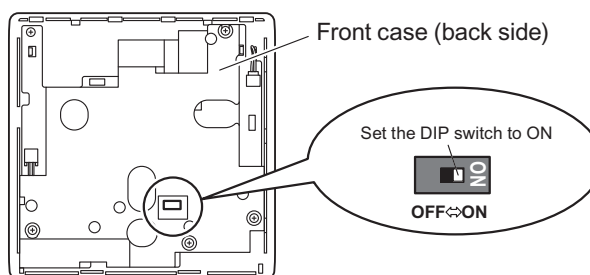

■ Dip switch setting

● SW1: Memory backup setting

Set to "ON" to use batteries for the memory backup.

When batteries are not used, all of settings stored in memory will be deleted if there is a power failure.

SW1	Memory backup	Factory setting
OFF	Disable	◆
ON	Enable	

15-11. Simple remote controller (UTY-RSNYM)

DIP switch	SW1	Prohibited
	SW2	Dual remote controller setting
	SW3	°F/°C switch
	SW4	Prohibited
	SW5	Prohibited
	SW6	Prohibited

■ Switch location

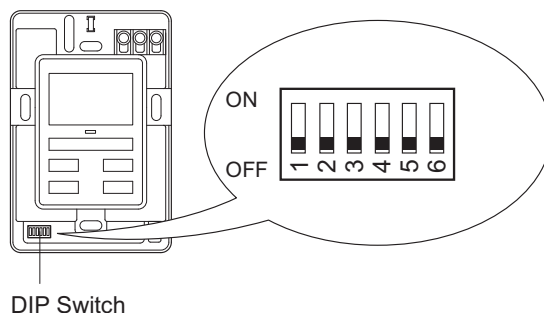

■ DIP switch setting

● SW2: Dual remote controller setting

Set the remote controller SW2 according to the following table.

Number of remote controller	Primary unit	Secondary unit	Factory setting
	SW2	SW2	
1 (Normal)	OFF	—	◆
2 (Dual)	OFF	ON	

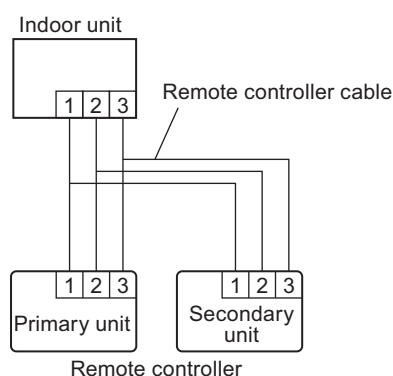

● SW3: Switching temperature unit °F / °C







Displayed temperature unit can be switched between Fahrenheit (°F) and Celsius (°C).

SW3	Fahrenheit (°F) / Celsius (°C)	Factory setting
OFF	°C	◆
ON	°F	

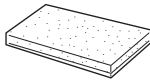
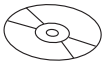
16. Accessories

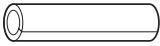
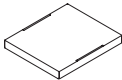
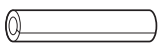



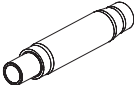





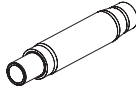

16-1. Compact cassette type

■ Models: AUXG07-14KVLA

Part name	Exterior	Qty	Part name	Exterior	Qty
Operation manual		1	Drain hose insulation		1
Operation manual (CD-ROM)		1	Hose band		1
Installation manual		1	Coupler heat insulation (large)		1
Template (Carton top)		1	Coupler heat insulation (small)		1
M10 nut A (with flange)		4	Cable tie		2
M10 nut B (with spring lock washer)		4	Wire crammer		1
Drain hose		1			

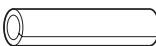

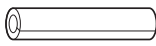





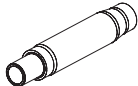

16-2. Mini duct type

■ Models: ARXG07-14KSLAP

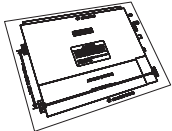
Part name	Exterior	Qty	Part name	Exterior	Qty
Operation manual		1	Drain hose		1
Operation manual (CD-ROM)		1	Hose band		1
Installation manual		1	Drain hose insulation B		1
Installation template (Carton top)		1	Washer		8
Cable tie (large)		4	Coupler heat insulation (large)		1
Cable tie (medium)		3	Coupler heat insulation (small)		1
Filter (small)		2	Insulation (For electrical wiring)		2



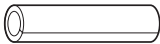

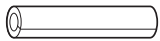



16-3. Slim duct type

■ Models: ARXG07-14KLLAP

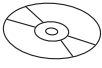
Part name	Exterior	Qty	Part name	Exterior	Qty
Operation manual		1	Filter (small)		2
Operation manual (CD-ROM)		1	Drain hose		1
Installation manual		1	Hose band		1
Installation template		1	Drain hose insulation B		1
Washer		8	Insulation (for electrical wiring)		2
Cable tie (large)		4	Coupler heat insulation (large)		1
Cable tie (medium)		3	Coupler heat insulation (small)		1



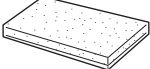
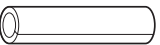
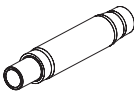
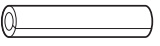







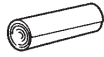

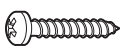
16-4. Medium static pressure duct type

■ Models: ARXH12-14KMTAP

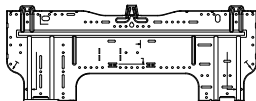



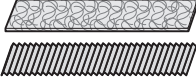

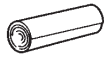

Part name	Exterior	Qty	Part name	Exterior	Qty
Operation manual		1	Cable tie (large)		4
Operation manual (CD-ROM)		1	Cable tie (medium)		1
Installation manual		1	Cable tie (small)		1
Washer		8	Drain hose insulation		1
Coupler heat insulation (large)		1	Drain hose		1
Coupler heat insulation (small)		1	Hose band		1

16-5. Wall mounted type



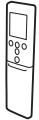
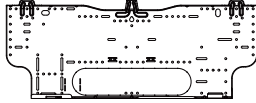



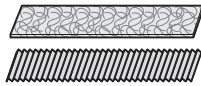
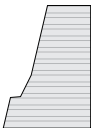

■ Models: ASEH07-14KMCG, ASEH07-14KMCG-B, and ASEH07-14KGTG

Part name	Exterior	Qty	Part name	Exterior	Qty
Operation manual		1	Cloth tape		1
Installation manual		1	Self-tapping screw (large)		5
Remote controller		1	Self-tapping screw (small)		2
Battery		2	Wall hook bracket		1
Remote controller holder		1	Filter holder		2
Installation spacer		1	Air cleaning filters		1
Operation manual (CD-ROM)		1			

Models: ASEG07-14KETF and ASEG07-14KETF-B

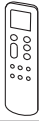
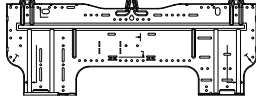

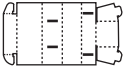
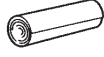



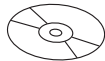

Part name	Exterior	Qty	Part name	Exterior	Qty
Operation manual		1	Cloth tape		1
Operation manual (CD-ROM)		1	Self-tapping screw (large)		5
Installation manual		1	Self-tapping screw (small)		2
Remote controller		1	Wall hook bracket		1
Battery		2	Filter holder		2
Remote controller holder		1	Air cleaning filters		1
Template (for pipe cover cutting)		1			

Models: ASEH05-12KNCA

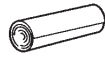
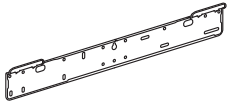
Part name	Exterior	Qty	Part name	Exterior	Qty
Operation manual		1	Self-tapping screw (Large)		5
Installation manual		1	Self-tapping screw (Small)		2
Remote controller		1	Wall hook bracket		1
Battery		2	Remote controller holder		1
Installation spacer		1	Cloth tape		1
Operation manual (CD-ROM)		1			

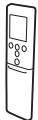
16-6. Floor type

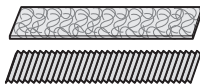
■ Models: AGEG09-14KVCA

Part name	Exterior	Qty	Part name	Exterior	Qty
Operation manual		1	Operation manual (CD-ROM)		1
Installation manual		1	Cloth tape		1
Wall hook bracket		1	Self-tapping screws (large)		9
Remote controller		1	Self-tapping screws (small)		2
Battery		2	Air cleaning filters		1
Remote controller holder		1			

17. Optional parts

17-1. Controllers

■ Lineup

Indoor unit type		Type		
		Wireless Remote Controller		
		AR-REM7E	AR-REW3E	AR-REW4E
Compact cassette		—	—	—
Mini duct		—	—	—
Slim duct		—	—	—
Medium static pressure duct		—	—	—
Floor		●	—	—
Wall mounted	KMCG(-B)	—	—	—
	KETF(-B)	—	—	●
	KGTG	—	●	—
	KNCA	—	—	—

Indoor unit type		Type		
		Wireless Remote Controller		
		AR-RMB1E(-B)	AR-RPF4E	UTY-LNTY
Compact cassette		—	—	○
Mini duct		—	—	—
Slim duct		—	—	—
Medium static pressure duct		—	—	—
Floor		—	—	—
Wall mounted	KMCG(-B)	●	—	—
	KETF(-B)	—	—	—
	KGTG	—	—	—
	KNCA	—	●	—

Indoor unit type		Type			
		Wired Remote Controller			
		UTY-RNNYM	UTY-RVNYM	UTY-RVRY	UTY-RLRY
Compact cassette		○	○	○	○
Mini duct		○	○	○	○
Slim duct		○	○	○	○
Medium static pressure duct		—	—	○	○
Floor		—	—	○*2	○*2
Wall mounted	KMCG(-B)	—	—	○*1	○*1
	KETF(-B)	—	—	○*1	○*1
	KGTG	—	—	○*1	○*1
	KNCA	—	—	—	—





Indoor unit type		Type		
		Wired Remote Controller		IR Receiver Kit with Wireless Remote Controller
		UTY-RNRYZ*	UTY-RCRYZ1	UTY-LBTYM
Compact cassette		○	○	—
Mini duct		○	○	○
Slim duct		○	○	○
Medium static pressure duct		○	○	○
Floor		○*1	○*1	—
Wall mounted	KMCG(-B)	○*1	○*1	—
	KETF(-B)	○*1	○*1	—
	KGTG	○*1	○*1	—
	KNCA	—	—	—



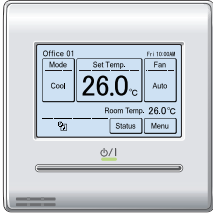
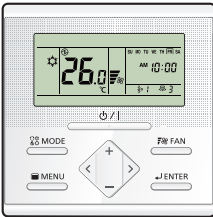

Indoor unit type		Type		
		Simple Remote Controller		
		UTY-RSNYM	UTY-RSRY	UTY-RHRY
Compact cassette		○	○	○
Mini duct		○	○	○
Slim duct		○	○	○
Medium static pressure duct		—	○	○
Floor		—	○*2	○*2
Wall mounted	KMCG(-B)	—	○*1	○*1
	KETF(-B)	—	○*1	○*1
	KGTG	—	○*1	○*1
	KNCA	—	—	—

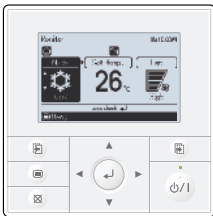
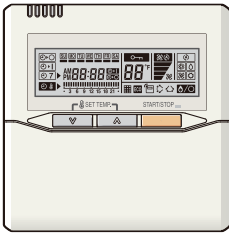
●: Accessory, ○: Optional, —: Not applicable

- *1: Optional Communication Kit (UTY-TWRXZ2) is necessary for the installation.
- *2: Optional Communication Kit (UTY-TWRXZ3) is necessary for the installation.

Parts

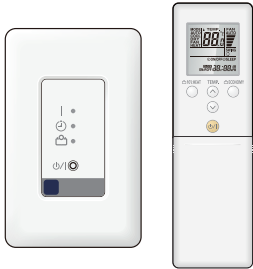
Exterior	Part name	Model name	Summary
	Wired Remote Controller (Touch Panel)	UTY-RVRY	Remote controller that provides the functions you need in a sleek design that uniquely transforms itself to blend with any interior. Wire type: Non-polar 2-wire
	Wired Remote Controller	UTY-RNRYZ*	Easy finger touch operation with LCD panel. Backlit LCD enables easy operation in a dark room. Wire type: Non-polar 2-wire
	Wired Remote Controller	UTY-RLRY	High visibility and easy operation. Room temperature can be accurately controlled using the thermo sensor. Wire type: Non-polar 2-wire
	Compact Wired Remote Controller	UTY-RCRYZ1	Compact body and easy operation. Room temperature can be accurately controlled using the thermo sensor. Wire type: Non-polar 2-wire
	Wired Remote Controller	UTY-RVNYM	Large and full-dot liquid crystal screen, wide and large keys easy to press, user-intuitive arrow key. Wire type: Polar 3-wire
	Wired Remote Controller	UTY-RNNYM	Room temperature can be controlled by detecting the temperature accurately with thermo sensor. Wire type: Polar 3-wire
	Simple Remote Controller	UTY-RSRY	Compact remote controller concentrates on the basic functions such as Start/Stop, fan control, temperature setting, and operation mode. Wire type: Non-polar 2-wire

Exterior	Part name	Model name	Summary
	Simple Remote Controller	UTY-RHRY	Compact remote controller concentrates on the basic functions such as Start/Stop, fan control, and temperature setting. Wire type: Non-polar 2-wire
	Simple Remote Controller	UTY-RSNYM	Compact remote controller concentrates on the basic functions such as Start/Stop, fan control, temperature setting, and operation mode. Wire type: Polar 3-wire
	IR Receiver Kit with Wireless Remote Controller	UTY-LBTYM	Unit control is performed by Wireless Remote Controller
	Wireless Remote Controller	UTY-LNTY	Unit control is performed by Wireless Remote Controller.

NOTES:

- Available functions may differ by the remote controller. For details, refer to the operation manual.
- When using the group controlling system of the Wired Remote Controller, using WLAN Adapter is prohibited.

17-2. Cassette grille

■ Lineup

Indoor unit type	Model
Compact cassette	UTG-UFYF-W

■ Part

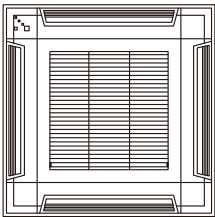
Exterior	Part name	Model name	Summary
	Cassette Grille	UTG-UFYF-W	This cassette grille can be installed appropriately on the grid type ceiling common in the office.

17-3. Others

■ Lineup

Indoor unit type		Type			
		Air Outlet Shutter Plate	Insulation Kit for High Humidity	Fresh Air Intake Kit	Half Concealed Kit
		UTR-YDZB	UTZ-KXGC	UTZ-VXAA	UTR-STA
Compact cassette		○	○	○	—
Mini duct		—	—	—	—
Slim duct		—	—	—	—
Medium static pressure duct		—	—	—	—
Floor		—	—	—	○
Wall mounted	KMCG(-B)	—	—	—	—
	KETF(-B)	—	—	—	—
	KGTG	—	—	—	—
	KNCA	—	—	—	—

Indoor unit type		Type			
		Auto Louver Grille Kit	Remote Sensor Unit		External Switch Controller
		UTD-GXTA-W	UTY-XSZX	UTY-XSZXZ*	UTY-TERX
Compact cassette		—	—	—	○
Mini duct		○	○	○	○
Slim duct		○	○	○	○
Medium static pressure duct		—	○	○	○
Floor		—	—	—	○*2
Wall mounted	KMCG(-B)	—	—	—	○*1
	KETF(-B)	—	—	—	○*1
	KGTG	—	—	—	○*1
	KNCA	—	—	—	—

Indoor unit type		Type				
		External Connect Kit			External Input and Output PCB	
		UTY-XWZX	UTY-XWZXZ5	UTY-XWZXZG	UTY-XCSXZ2	UTY-XCSX
Compact cassette		—	—	○	—	○
Mini duct		—	—	○	—	—
Slim duct		—	—	○	—	—
Medium static pressure duct		—	—	○	—	○
Floor		—	○	—	—	—
Wall mounted	KMCG(-B)	○	○	—	○	—
	KETF(-B)	○	○	—	○	—
	KGTG	○	○	—	○	—
	KNCA	—	—	—	—	—

Indoor unit type		Type			
		KNX Converter	Network Converter		Modbus Converter
			UTY-VKSX	UTY-VTGX	
Compact cassette		○	○	○	○
Mini duct		○	○	○	○
Slim duct		○	○	○	○
Medium static pressure duct		○	○	○	○
Floor		○	○*2	○*2	○
Wall mounted	KMCG(-B)	○	○*1	○*1	○
	KETF(-B)	○	○*1	○*1	○
	KGTG	○	○*1	○*1	○
	KNCA	—	—	—	—

Indoor unit type		Type	
		WLAN Adapter*3	
		UTY-TFSXZ1	UTY-TFSXJ3
Compact cassette		○	—
Mini duct		○	—
Slim duct		○	—
Medium static pressure duct		○	○
Floor		○	—
Wall mounted	KMCG(-B)	—	—
	KETF(-B)	—	—
	KGTG	—	—
	KNCA	—	—

Indoor unit type		Type			
		Communication Kit		Air Cleaning Filter	
		UTY-TWRXZ2	UTY-TWRXZ3	UTR-FA16-5	UTD-HFNC
Compact cassette		—	—	—	—
Mini duct		—	—	—	—
Slim duct		—	—	—	—
Medium static pressure duct		—	—	—	○
Floor		—	○	—	—
Wall mounted	KMCG(-B)	○	—	○	—
	KETF(-B)	○	—	—	—
	KGTG	○	—	—	—
	KNCA	—	—	○	—





Indoor unit type		Type	
		Long-life Filter	External Input and Output PCB Box
		UTD-LFDC	UTZ-GXDA
Compact cassette		—	—
Mini duct		—	—
Slim duct		—	—
Medium static pressure duct		○	○
Floor		—	—
Wall mounted	KMCG(-B)	—	—
	KETF(-B)	—	—
	KGTG	—	—
	KNCA	—	—



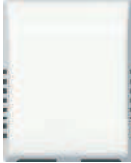

●:Accessory, ○: Optional, —: Not applicable

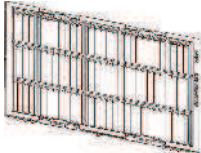
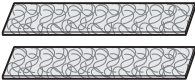
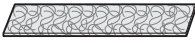
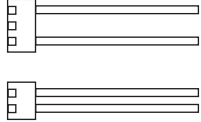
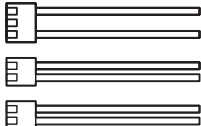
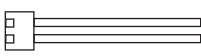

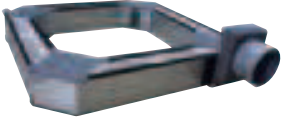
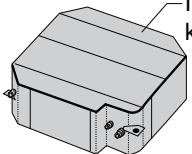

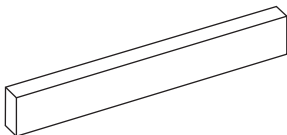
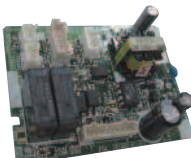
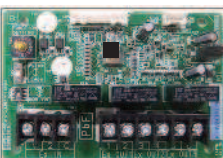
- *1: Optional Communication Kit (UTY-TWRXZ2) is necessary for the installation.
- *2: Optional Communication Kit (UTY-TWRXZ3) is necessary for the installation.
- *3: For details of wireless LAN control, refer to “Design & Technical manual” or “Setting manual” of WLAN control system.

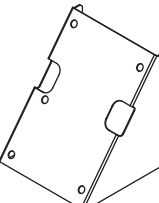
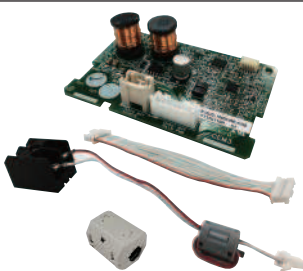
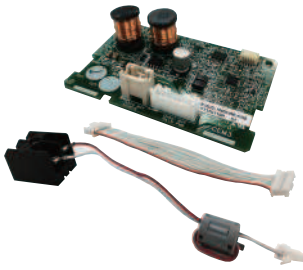
NOTE: Combined use of Modbus Converter, KNX Converter, and WLAN Adapter is not allowed.

Parts

Exterior	Part name	Model name	Summary
	Remote Sensor Unit	UTY-XSZX	Thermo-sensor for sensing the temperature of arbitrary place in the room.
	Remote Sensor Unit	UTY-XSZXZ*	Thermo-sensor for sensing the temperature of arbitrary place in the room.
	Auto Louver Grille Kit	UTD-GXTA-W	Width: 683 mm For 07, 09, 12, and 14 models
	Long-life Filter	UTD-LFDC	Long-life Filter can be mounted to the indoor unit.
	Air Cleaning Filter	UTR-FA16-5	Air Cleaning Filter can be mounted to the indoor unit. (For antibacterial)
	Air Cleaning Filter	UTD-HFNC	Air Cleaning Filter can be mounted to the indoor unit.
	External Connect Kit	UTY-XWZX	Use to connect with various peripheral devices and air conditioner PCB.
	External Connect Kit	UTY-XWZXZ5	Required when external device is connected.
	External Connect Kit	UTY-XWZXZG	Use to connect with various peripheral devices and air conditioner PCB. For control output port.
	Air Outlet Shutter Plate	UTR-YDZB	Installed at the air outlet when 3-directions mode is performed.
	Fresh Air Intake Kit	UTZ-VXAA	By attaching Fresh Air Intake Kit to the indoor unit, it can be taken in fresh air of up to 10% of "high" air volume of the indoor unit.
	Insulation Kit for High Humidity	UTZ-KXGC	Install when the under-roof condition is expected to be the humidity of over 80% and the temperature of over 30 °C.

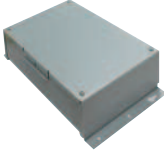
Exterior	Part name	Model name	Summary
	Half Concealed Kit	UTR-STA	Used for the indoor unit installing of half concealed.
	Communication Kit	UTY-TWBXF2	Use to connect with optional devices and air conditioner PCB.
	External Input and Output PCB	UTY-XCSX	Use to connect with external devices and air conditioner PCB. Optional External Connect Kit is necessary for installation.
	External Input and Output PCB	UTY-XCSXZ2	Use to connect with external devices and air conditioner PCB. Optional External Connect Kit is necessary for installation.
	External Input and Output PCB Box	UTZ-GXDA	For installing the External input and output PCB.
	Communication Kit	UTY-TWRXZ3	Use to connect Non-polar 2-core wired remote controller.
	Communication Kit	UTY-TWRXZ2	Use to connect Non-polar 2-core wired remote controller.
	WLAN Adapter	UTY-TFSXZ1 UTY-TFSXJ3	Remotely manage an air conditioning system using mobile devices such as smartphones and tablets. For connection indoor unit with UART interface. Appropriate application for each region is required to use this option. For details, contact FGL sales company.
	Modbus Converter	UTY-VMSX	For connection between indoor unit with UART interface and a Modbus open network.

Exterior	Part name	Model name	Summary
	KNX Converter	UTY-VKSX	For connection between indoor unit with UART interface and a KNX open network.
	Network Converter	UTY-VTGX	This converter is required when connecting single split system to VRF network system.
	Network Converter (AC power supply)	UTY-VTGXV	This converter is required when connecting single split system to VRF network system.
	External Switch Controller	UTY-TERX	Air conditioner switching can be controlled by connecting other external sensor switches.

18. Indoor unit installation precautions

NOTE: The information listed below are general precautions.
Some models also include items that do not apply.

18-1. Places where prohibited for use

- Places where there is a danger of combustible gas leakage.
- Places where sulfur gas, chlorine gas, acid, alkali, or other matter which effects equipment is generated.
- Places where there is a lot of oil splash and steam such as kitchen or machinery room.
- Places where machinery which generates high frequencies is used.
- Ocean beaches and other areas where there is a lot of salt.
- Places where carbon fibers or any kind of powder suspended in the air.
- Inside of vehicles, ships, and other conveyances.
- Places where voltage fluctuations are large such as a factory.

18-2. Points to remember when installing

- The product shall be installed at a place which can withstand the weight and vibration of the indoor.
- To allow maintenance after refrigerant piping, drain piping, and the connection/installation of electric wiring, provide an maintenance space and an inspection port, as required.
Maintenance space is shown on "[Dimensions](#)" on page 15.
- Be careful when installing the unit at the following places.

Condition	Contents	Countermeasures (Reference)
When the ceiling is high.	If the indoor unit is installed where the installation height given in the installation manual is exceeded, the temperature difference between the floor and ceiling of the room will be large and the heating effect will be poor. Moreover, even if the indoor unit is installed within the installation height, a similar phenomena will occur when installed in a room in which the doors are opened and closed frequently and hot air circulation is obstructed by furniture such as desks or chairs.	<ol style="list-style-type: none"> 1. Switch the setting to the high ceiling mode. 2. Install a circulator. 3. Arrange the furniture in the room so that it does not obstruct the hot air.
When lower level directly contacts the outside air.	When the lower level of the room is a semi-open space such as warehouse or parking lot the surface temperature of the flooring will become low and the radiation of cold from the floor will increase. In this case, even if the room temperature is suitable, you may feel the foot level is cold.	
When the airflow distribution is poor.	When an indoor unit is installed in a position where the outlet airflow will directly contact people, a draft may be felt. In addition, when there are obstructions in the path of the intake and outlet airflow, the air distribution may become extremely bad.	<ol style="list-style-type: none"> 1. Adjust the louver fins or take other measures matched to the site. 2. Change the indoor unit outlet.

Condition	Contents	Countermeasures (Reference)
When inside the ceiling is high temperature and high humidity.	When the indoor unit is installed where the inside of the ceiling is 30 °C RH80% or greater, the dew point temperature of the outer perimeter may become higher than the cabinet surface temperature and moisture will condense on the surface of the cabinet and water drops may fall inside the room. ("Figure 18-1 Moist air curve") In addition, the humidity may vary considerably the same as when the inside of the ceiling is close to hermetically sealed and used as the outside air intake path.	<ol style="list-style-type: none"> 1. Add heat insulating material to the outside of the indoor unit cabinet. *Regarding the cassette type, use of optional High humidity correspondence kit is recommended. 2. Strengthen the heat insulating material of the refrigerant pipe and drain pipe too. ("Figure 18-2 Work method when reinforcing the heat insulation of on-site piping") 3. When the humidity inside the ceiling changes considerably, install a ventilation port.
When using an external duct.	When using an external duct to take in new fresh air, etc., condensation may form on the surface of the duct due to the effect of the outside air temperature and the humidity inside the ceiling.	Always perform heat insulation processing. (Heat insulating material: Glass wool 25 mm thick or more.)
When the remote controller installation site is bad.	If the cold or warm air blown out from the air conditioner directly contacts the thermostat section of the remote controller, the outlet temperature of the air conditioner may be sensed and room temperature control will be different from the room temperature, and "not cooled" or "not heated" or other trouble may occur. In addition, there is the possibility that the same kind of trouble may also occur when the remote controller is effected by direct sunlight.	<ol style="list-style-type: none"> 1. Install the remote controller where it will not be directly exposed to the cold or hot air. 2. Install the remote controller where it will not be directly exposed to sunlight or strong lighting.
When installation environment is quiet.	When the wall mounted type was installed in a bedroom, living room, or other quiet place, the sound of the refrigerant flow may be sensed as noise and must be taken into account.	<ol style="list-style-type: none"> 1. Plan installation of a model with external expansion valve. 2. Plan installation of a branch box farther from indoor unit. 3. Plan installation using another air conditioner.
When installing duct type in ceiling chamber system.	In the case of the ceiling chamber system (duct is not installed at indoor unit inlet side and room air is sucked into the indoor unit through the inside of the ceiling), the thermistor inside the indoor unit may not correctly detect the room temperature. <ul style="list-style-type: none"> • Heating operation: Room is not heated because the indoor unit is easily turned off by the thermostat. • Cooling operation: Room is too cold because the indoor unit is difficult to turn off by the thermostat. 	Replace the indoor unit thermistor with optional remote sensor unit, and install the sensor where the room temperature can be correctly detected.
When the outlet air is sucked in at duct type.	Cooling operation does not cool the room and heating operation does not heat the room because the short circuited indoor unit is not turned on by the thermostat.	<ol style="list-style-type: none"> 1. Reconsider the ventilation port construction. 2. Replace the indoor unit thermistor with optional Remote sensor unit, and install the sensor where the room temperature can be correctly detected.
When using the wireless remote controller.	Signals may not be received when using it in a room illuminated by an inverter fluorescent lamp.	Turn on the fluorescent lamp and check if the indoor unit receives the signals from the remote controller. If the indoor unit does not receive the signals, consult an authorized service personnel.
When installing the inverter type.	It may generate noise in TV sets, stereos and PCs.	The inverter type should be installed at a sufficient distance from these equipments.

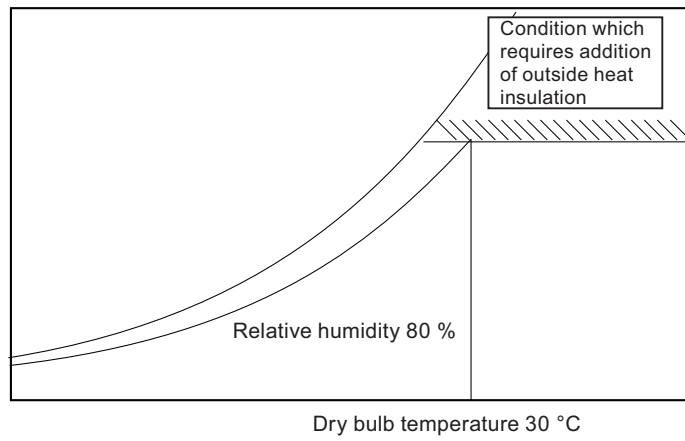

Figure 18-1 **Moist air curve**

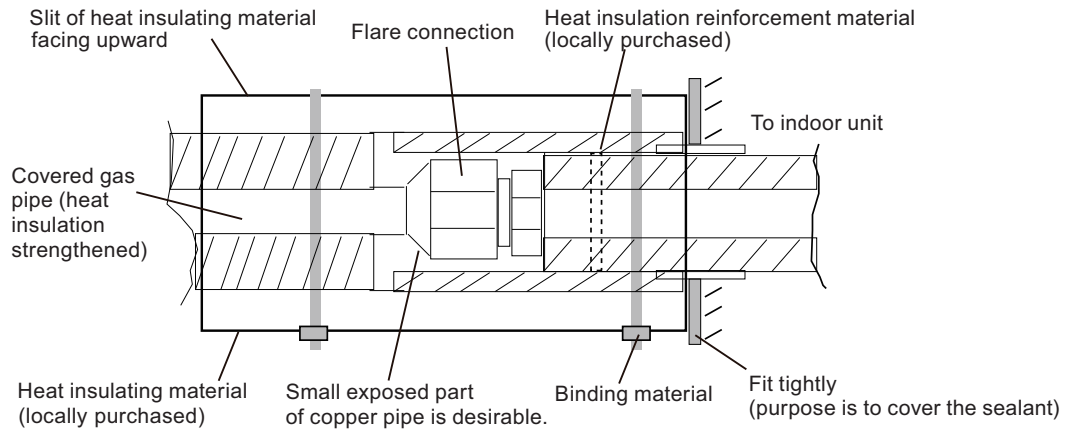

Figure 18-2 **Work method when reinforcing the heat insulation of on-site piping**

Part 2. OUTDOOR UNIT (2 UNITS TYPE)

MULTI-SPLIT TYPE:

AOEG14KBCA2

AOEG18KBCA2

1. Specifications

Type				Inverter heat pump	
Model name				AOEG14KBCA2	AOEG18KBCA2
Power source				230 V 50 Hz	
Available voltage range				198—264V	
Standard combination of indoor unit				Wall mounted ×2	Wall mounted ×2
Capacity	Cooling	Rated	kW	4.0	5.0
			Btu/h	13,600	17,100
		Min.—Max.	kW	1.4—4.6	1.7—5.8
			Btu/h	4,700—15,700	5,800—19,800
	Heating	Rated	kW	4.4	5.6
			Btu/h	15,000	19,100
		Min.—Max.	kW	1.1—5.5	1.8—6.6
			Btu/h	3,700—18,800	6,100—22,500
Input power	Cooling	kW	Rated	0.97	1.24
			Max.	1.20	1.55
	Heating		Rated	0.95	1.22
			Max.	1.65	1.80
Current	Cooling	A	Rated	4.7	5.6
	Heating		Rated	4.7	5.6
EER	Cooling	kW/kW		4.12	4.03
COP	Heating			4.63	4.59
Starting current			A	4.7	5.6
Maximum operating current *1			A	10.9	11.6
Fan	Type × Q'ty		Propeller × 1		
	Airflow rate	Cooling	m ³ /h	1,670	1,960
		Heating		1,670	2,020
	Motor output		W	23	49
Sound pressure level *2	Cooling	dB (A)	47	47	
	Heating		49	50	
Heat exchanger	Dimension (H x W x D)		mm	Main 1: 504 × 881 × 18.19	Main 1: 588 × 881 × 18.19
					Main 2: 504 × 851 × 18.19
	Fin pitch			Main 1: 1.3 Main 2: 1.3	
	Rows × Stages			Main 1: 1 × 24 Main 2: 1 × 24	
	Pipe type (Material)			Copper tube	
Fin type (Material)			Aluminum		
Compressor	Type × Quantity		DC rotary × 1		
	Motor output		W	900	DC twin rotary × 2
Refrigerant	Type (Global warming potential)		R32 (675)		
	Charge		g	900	1,020
Refrigerant oil	Type		RB68A		
	Amount		cm ³	340	350
Enclosure	Material		Steel sheet		
	Color		Beige (Approximate color of Munsell 10YR 7.5/1.0 NN)		
Dimensions (H x W x D)	Net	mm	542 × 799 × 290	632 × 799 × 290	
	Gross		602 × 940 × 375	692 × 940 × 375	
Weight	Net	kg	33	37	
	Gross		37	42	
Connection pipe	Size	Liquid	mm (in)	Ø6.35 (Ø1/4) × 2	
		Gas		Ø9.52 (Ø3/8) × 2	
	Method		Flare		
	Pre-charge length (Total)		20		
	Maximum length (Total)		30		
	Maximum length (Each)		20		
	Minimum length (Total)		5		
	Minimum length (Each)		2.5		
	Maximum height difference between outdoor unit and each indoor units.		15		
	Maximum height difference between indoor units.		10		
Operation range	Cooling	°C	-10 to 46		
	Heating		-15 to 24		
NOTES:					
<ul style="list-style-type: none"> • Specifications are based on the following conditions: <ul style="list-style-type: none"> – Power source of specifications: 230 V – Pipe length: 5 m, Height difference: 0 m [Outdoor unit—Indoor unit] – Cooling: Indoor temperature of 27.0 °CDB/19.0 °CWB, and outdoor temperature of 35 °CDB/24.0 °CWB. – Heating: Indoor temperature of 20.0 °CDB/15.0 °CWB, and outdoor temperature of 7.0 °CDB/6.0 °CWB. • *1: Maximum operating current is the total current of the indoor unit and the outdoor unit. • *2: Sound pressure level <ul style="list-style-type: none"> – Measured values in manufacturer's anechoic chamber. – Because of the surrounding sound environment, the sound levels measured in actual installation conditions might be higher than the specified values here. • For other combination, refer to the combination table. • The protective function might work when using it outside the operation range. 					

Specifications for ErP Lot10				
Model name			AOEG14KBCA2	AOEG18KBCA2
Energy efficiency class	Cooling		A+++	
	Heating (Average)		A++	
Pdesign	Cooling	kW	4.0 (35 °C)	5.0 (35 °C)
	Heating (Average)		3.5 (-10 °C)	4.2 (-10 °C)
SEER	Cooling	kWh/kWh	8.70	8.60
SCOP	Heating (Average)		4.70	
Annual energy consumption	QCE		209	263
	QHE (Average)		1,296	1,434
Sound power level	Cooling	HIGH	dB (A)	60
	Heating			62

OUTDOOR UNIT

OUTDOOR UNIT

2. Dimensions

2-1. Model: AOEG14KBCA2

Unit: mm

OUTDOOR UNIT

OUTDOOR UNIT

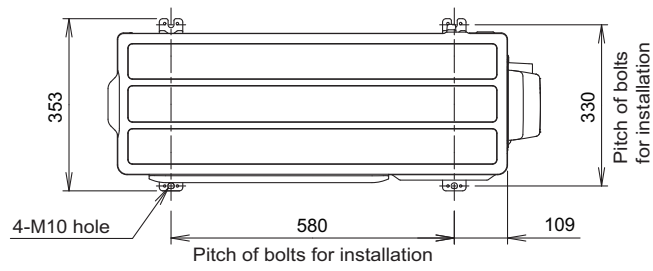

Top view

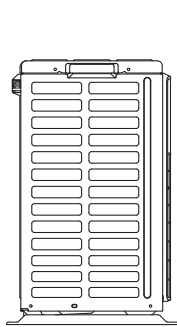

Side view

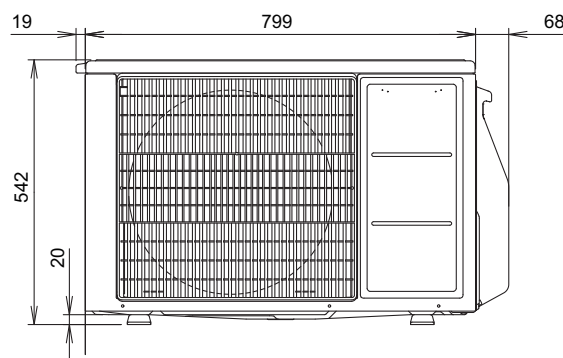

Front view

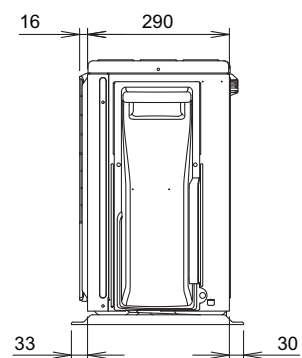

Side view

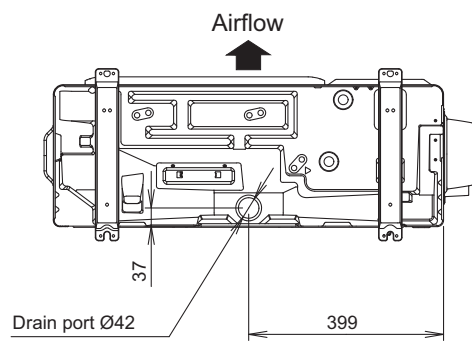

Bottom view

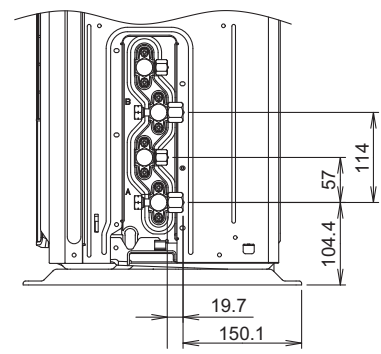

Side view (Valve part)

2-2. Model: AOEG18KBCA2

Unit: mm

OUTDOOR UNIT

OUTDOOR UNIT

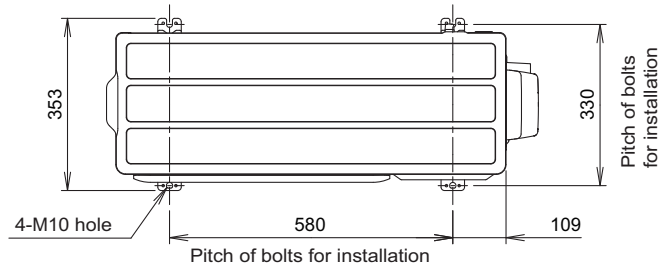

Top view

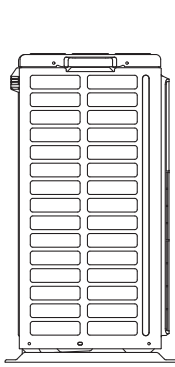

Side view

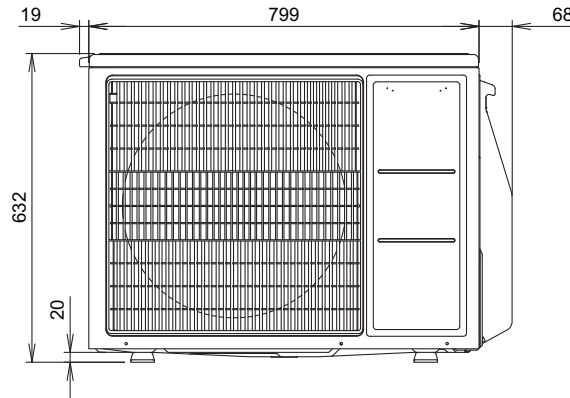

Front view

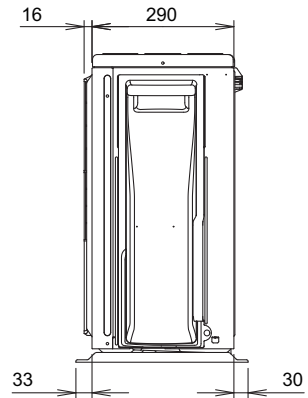

Side view

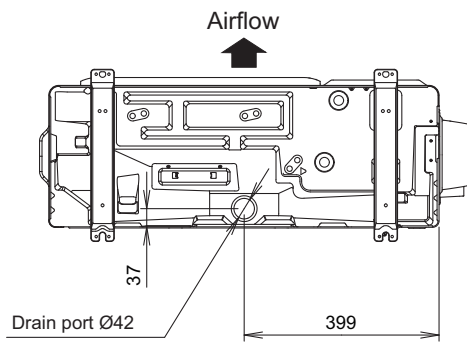

Bottom view

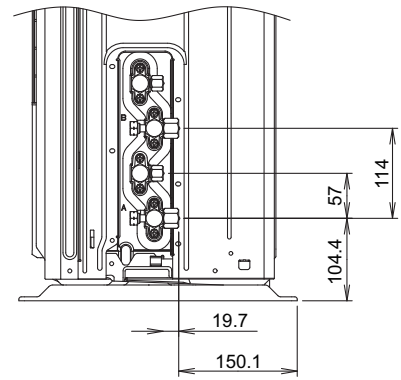

Side view (Valve part)

3. Installation space

3-1. Models: AOEG14KBCA2 and AOEG18KBCA2

■ Space requirement

Provide sufficient installation space for product safety.

⚠ CAUTION

Keep the space shown in the installation examples.

If the installation is not performed accordingly, it could cause a short circuit and result in a lack of operating performance.

● Single outdoor unit installation

- When the upper space is open:

Unit: mm

Obstacles at rear only

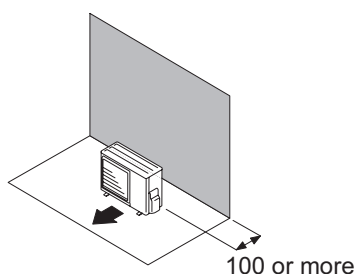

Obstacles at rear and sides

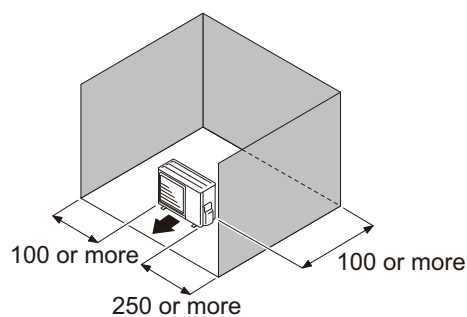

Obstacles at front

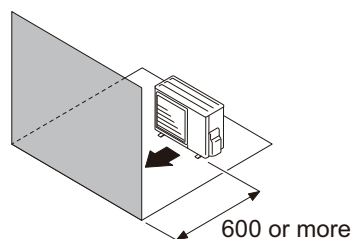

Obstacles at front and rear

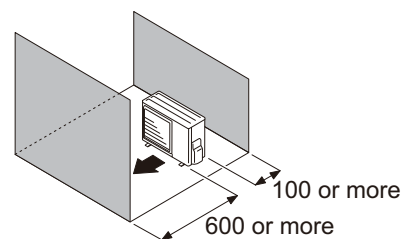

- When an obstruction in the upper space:

Unit: mm

Obstacles at rear and above

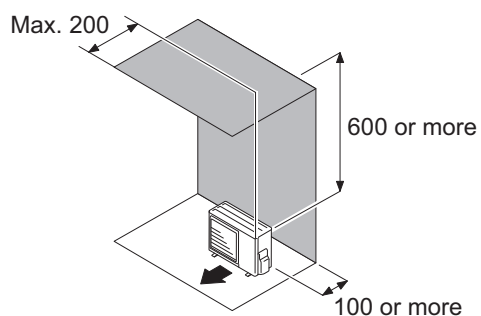

Obstacles at rear, sides, and above

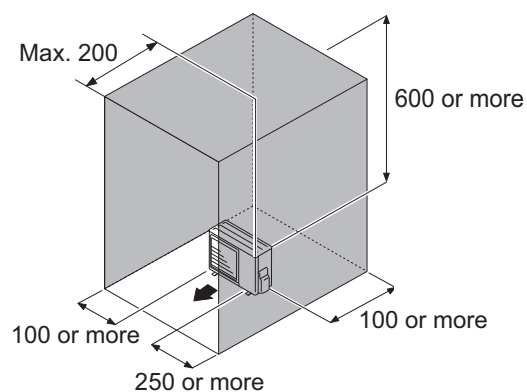

● Multiple outdoor unit installation

- Provide at least 250 mm of space between the outdoor units if multiple units are installed.
- When routing the piping from the side of an outdoor unit, provide space for piping.
- No more than 3 units must be installed side by side.
When 4 units or more are arranged in a line, provide the space as shown in the following example **“When an obstruction in the upper space:”**.
- **When the upper space is open:**

Unit: mm

Obstacles at rear only

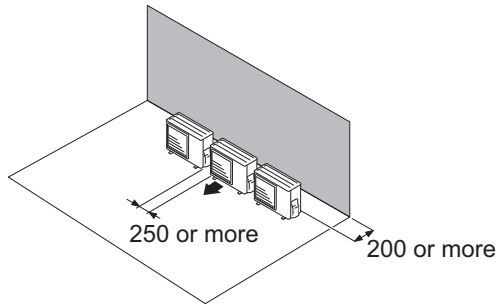

Obstacles at front only

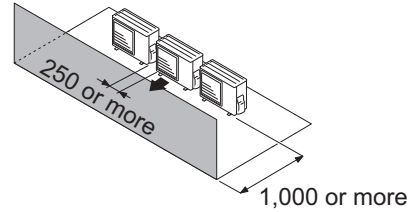

Obstacles at front and rear

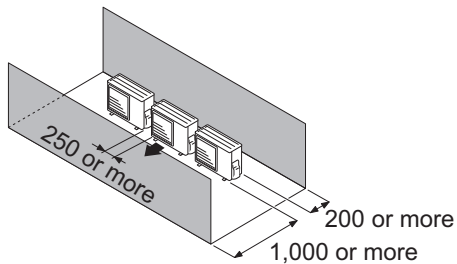

- **When an obstruction in the upper space:**

Unit: mm

Obstacles at rear and above.

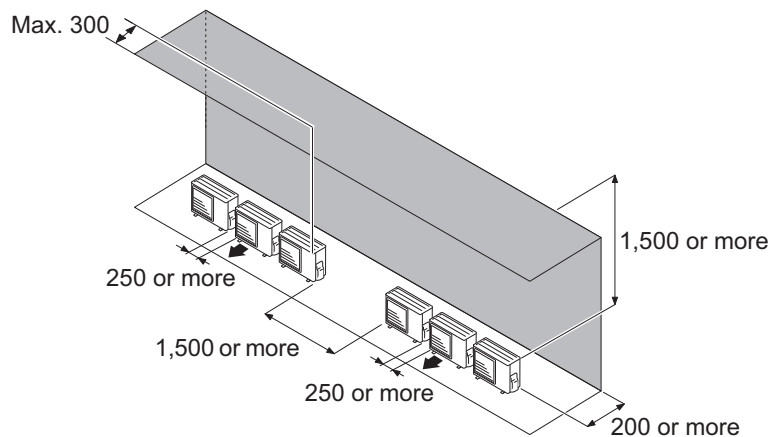

● Outdoor units installation in multi-row

Unit: mm

Single parallel unit arrangement

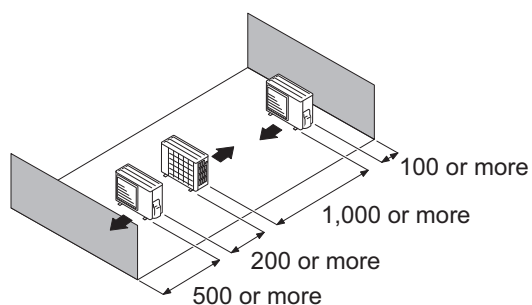

Multiple parallel unit arrangement

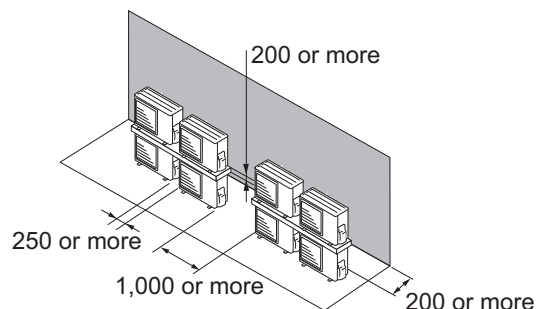
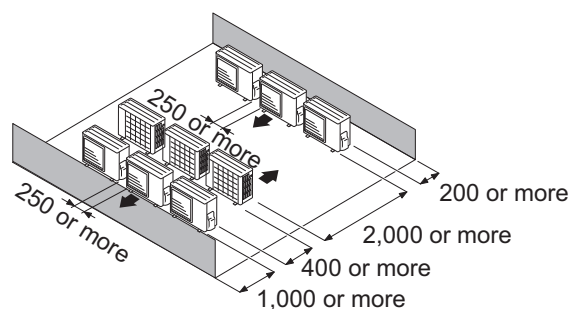

NOTES:

- If the space is larger than stated above, the condition will be the same as when there is no obstacle.
- When installing the outdoor unit, be sure to open the front and left side to obtain better operation efficiency.

⚠ CAUTION

- Do not install the outdoor unit in two-stage where the drain water could freeze. Otherwise the drainage from the upper unit may form ice and cause a malfunction of the lower unit.
- When the outdoor temperature is 0 °C or less, do not use the accessory drain pipe and drain cap. If the drain pipe and drain cap are used, the drain water in the pipe may freeze in extremely cold climate. (For reverse cycle model only.)
- In area with heavy snowfall, if the inlet and outlet of the outdoor unit is blocked with snow, it might become difficult to get warm, and it is likely to cause product malfunction. Construct a canopy and a pedestal, or place the unit on a high stand that is locally installed.

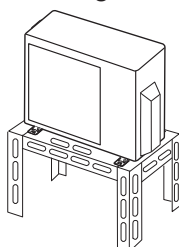

4. Refrigerant circuit

4-1. Model: AOEG14KBCA2

OUTDOOR UNIT

OUTDOOR UNIT

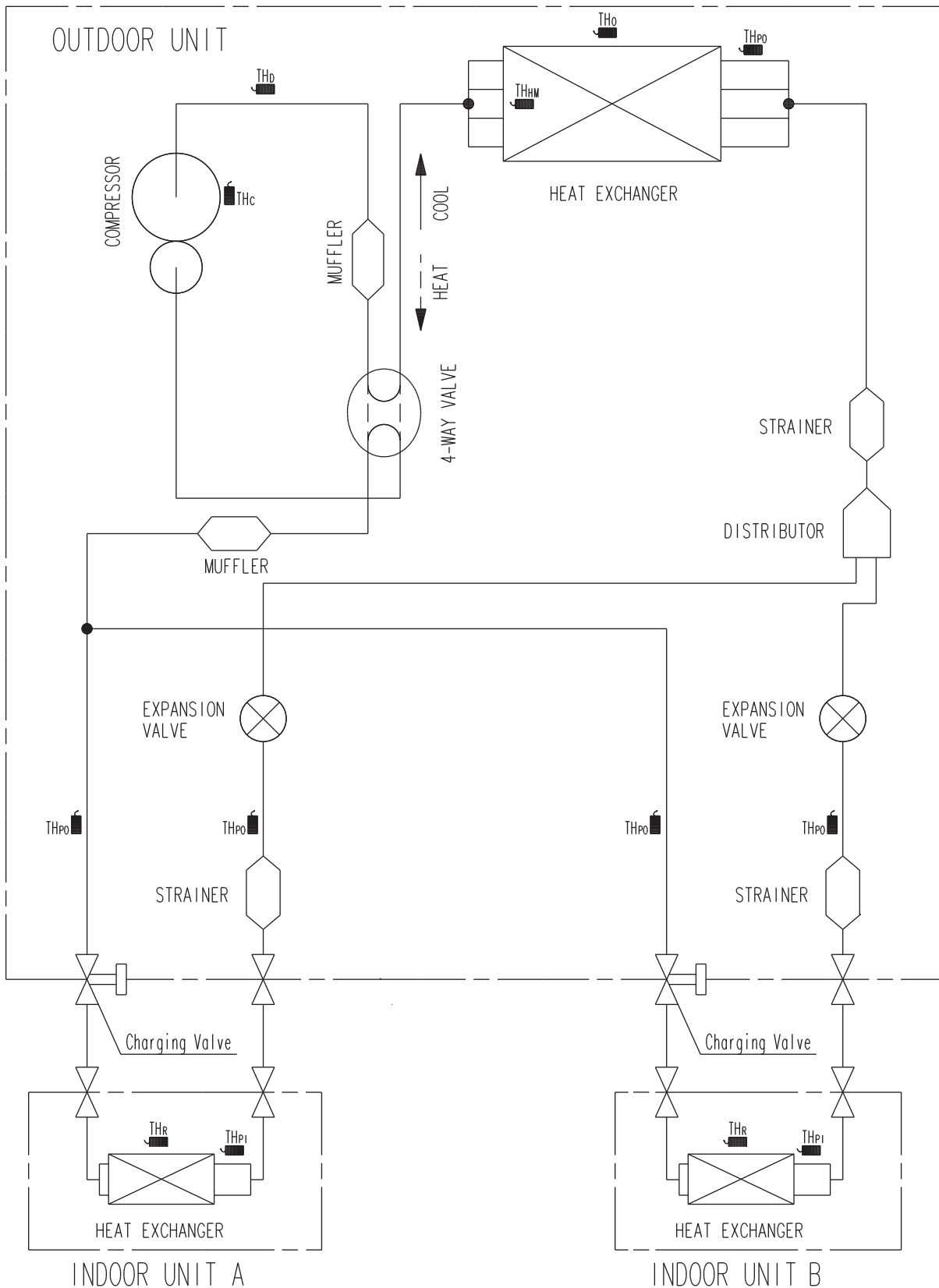

- TH_o : THERMISTOR(DISCHARGE TEMP.)
- TH_o : THERMISTOR(OUTDOOR TEMP.)
- TH_{po} : THERMISTOR(PIPE TEMP.)
- TH_{HM} : THERMISTOR(HEAT EXCHANGER MIDDLE TEMP.)
- TH_c : THERMISTOR(COMPRESSOR TEMP.)

- TH_R : THERMISTOR(ROOM TEMP.)
- TH_{PI} : THERMISTOR(PIPE TEMP.)

4-2. Model: AOEG18KBCA2

OUTDOOR UNIT

OUTDOOR UNIT

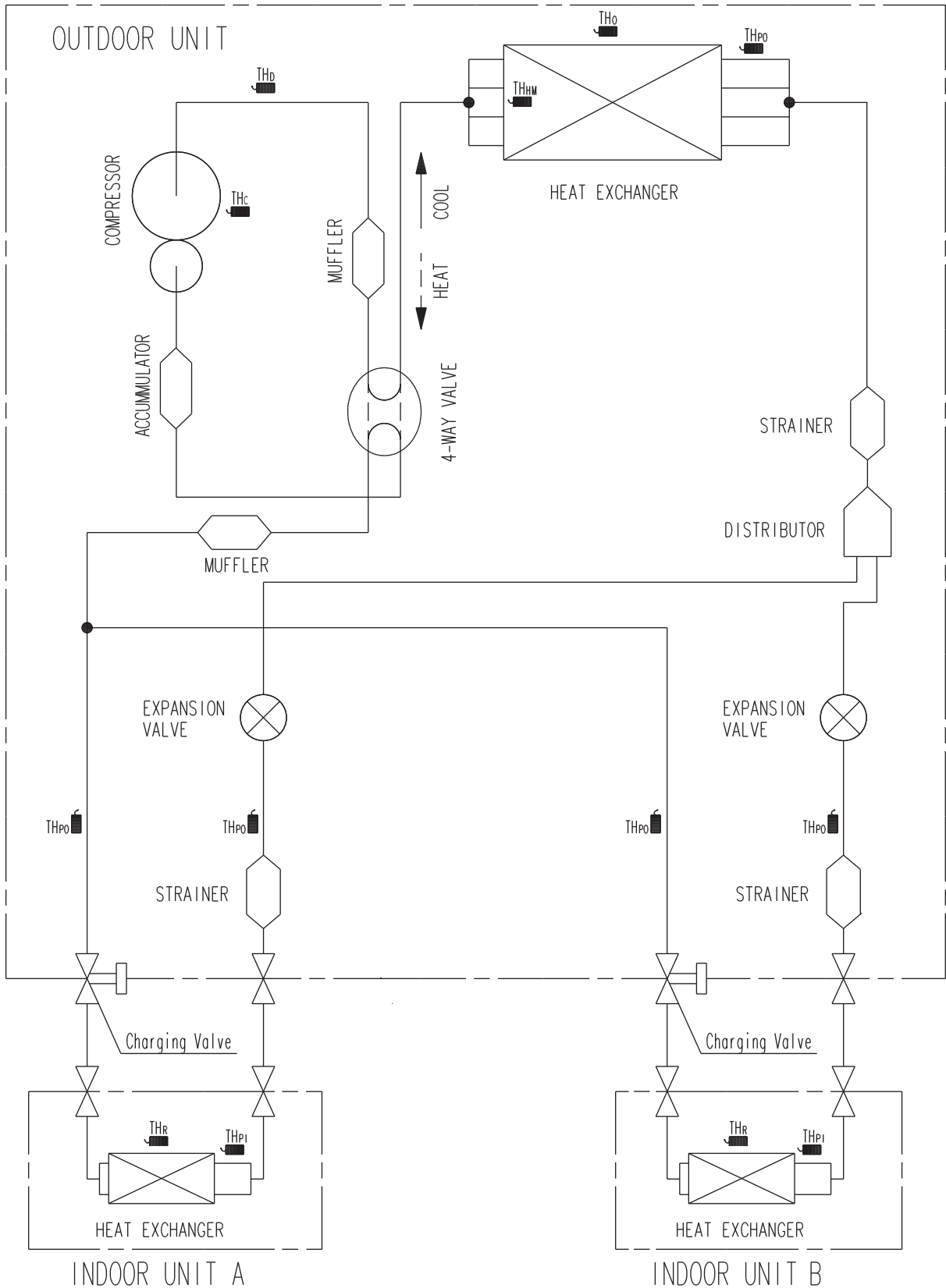

TH_D : THERMISTOR(DISCHARGE TEMP.)
 TH_o : THERMISTOR(OUTDOOR TEMP.)
 TH_{p1} : THERMISTOR(PIPE TEMP.)
 TH_{p2} : THERMISTOR(PIPE TEMP.)
 TH_w : THERMISTOR(HEAT EXCHANGER MIDDLE TEMP.)

TH_r : THERMISTOR(ROOM TEMP.)
 TH_{p1} : THERMISTOR(PIPE TEMP.)
 TH_c : THERMISTOR(COMPRESSOR TEMP.)

5. Wiring diagram

5-1. Model: AOEG14KBCA2

OUTDOOR UNIT

OUTDOOR UNIT

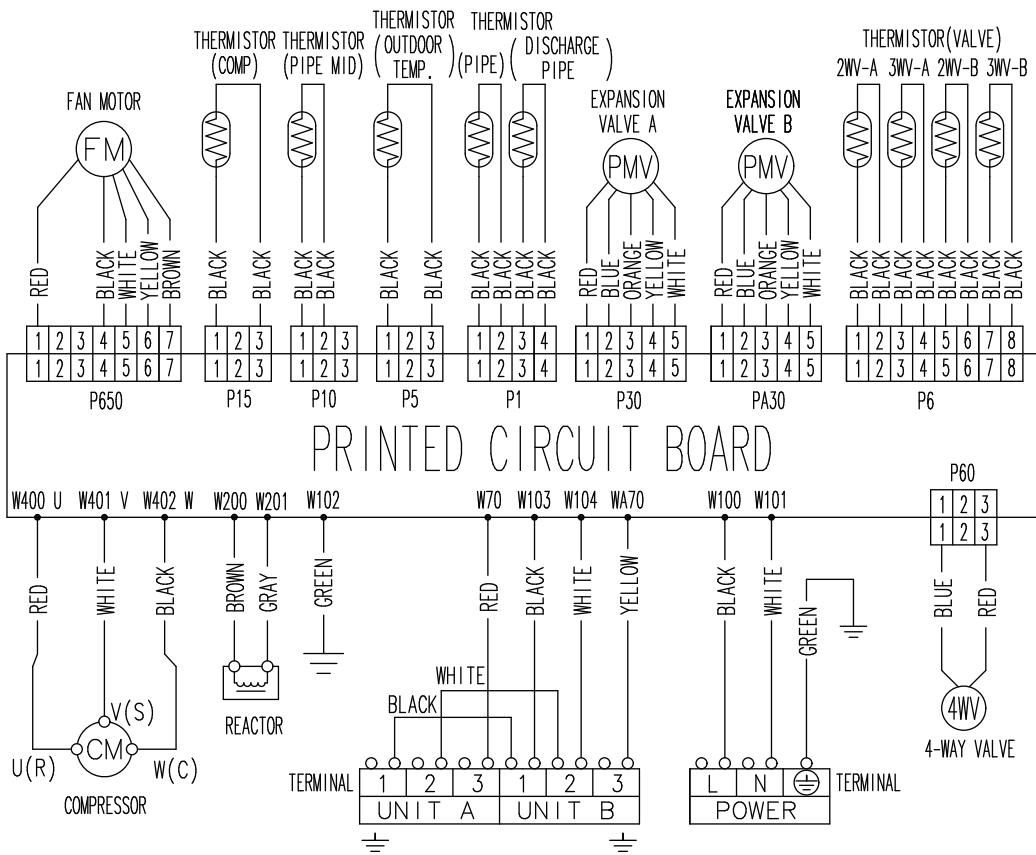

5-2. Model: AOEG18KBCA2

OUTDOOR UNIT

OUTDOOR UNIT

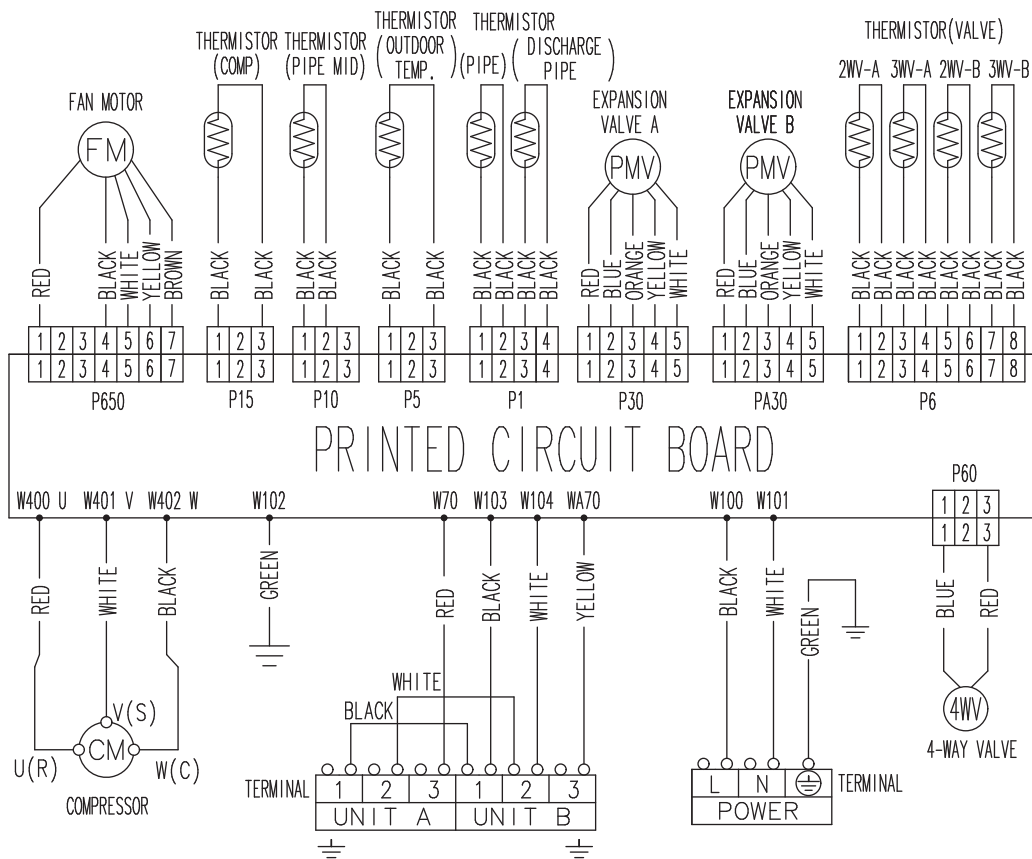

6. Capacity table

6-1. Combinations

■ Model: AOEG14KBCA2

● Cooling

Indoor unit combination (Wall-mounted KG/KM type only)

Combination of indoor unit			Rated capacity for each indoor unit (kW)		Total capacity (kW)			Input power (kW)			EER (W/W)	Seasonal data		
Unit		Total	Unit		Min.	Rated	Max.	Min.	Rated	Max.		Pdesign (kW)	SEER (kWh/kWh)	Energy efficiency class
1	2		1	2										
7	7	14	2.00	2.00	1.4	4.00	4.60	0.25	0.97	1.20	4.12	4.0	8.7	A+++
7	9	16	1.75	2.25	1.4	4.00	4.60	0.25	0.97	1.20	4.12	4.0	8.7	A+++
7	12	19	1.47	2.53	1.4	4.00	4.60	0.25	0.97	1.20	4.12	4.0	8.7	A+++
9	9	18	2.00	2.00	1.4	4.00	4.60	0.25	0.97	1.20	4.12	4.0	8.7	A+++
9	12	21	1.71	2.29	1.4	4.00	4.60	0.25	0.97	1.20	4.12	4.0	8.7	A+++

Indoor unit combination (All models other than wall-mounted type KG/KM models)

Combination of indoor unit			Rated capacity for each indoor unit (kW)		Total capacity (kW)			Input power (kW)			EER (W/W)	Seasonal data		
Unit		Total	Unit		Min.	Rated	Max.	Min.	Rated	Max.		Pdesign (kW)	SEER (kWh/kWh)	Energy efficiency class
1	2		1	2										
5	5	10	1.50	1.50	1.4	3.00	3.60	0.25	0.74	0.95	4.03	3.0	6.8	A++
5	7	12	1.50	2.00	1.4	3.50	4.30	0.25	0.84	1.10	4.15	3.5	6.8	A++
5	9	14	1.50	2.50	1.4	4.00	4.39	0.25	1.07	1.25	3.75	4.0	6.8	A++
5	12	17	1.18	2.82	1.4	4.00	4.61	0.25	1.02	1.25	3.92	4.0	6.8	A++
7	7	14	2.00	2.00	1.4	4.00	4.60	0.25	1.02	1.25	3.92	4.0	6.8	A++
7	9	16	1.75	2.25	1.4	4.00	4.60	0.25	1.02	1.25	3.92	4.0	6.8	A++
7	12	19	1.47	2.53	1.4	4.00	4.60	0.25	1.02	1.25	3.92	4.0	6.8	A++
9	9	18	2.00	2.00	1.4	4.00	4.60	0.25	1.02	1.25	3.92	4.0	6.8	A++
9	12	21	1.71	2.29	1.4	4.00	4.60	0.25	1.02	1.25	3.92	4.0	6.8	A++

NOTES:

- 5: 5,000 Btu/h, 7: 7,000 Btu/h, 9: 9,000 Btu/h, 12: 12,000 Btu/h
- The above is the value for connecting with KG models in wall mounted type.
- 2 or more indoor units should be connected.
- Cooling: Indoor temperature of 27 °CDB/19 °CWB and outdoor temperature of 35 °CDB.
- Pipe length: 5 m, Height difference: 0 m (Outdoor unit—Indoor unit)
- The total ability of connected indoor unit is from 10,000 Btu/h up to 21,000 Btu/h.

● Heating

Indoor unit combination (Wall-mounted KG/KM type only)

Combination of indoor unit			Rated capacity for each indoor unit (kBtu/h)		Total capacity (kBtu/h)			Input power (kW)			COP (W/W)	Seasonal data		
Unit		Total	Unit		Min.	Rated	Max.	Min.	Rated	Max.		Pdesign (kW)	SCOP (kWh/kWh)	Energy efficiency class
1	2		1	2										
7	7	14	2.20	2.20	1.1	4.40	5.5	0.25	0.95	1.65	4.63	3.5	4.7	A++
7	9	16	1.92	2.48	1.1	4.40	5.5	0.25	0.95	1.65	4.63	3.5	4.7	A++
7	12	19	1.62	2.78	1.1	4.40	5.5	0.25	0.95	1.65	4.63	3.5	4.7	A++
9	9	18	2.20	2.20	1.1	4.40	5.5	0.25	0.95	1.65	4.63	3.5	4.7	A++
9	12	21	1.89	2.51	1.1	4.40	5.5	0.25	0.95	1.65	4.63	3.5	4.7	A++

Indoor unit combination (All models other than wall-mounted type KG/KM models)

Combination of indoor unit			Rated capacity for each indoor unit (kBtu/h)		Total capacity (kBtu/h)			Input power (kW)			COP (W/W)	Seasonal data		
Unit		Total	Unit		Min.	Rated	Max.	Min.	Rated	Max.		Pdesign (kW)	SCOP (kWh/kWh)	Energy efficiency class
1	2		1	2										
5	5	10	1.80	1.80	1.1	3.60	4.2	0.25	0.80	1.25	4.52	2.9	4.08	A+
5	7	12	1.67	2.33	1.1	4.00	4.8	0.25	0.92	1.50	4.36	3.4	4.10	A+
5	9	14	1.57	2.83	1.1	4.40	5.1	0.25	1.06	1.70	4.16	3.5	4.10	A+
5	12	17	1.29	3.11	1.1	4.40	5.4	0.25	1.01	1.70	4.34	3.5	4.10	A+
7	7	14	2.20	2.20	1.1	4.40	5.5	0.25	1.00	1.70	4.40	3.5	4.10	A+
7	9	16	1.92	2.48	1.1	4.40	5.5	0.25	1.00	1.70	4.40	3.5	4.10	A+
7	12	19	1.62	2.78	1.1	4.40	5.5	0.25	1.00	1.70	4.40	3.5	4.10	A+
9	9	18	2.20	2.20	1.1	4.40	5.5	0.25	1.00	1.70	4.40	3.5	4.1	A+
9	12	21	1.89	2.51	1.1	4.40	5.5	0.25	1.00	1.70	4.40	3.5	4.1	A+

NOTES:

- 5: 5,000 Btu/h, 7: 7,000 Btu/h, 9: 9,000 Btu/h, 12: 12,000 Btu/h
- The above is the value for connecting with KG models in wall mounted type.
- 2 or more indoor units should be connected.
- Heating: Indoor temperature of 20 °CDB, and outdoor temperature of 7 °CDB/6 °CWB.
- Pipe length: 5 m, Height difference: 0 m (Outdoor unit—Indoor unit)
- The total ability of connected indoor unit is from 10,000 Btu/h up to 21,000 Btu/h.

Model: AOEG18KBCA2

● Cooling

Indoor unit combination (Wall-mounted KG/KM type only)

Combination of indoor unit			Rated capacity for each indoor unit (kW)		Total capacity (kW)			Input power (kW)			EER (W/W)	Seasonal data		
Unit		Total	Unit		Min.	Rated	Max.	Min.	Rated	Max.		Pdesign (kW)	SEER (kWh/kWh)	Energy efficiency class
1	2		1	2										
7	7	14	2.00	2.00	1.7	4.00	5.0	0.25	0.92	1.23	4.35	4.0	8.8	A+++
7	9	16	2.00	2.50	1.7	4.50	5.7	0.25	1.07	1.45	4.22	4.5	8.7	A+++
7	12	19	1.84	3.16	1.7	5.00	5.8	0.25	1.24	1.55	4.03	5.0	8.6	A+++
7	14	21	1.67	3.33	1.7	5.00	5.8	0.25	1.24	1.55	4.03	5.0	8.6	A+++
9	9	18	2.50	2.50	1.7	5.00	5.8	0.25	1.24	1.55	4.03	5.0	8.6	A+++
9	12	21	2.14	2.86	1.7	5.00	5.8	0.25	1.24	1.55	4.03	5.0	8.6	A+++
9	14	23	1.96	3.04	1.7	5.00	5.8	0.25	1.24	1.55	4.03	5.0	8.6	A+++
12	12	24	2.50	2.50	1.7	5.00	5.8	0.25	1.24	1.55	4.03	5.0	8.6	A+++
12	14	26	2.31	2.69	1.7	5.00	5.8	0.25	1.24	1.55	4.03	5.0	8.6	A+++

Indoor unit combination (All models other than wall-mounted type KG/KM models)

Combination of indoor unit			Rated capacity for each indoor unit (kW)		Total capacity (kW)			Input power (kW)			EER (W/W)	Seasonal data		
Unit		Total	Unit		Min.	Rated	Max.	Min.	Rated	Max.		Pdesign (kW)	SEER (kWh/kWh)	Energy efficiency class
1	2		1	2										
5	5	10	1.50	1.50	1.7	3.00	3.60	0.25	0.53	0.94	5.65	3.0	6.9	A++
5	7	12	1.50	2.00	1.7	3.50	4.30	0.25	0.75	1.12	4.65	3.5	6.9	A++
5	9	14	1.50	2.50	1.7	4.00	5.00	0.25	0.97	1.29	4.10	4.0	6.9	A++
5	12	17	1.41	3.39	1.7	4.80	5.70	0.25	1.20	1.58	4.00	5.0	6.7	A++
5	14	19	1.32	3.68	1.7	5.00	5.80	0.25	1.32	1.63	3.78	5.0	6.7	A++
7	7	14	2.00	2.00	1.7	4.00	5.00	0.25	0.97	1.29	4.10	4.0	6.9	A++
7	9	16	2.00	2.50	1.7	4.50	5.70	0.25	1.20	1.58	3.75	4.5	6.8	A++
7	12	19	1.84	3.16	1.7	5.00	5.80	0.25	1.32	1.63	3.79	5.0	6.7	A++
7	14	21	1.67	3.33	1.7	5.00	5.80	0.25	1.32	1.63	3.79	5.0	6.7	A++
9	9	18	2.50	2.50	1.7	5.00	5.80	0.25	1.32	1.63	3.79	5.0	6.7	A++
9	12	21	2.14	2.86	1.7	5.00	5.80	0.25	1.32	1.63	3.79	5.0	6.7	A++
9	14	23	1.96	3.04	1.7	5.00	5.80	0.25	1.32	1.63	3.79	5.0	6.7	A++
12	12	24	2.50	2.50	1.7	5.00	5.80	0.25	1.32	1.63	3.79	5.0	6.7	A++
12	14	26	2.31	2.69	1.7	5.00	5.80	0.25	1.32	1.63	3.79	5.0	6.7	A++

NOTES:

- 5: 5,000 Btu/h, 7: 7,000 Btu/h, 9: 9,000 Btu/h, 12: 12,000 Btu/h, 14: 14,000 Btu/h
- The above is the value for connecting with KG models in wall mounted type.
- 2 or more indoor units should be connected.
- Cooling: Indoor temperature of 27 °CDB/19 °CWB and outdoor temperature of 35 °CDB.
- Pipe length: 5 m, Height difference: 0 m (Outdoor unit—Indoor unit)
- The total ability of connected indoor units is from 10,000 Btu/h up to 26,000 Btu/h.

● Heating

Indoor unit combination (Wall-mounted KG/KM type only)

Combination of indoor unit			Rated capacity for each indoor unit (kW)		Total capacity (kW)			Input power (kW)			COP (W/W)	Seasonal data		
Unit		Total	Unit		Min.	Rated	Max.	Min.	Rated	Max.		Pdesign (kW)	SCOP (kWh/kWh)	Energy efficiency class
1	2		1	2										
7	7	14	2.40	2.40	1.7	4.80	5.60	0.25	0.99	1.35	4.85	3.8	4.7	A++
7	9	16	2.40	3.00	1.7	5.40	6.40	0.25	1.15	1.60	4.70	4.0	4.7	A++
7	12	19	2.06	3.54	1.7	5.60	7.00	0.25	1.22	1.80	4.59	4.2	4.7	A++
7	14	21	1.87	3.73	1.7	5.60	7.00	0.25	1.22	1.80	4.59	4.2	4.7	A++
9	9	18	2.80	2.80	1.7	5.60	7.00	0.25	1.22	1.80	4.59	4.2	4.7	A++
9	12	21	2.40	3.20	1.7	5.60	7.00	0.25	1.22	1.80	4.59	4.2	4.7	A++
9	14	23	2.19	3.41	1.7	5.60	7.00	0.25	1.22	1.80	4.59	4.2	4.7	A++
12	12	24	2.80	2.80	1.7	5.60	7.00	0.25	1.22	1.80	4.59	4.2	4.7	A++
12	14	26	2.58	3.02	1.7	5.60	7.00	0.25	1.22	1.80	4.59	4.2	4.7	A++

Indoor unit combination (All models other than wall-mounted type KG/KM models)

Combination of indoor unit			Rated capacity for each indoor unit (kW)		Total capacity (kW)			Input power (kW)			COP (W/W)	Seasonal data		
Unit		Total	Unit		Min.	Rated	Max.	Min.	Rated	Max.		Pdesign (kW)	SCOP (kWh/kWh)	Energy efficiency class
1	2		1	2										
5	5	10	1.80	1.80	1.7	3.60	4.20	0.25	0.80	0.94	4.50	2.9	4.1	A+
5	7	12	1.80	2.40	1.7	4.20	4.90	0.25	0.92	1.18	4.54	3.4	4.1	A+
5	9	14	1.80	3.00	1.7	4.80	5.60	0.25	1.05	1.41	4.57	3.8	4.1	A+
5	12	17	1.59	3.81	1.7	5.40	6.40	0.25	1.24	1.76	4.36	4.2	4.0	A+
5	14	19	1.47	4.13	1.7	5.60	6.60	0.25	1.30	1.88	4.30	4.2	4.0	A+
7	7	14	2.40	2.40	1.7	4.80	5.60	0.25	1.05	1.41	4.57	3.8	4.1	A+
7	9	16	2.40	3.00	1.7	5.40	6.40	0.25	1.23	1.68	4.39	4.0	4.0	A+
7	12	19	2.06	3.54	1.7	5.60	7.00	0.25	1.30	1.88	4.30	4.2	4.0	A+
7	14	21	1.87	3.73	1.7	5.60	7.00	0.25	1.30	1.88	4.30	4.2	4.0	A+
9	9	18	2.80	2.80	1.7	5.60	7.00	0.25	1.30	1.88	4.30	4.2	4.0	A+
9	12	21	2.40	3.20	1.7	5.60	7.00	0.25	1.30	1.88	4.30	4.2	4.0	A+
9	14	23	2.19	3.41	1.7	5.60	7.00	0.25	1.30	1.88	4.30	4.2	4.0	A+
12	12	24	2.80	2.80	1.7	5.60	7.00	0.25	1.30	1.88	4.30	4.2	4.0	A+
12	14	26	2.58	3.02	1.7	5.60	7.00	0.25	1.30	1.88	4.30	4.2	4.0	A+

NOTES:

- 5: 5,000 Btu/h, 7: 7,000 Btu/h, 9: 9,000 Btu/h, 12: 12,000 Btu/h, 14: 14,000 Btu/h
- The above is the value for connecting with KG models in wall mounted type.
- 2 or more indoor units should be connected.
- Heating: Indoor temperature of 20 °CDB, and outdoor temperature of 7 °CDB/6 °CWB.
- Pipe length: 5 m, Height difference: 0 m (Outdoor unit—Indoor unit)
- The total ability of connected indoor units is from 10,000 Btu/h up to 26,000 Btu/h.

6-2. Cooling capacity

NOTE: Values mentioned in the table are calculated based on the maximum capacity.

Model: AOEG14KBCA2

Indoor unit connect- ing capacity	Outdoor temperature	Indoor temperature											
		18.0 °CDB		21.0 °CDB		23.0 °CDB		27.0 °CDB		29.0 °CDB		32.0 °CDB	
		12.0 °CWB		15.0 °CWB		16.0 °CWB		19.0 °CWB		21.0 °CWB		23.0 °CWB	
kBtu/h	°CDB	TC	IP	TC	IP	TC	IP	TC	IP	TC	IP	TC	IP
21	-10.0	3.60	0.63	4.10	0.64	4.30	0.64	4.60	0.65	4.90	0.66	5.10	0.66
	0.0	3.60	0.28	4.10	0.28	4.30	0.28	4.60	0.29	4.90	0.29	5.10	0.29
	5.0	3.60	0.45	4.10	0.46	4.30	0.46	4.60	0.47	4.90	0.47	5.10	0.47
	10.0	3.60	0.38	4.10	0.38	4.30	0.38	4.60	0.39	4.90	0.39	5.10	0.40
	15.0	3.60	0.50	4.10	0.51	4.30	0.51	4.60	0.52	4.90	0.52	5.10	0.53
	20.0	3.60	0.59	4.10	0.60	4.30	0.61	4.60	0.62	4.90	0.62	5.10	0.63
	25.0	3.60	0.76	4.10	0.78	4.30	0.78	4.60	0.79	4.90	0.80	5.10	0.81
	30.0	3.60	0.91	4.10	0.93	4.30	0.94	4.60	0.95	4.90	0.96	5.10	0.96
	35.0	3.60	1.21	4.10	1.23	4.30	1.24	4.60	1.25	4.90	1.26	5.10	1.27
	40.0	3.10	1.00	3.50	1.02	3.70	1.03	4.00	1.04	4.30	1.05	4.40	1.06
46.0	2.70	1.01	3.10	1.03	3.20	1.04	3.50	1.05	3.70	1.06	3.80	1.07	
19	-10.0	3.60	0.63	4.10	0.64	4.30	0.64	4.60	0.65	4.90	0.66	5.10	0.66
	0.0	3.60	0.28	4.10	0.28	4.30	0.28	4.60	0.29	4.90	0.29	5.10	0.29
	5.0	3.60	0.45	4.10	0.46	4.30	0.46	4.60	0.47	4.90	0.47	5.10	0.47
	10.0	3.60	0.38	4.10	0.38	4.30	0.38	4.60	0.39	4.90	0.39	5.10	0.40
	15.0	3.60	0.50	4.10	0.51	4.30	0.51	4.60	0.52	4.90	0.52	5.10	0.53
	20.0	3.60	0.59	4.10	0.60	4.30	0.61	4.60	0.62	4.90	0.62	5.10	0.63
	25.0	3.60	0.76	4.10	0.78	4.30	0.78	4.60	0.79	4.90	0.80	5.10	0.81
	30.0	3.60	0.91	4.10	0.93	4.30	0.94	4.60	0.95	4.90	0.96	5.10	0.96
	35.0	3.60	1.21	4.10	1.23	4.30	1.24	4.60	1.25	4.90	1.26	5.10	1.27
	40.0	3.10	1.00	3.50	1.02	3.70	1.03	4.00	1.04	4.30	1.05	4.40	1.06
46.0	2.70	1.01	3.10	1.03	3.20	1.04	3.50	1.05	3.70	1.06	3.80	1.07	
18	-10.0	3.60	0.63	4.10	0.64	4.30	0.64	4.60	0.65	4.90	0.66	5.10	0.66
	0.0	3.60	0.28	4.10	0.28	4.30	0.28	4.60	0.29	4.90	0.29	5.10	0.29
	5.0	3.60	0.45	4.10	0.46	4.30	0.46	4.60	0.47	4.90	0.47	5.10	0.47
	10.0	3.60	0.38	4.10	0.38	4.30	0.38	4.60	0.39	4.90	0.39	5.10	0.40
	15.0	3.60	0.50	4.10	0.51	4.30	0.51	4.60	0.52	4.90	0.52	5.10	0.53
	20.0	3.60	0.59	4.10	0.60	4.30	0.61	4.60	0.62	4.90	0.62	5.10	0.63
	25.0	3.60	0.76	4.10	0.78	4.30	0.78	4.60	0.79	4.90	0.80	5.10	0.81
	30.0	3.60	0.91	4.10	0.93	4.30	0.94	4.60	0.95	4.90	0.96	5.10	0.96
	35.0	3.60	1.21	4.10	1.23	4.30	1.24	4.60	1.25	4.90	1.26	5.10	1.27
	40.0	3.10	1.00	3.50	1.02	3.70	1.03	4.00	1.04	4.30	1.05	4.40	1.06
46.0	2.70	1.01	3.10	1.03	3.20	1.04	3.50	1.05	3.70	1.06	3.80	1.07	
17	-10.0	3.61	0.43	4.08	0.44	4.30	0.44	4.60	0.44	4.92	0.45	5.07	0.45
	0.0	3.61	0.28	4.08	0.28	4.30	0.28	4.60	0.29	4.92	0.29	5.07	0.29
	5.0	3.61	0.45	4.08	0.46	4.30	0.46	4.60	0.47	4.92	0.47	5.07	0.47
	10.0	3.61	0.38	4.08	0.38	4.30	0.38	4.60	0.39	4.92	0.39	5.07	0.40
	15.0	3.61	0.50	4.08	0.51	4.30	0.51	4.60	0.52	4.92	0.52	5.07	0.53
	20.0	3.61	0.59	4.08	0.60	4.30	0.61	4.60	0.62	4.92	0.62	5.07	0.63
	25.0	3.61	0.76	4.08	0.78	4.30	0.78	4.60	0.79	4.92	0.80	5.07	0.81
	30.0	3.61	0.91	4.08	0.93	4.30	0.94	4.60	0.95	4.92	0.96	5.07	0.96
	35.0	3.61	1.21	4.08	1.23	4.30	1.24	4.60	1.25	4.92	1.26	5.07	1.27
	40.0	3.13	1.00	3.54	1.02	3.73	1.03	3.99	1.04	4.27	1.05	4.40	1.06
46.0	2.72	1.01	3.08	1.03	3.24	1.04	3.47	1.05	3.71	1.06	3.83	1.07	
14	-10.0	3.60	0.63	4.10	0.64	4.30	0.64	4.60	0.65	4.90	0.66	5.10	0.66
	0.0	3.60	0.28	4.10	0.28	4.30	0.28	4.60	0.29	4.90	0.29	5.10	0.29
	5.0	3.60	0.45	4.10	0.46	4.30	0.46	4.60	0.47	4.90	0.47	5.10	0.47
	10.0	3.60	0.38	4.10	0.38	4.30	0.38	4.60	0.39	4.90	0.39	5.10	0.40
	15.0	3.60	0.50	4.10	0.51	4.30	0.51	4.60	0.52	4.90	0.52	5.10	0.53
	20.0	3.60	0.59	4.10	0.60	4.30	0.61	4.60	0.62	4.90	0.62	5.10	0.63
	25.0	3.60	0.76	4.10	0.78	4.30	0.78	4.60	0.79	4.90	0.80	5.10	0.81
	30.0	3.60	0.91	4.10	0.93	4.30	0.94	4.60	0.95	4.90	0.96	5.10	0.96
	35.0	3.60	1.21	4.10	1.23	4.30	1.24	4.60	1.25	4.90	1.26	5.10	1.27
	40.0	3.10	1.00	3.50	1.02	3.70	1.03	4.00	1.04	4.30	1.05	4.40	1.06
46.0	2.70	1.01	3.10	1.03	3.20	1.04	3.50	1.05	3.70	1.06	3.80	1.07	
12	-10.0	3.37	0.38	3.81	0.38	4.02	0.39	4.30	0.39	4.60	0.40	4.74	0.40
	0.0	3.37	0.24	3.81	0.25	4.02	0.25	4.30	0.25	4.60	0.26	4.74	0.26
	5.0	3.37	0.39	3.81	0.40	4.02	0.40	4.30	0.41	4.60	0.41	4.74	0.42
	10.0	3.37	0.33	3.81	0.34	4.02	0.34	4.30	0.34	4.60	0.35	4.74	0.35
	15.0	3.37	0.44	3.81	0.45	4.02	0.45	4.30	0.46	4.60	0.46	4.74	0.46
	20.0	3.37	0.52	3.81	0.53	4.02	0.54	4.30	0.54	4.60	0.55	4.74	0.55
	25.0	3.37	0.67	3.81	0.68	4.02	0.69	4.30	0.70	4.60	0.71	4.74	0.71
	30.0	3.37	0.80	3.81	0.82	4.02	0.82	4.30	0.83	4.60	0.84	4.74	0.85
	35.0	3.37	1.06	3.81	1.08	4.02	1.09	4.30	1.10	4.60	1.11	4.74	1.12
	40.0	3.13	1.00	3.54	1.02	3.73	1.03	3.99	1.04	4.27	1.05	4.40	1.06
46.0	2.72	1.01	3.08	1.03	3.24	1.04	3.47	1.05	3.71	1.06	3.83	1.07	
10	-10.0	2.82	0.33	3.19	0.33	3.36	0.33	3.60	0.34	3.85	0.34	3.97	0.34
	0.0	2.82	0.21	3.19	0.21	3.36	0.22	3.60	0.22	3.85	0.22	3.97	0.22
	5.0	2.82	0.34	3.19	0.35	3.36	0.35	3.60	0.35	3.85	0.36	3.97	0.36
	10.0	2.82	0.29	3.19	0.29	3.36	0.29	3.60	0.30	3.85	0.30	3.97	0.30
	15.0	2.82	0.38	3.19	0.39	3.36	0.39	3.60	0.39	3.85	0.40	3.97	0.40
	20.0	2.82	0.45	3.19	0.46	3.36	0.46	3.60	0.47	3.85	0.47	3.97	0.48
	25.0	2.82	0.58	3.19	0.59	3.36	0.60	3.60	0.60	3.85	0.61	3.97	0.61
	30.0	2.82	0.69	3.19	0.70	3.36	0.71	3.60	0.72	3.85	0.73	3.97	0.73
	35.0	2.82	0.92	3.19	0.93	3.36	0.94	3.60	0.95	3.85	0.96	3.97	0.97
	40.0	3.13	1.00	3.54	1.02	3.73	1.03	3.99	1.04	4.27	1.05	4.40	1.06
46.0	2.72	1.01	3.08	1.03	3.24	1.04	3.47	1.05	3.71	1.06	3.83	1.07	

NOTES:

- TC: Total Capacity (kW), IP: Input Power (kW)
- Values mentioned in the table are based on the following conditions:
 - Power source of specifications: 230 V
 - Pipe length: 5 m, Height difference: 0 m (Outdoor unit—Indoor unit)
- 2 or more indoor units should be connected.
- The total ability of connected indoor unit is from 10,000 Btu/h up to 21,000 Btu/h.
- Input in the table are calculated based on the maximum indoor unit input combinations.

● Compact cassette type

Model: AUXG07KVLA

Outdoor temperature	Indoor temperature (°CDB / °CWB)											
	18.0 / 12.0		21.0 / 15.0		23.0 / 16.0		27.0 / 19.0		29.0 / 21.0		32.0 / 23.0	
(°CDB)	TC	SHC	TC	SHC	TC	SHC	TC	SHC	TC	SHC	TC	SHC
-10.0	1.80	1.22	2.04	1.39	2.15	1.60	2.30	1.79	2.46	1.96	2.53	2.25
0.0	1.80	1.22	2.04	1.39	2.15	1.60	2.30	1.79	2.46	1.96	2.53	2.25
5.0	1.80	1.22	2.04	1.39	2.15	1.60	2.30	1.79	2.46	1.96	2.53	2.25
10.0	1.80	1.22	2.04	1.39	2.15	1.60	2.30	1.79	2.46	1.96	2.53	2.25
15.0	1.80	1.22	2.04	1.39	2.15	1.60	2.30	1.79	2.46	1.96	2.53	2.25
20.0	1.80	1.22	2.04	1.39	2.15	1.60	2.30	1.79	2.46	1.96	2.53	2.25
25.0	1.80	1.22	2.04	1.39	2.15	1.60	2.30	1.79	2.46	1.96	2.53	2.25
30.0	1.80	1.22	2.04	1.39	2.15	1.60	2.30	1.79	2.46	1.96	2.53	2.25
35.0	1.80	1.22	2.04	1.39	2.15	1.60	2.30	1.79	2.46	1.96	2.53	2.25
40.0	1.57	0.92	1.77	1.05	1.87	1.20	2.00	1.35	2.13	1.48	2.20	1.69
46.0	1.36	0.69	1.54	0.79	1.62	0.91	1.74	1.02	1.86	1.12	1.91	1.28

Model: AUXG09KVLA

Outdoor temperature	Indoor temperature (°CDB / °CWB)											
	18.0 / 12.0		21.0 / 15.0		23.0 / 16.0		27.0 / 19.0		29.0 / 21.0		32.0 / 23.0	
(°CDB)	TC	SHC	TC	SHC	TC	SHC	TC	SHC	TC	SHC	TC	SHC
-10.0	2.03	1.35	2.29	1.54	2.42	1.78	2.59	1.99	2.77	2.18	2.85	2.50
0.0	2.03	1.35	2.29	1.54	2.42	1.78	2.59	1.99	2.77	2.18	2.85	2.50
5.0	2.03	1.35	2.29	1.54	2.42	1.78	2.59	1.99	2.77	2.18	2.85	2.50
10.0	2.03	1.35	2.29	1.54	2.42	1.78	2.59	1.99	2.77	2.18	2.85	2.50
15.0	2.03	1.35	2.29	1.54	2.42	1.78	2.59	1.99	2.77	2.18	2.85	2.50
20.0	2.03	1.35	2.29	1.54	2.42	1.78	2.59	1.99	2.77	2.18	2.85	2.50
25.0	2.03	1.35	2.29	1.54	2.42	1.78	2.59	1.99	2.77	2.18	2.85	2.50
30.0	2.03	1.35	2.29	1.54	2.42	1.78	2.59	1.99	2.77	2.18	2.85	2.50
35.0	2.03	1.35	2.29	1.54	2.42	1.78	2.59	1.99	2.77	2.18	2.85	2.50
40.0	1.76	1.02	1.99	1.16	2.10	1.34	2.25	1.50	2.40	1.64	2.48	1.88
46.0	1.53	0.77	1.73	0.88	1.83	1.01	1.96	1.14	2.09	1.24	2.16	1.43

Model: AUXG12KVLA

Outdoor temperature	Indoor temperature (°CDB / °CWB)											
	18.0 / 12.0		21.0 / 15.0		23.0 / 16.0		27.0 / 19.0		29.0 / 21.0		32.0 / 23.0	
(°CDB)	TC	SHC	TC	SHC	TC	SHC	TC	SHC	TC	SHC	TC	SHC
-10.0	2.28	1.50	2.58	1.71	2.72	1.97	2.91	2.21	3.11	2.42	3.21	2.77
0.0	2.28	1.50	2.58	1.71	2.72	1.97	2.91	2.21	3.11	2.42	3.21	2.77
5.0	2.28	1.50	2.58	1.71	2.72	1.97	2.91	2.21	3.11	2.42	3.21	2.77
10.0	2.28	1.50	2.58	1.71	2.72	1.97	2.91	2.21	3.11	2.42	3.21	2.77
15.0	2.28	1.50	2.58	1.71	2.72	1.97	2.91	2.21	3.11	2.42	3.21	2.77
20.0	2.28	1.50	2.58	1.71	2.72	1.97	2.91	2.21	3.11	2.42	3.21	2.77
25.0	2.28	1.50	2.58	1.71	2.72	1.97	2.91	2.21	3.11	2.42	3.21	2.77
30.0	2.28	1.50	2.58	1.71	2.72	1.97	2.91	2.21	3.11	2.42	3.21	2.77
35.0	2.28	1.50	2.58	1.71	2.72	1.97	2.91	2.21	3.11	2.42	3.21	2.77
40.0	1.98	1.13	2.24	1.29	2.36	1.48	2.53	1.67	2.70	1.82	2.78	2.09
46.0	1.72	0.86	1.95	0.97	2.05	1.12	2.20	1.26	2.35	1.38	2.42	1.58

NOTES:

- TC: Total Capacity (kW), SHC: Sensible Heat Capacity (kW)
- Values mentioned in the table are based on the following conditions:
 - Pipe length: 5 m, Height difference: 0 m (Outdoor unit—Indoor unit)

● Mini duct type

Model: ARXG07KSLAP

Outdoor temperature	Indoor temperature (°CDB / °CWB)											
	18.0 / 12.0		21.0 / 15.0		23.0 / 16.0		27.0 / 19.0		29.0 / 21.0		32.0 / 23.0	
(°CDB)	TC	SHC	TC	SHC	TC	SHC	TC	SHC	TC	SHC	TC	SHC
-10.0	1.80	1.25	2.04	1.42	2.15	1.64	2.30	1.84	2.46	2.01	2.53	2.31
0.0	1.80	1.25	2.04	1.42	2.15	1.64	2.30	1.84	2.46	2.01	2.53	2.31
5.0	1.80	1.25	2.04	1.42	2.15	1.64	2.30	1.84	2.46	2.01	2.53	2.31
10.0	1.80	1.25	2.04	1.42	2.15	1.64	2.30	1.84	2.46	2.01	2.53	2.31
15.0	1.80	1.25	2.04	1.42	2.15	1.64	2.30	1.84	2.46	2.01	2.53	2.31
20.0	1.80	1.25	2.04	1.42	2.15	1.64	2.30	1.84	2.46	2.01	2.53	2.31
25.0	1.80	1.25	2.04	1.42	2.15	1.64	2.30	1.84	2.46	2.01	2.53	2.31
30.0	1.80	1.25	2.04	1.42	2.15	1.64	2.30	1.84	2.46	2.01	2.53	2.31
35.0	1.80	1.25	2.04	1.42	2.15	1.64	2.30	1.84	2.46	2.01	2.53	2.31
40.0	1.57	0.94	1.77	1.07	1.87	1.23	2.00	1.39	2.13	1.52	2.20	1.74
46.0	1.36	0.71	1.54	0.81	1.62	0.93	1.74	1.05	1.86	1.15	1.91	1.31

Model: ARXG09KSLAP

Outdoor temperature	Indoor temperature (°CDB / °CWB)											
	18.0 / 12.0		21.0 / 15.0		23.0 / 16.0		27.0 / 19.0		29.0 / 21.0		32.0 / 23.0	
(°CDB)	TC	SHC	TC	SHC	TC	SHC	TC	SHC	TC	SHC	TC	SHC
-10.0	2.03	1.30	2.29	1.48	2.42	1.71	2.59	1.92	2.77	2.10	2.85	2.40
0.0	2.03	1.30	2.29	1.48	2.42	1.71	2.59	1.92	2.77	2.10	2.85	2.40
5.0	2.03	1.30	2.29	1.48	2.42	1.71	2.59	1.92	2.77	2.10	2.85	2.40
10.0	2.03	1.30	2.29	1.48	2.42	1.71	2.59	1.92	2.77	2.10	2.85	2.40
15.0	2.03	1.30	2.29	1.48	2.42	1.71	2.59	1.92	2.77	2.10	2.85	2.40
20.0	2.03	1.30	2.29	1.48	2.42	1.71	2.59	1.92	2.77	2.10	2.85	2.40
25.0	2.03	1.30	2.29	1.48	2.42	1.71	2.59	1.92	2.77	2.10	2.85	2.40
30.0	2.03	1.30	2.29	1.48	2.42	1.71	2.59	1.92	2.77	2.10	2.85	2.40
35.0	2.03	1.30	2.29	1.48	2.42	1.71	2.59	1.92	2.77	2.10	2.85	2.40
40.0	1.76	0.98	1.99	1.12	2.10	1.29	2.25	1.44	2.40	1.58	2.48	1.81
46.0	1.53	0.74	1.73	0.84	1.83	0.97	1.96	1.09	2.09	1.20	2.16	1.37

Model: ARXG12KSLAP

Outdoor temperature	Indoor temperature (°CDB / °CWB)											
	18.0 / 12.0		21.0 / 15.0		23.0 / 16.0		27.0 / 19.0		29.0 / 21.0		32.0 / 23.0	
(°CDB)	TC	SHC	TC	SHC	TC	SHC	TC	SHC	TC	SHC	TC	SHC
-10.0	2.28	1.46	2.58	1.66	2.72	1.92	2.91	2.15	3.11	2.36	3.21	2.70
0.0	2.28	1.46	2.58	1.66	2.72	1.92	2.91	2.15	3.11	2.36	3.21	2.70
5.0	2.28	1.46	2.58	1.66	2.72	1.92	2.91	2.15	3.11	2.36	3.21	2.70
10.0	2.28	1.46	2.58	1.66	2.72	1.92	2.91	2.15	3.11	2.36	3.21	2.70
15.0	2.28	1.46	2.58	1.66	2.72	1.92	2.91	2.15	3.11	2.36	3.21	2.70
20.0	2.28	1.46	2.58	1.66	2.72	1.92	2.91	2.15	3.11	2.36	3.21	2.70
25.0	2.28	1.46	2.58	1.66	2.72	1.92	2.91	2.15	3.11	2.36	3.21	2.70
30.0	2.28	1.46	2.58	1.66	2.72	1.92	2.91	2.15	3.11	2.36	3.21	2.70
35.0	2.28	1.46	2.58	1.66	2.72	1.92	2.91	2.15	3.11	2.36	3.21	2.70
40.0	1.98	1.10	2.24	1.25	2.36	1.44	2.53	1.62	2.70	1.78	2.78	2.03
46.0	1.72	0.83	1.95	0.95	2.05	1.09	2.20	1.23	2.35	1.34	2.42	1.54

NOTES:

- TC: Total Capacity (kW), SHC: Sensible Heat Capacity (kW)
- Values mentioned in the table are based on the following conditions:
 - Pipe length: 5 m, Height difference: 0 m [Outdoor unit—Indoor unit]

● Slim duct type

Model: ARXG07KLLAP

Outdoor temperature	Indoor temperature (°CDB / °CWB)											
	18.0 / 12.0		21.0 / 15.0		23.0 / 16.0		27.0 / 19.0		29.0 / 21.0		32.0 / 23.0	
(°CDB)	TC	SHC	TC	SHC	TC	SHC	TC	SHC	TC	SHC	TC	SHC
-10.0	1.80	1.25	2.04	1.42	2.15	1.64	2.30	1.84	2.46	2.01	2.53	2.31
0.0	1.80	1.25	2.04	1.42	2.15	1.64	2.30	1.84	2.46	2.01	2.53	2.31
5.0	1.80	1.25	2.04	1.42	2.15	1.64	2.30	1.84	2.46	2.01	2.53	2.31
10.0	1.80	1.25	2.04	1.42	2.15	1.64	2.30	1.84	2.46	2.01	2.53	2.31
15.0	1.80	1.25	2.04	1.42	2.15	1.64	2.30	1.84	2.46	2.01	2.53	2.31
20.0	1.80	1.25	2.04	1.42	2.15	1.64	2.30	1.84	2.46	2.01	2.53	2.31
25.0	1.80	1.25	2.04	1.42	2.15	1.64	2.30	1.84	2.46	2.01	2.53	2.31
30.0	1.80	1.25	2.04	1.42	2.15	1.64	2.30	1.84	2.46	2.01	2.53	2.31
35.0	1.80	1.25	2.04	1.42	2.15	1.64	2.30	1.84	2.46	2.01	2.53	2.31
40.0	1.57	0.94	1.77	1.07	1.87	1.23	2.00	1.39	2.13	1.52	2.20	1.74
46.0	1.36	0.71	1.54	0.81	1.62	0.93	1.74	1.05	1.86	1.15	1.91	1.31

Model: ARXG09KLLAP

Outdoor temperature	Indoor temperature (°CDB / °CWB)											
	18.0 / 12.0		21.0 / 15.0		23.0 / 16.0		27.0 / 19.0		29.0 / 21.0		32.0 / 23.0	
(°CDB)	TC	SHC	TC	SHC	TC	SHC	TC	SHC	TC	SHC	TC	SHC
-10.0	2.03	1.35	2.29	1.54	2.42	1.78	2.59	1.99	2.77	2.18	2.85	2.50
0.0	2.03	1.35	2.29	1.54	2.42	1.78	2.59	1.99	2.77	2.18	2.85	2.50
5.0	2.03	1.35	2.29	1.54	2.42	1.78	2.59	1.99	2.77	2.18	2.85	2.50
10.0	2.03	1.35	2.29	1.54	2.42	1.78	2.59	1.99	2.77	2.18	2.85	2.50
15.0	2.03	1.35	2.29	1.54	2.42	1.78	2.59	1.99	2.77	2.18	2.85	2.50
20.0	2.03	1.35	2.29	1.54	2.42	1.78	2.59	1.99	2.77	2.18	2.85	2.50
25.0	2.03	1.35	2.29	1.54	2.42	1.78	2.59	1.99	2.77	2.18	2.85	2.50
30.0	2.03	1.35	2.29	1.54	2.42	1.78	2.59	1.99	2.77	2.18	2.85	2.50
35.0	2.03	1.35	2.29	1.54	2.42	1.78	2.59	1.99	2.77	2.18	2.85	2.50
40.0	1.76	1.02	1.99	1.16	2.10	1.34	2.25	1.50	2.40	1.64	2.48	1.88
46.0	1.53	0.77	1.73	0.88	1.83	1.01	1.96	1.14	2.09	1.24	2.16	1.43

Model: ARXG12KLLAP

Outdoor temperature	Indoor temperature (°CDB / °CWB)											
	18.0 / 12.0		21.0 / 15.0		23.0 / 16.0		27.0 / 19.0		29.0 / 21.0		32.0 / 23.0	
(°CDB)	TC	SHC	TC	SHC	TC	SHC	TC	SHC	TC	SHC	TC	SHC
-10.0	2.28	1.54	2.58	1.75	2.72	2.02	2.91	2.27	3.11	2.48	3.21	2.84
0.0	2.28	1.54	2.58	1.75	2.72	2.02	2.91	2.27	3.11	2.48	3.21	2.84
5.0	2.28	1.54	2.58	1.75	2.72	2.02	2.91	2.27	3.11	2.48	3.21	2.84
10.0	2.28	1.54	2.58	1.75	2.72	2.02	2.91	2.27	3.11	2.48	3.21	2.84
15.0	2.28	1.54	2.58	1.75	2.72	2.02	2.91	2.27	3.11	2.48	3.21	2.84
20.0	2.28	1.54	2.58	1.75	2.72	2.02	2.91	2.27	3.11	2.48	3.21	2.84
25.0	2.28	1.54	2.58	1.75	2.72	2.02	2.91	2.27	3.11	2.48	3.21	2.84
30.0	2.28	1.54	2.58	1.75	2.72	2.02	2.91	2.27	3.11	2.48	3.21	2.84
35.0	2.28	1.54	2.58	1.75	2.72	2.02	2.91	2.27	3.11	2.48	3.21	2.84
40.0	1.98	1.16	2.24	1.32	2.36	1.52	2.53	1.71	2.70	1.87	2.78	2.14
46.0	1.72	0.88	1.95	1.00	2.05	1.15	2.20	1.29	2.35	1.42	2.42	1.62

NOTES:

- TC: Total Capacity (kW), SHC: Sensible Heat Capacity (kW)
- Values mentioned in the table are based on the following conditions:
 - Pipe length: 5 m, Height difference: 0 m (Outdoor unit—Indoor unit)

● Medium static pressure duct type

Model: ARXH12KMTAP

Outdoor temperature (°CDB)	Indoor temperature (°CDB / °CWB)											
	18.0 / 12.0		21.0 / 15.0		23.0 / 16.0		27.0 / 19.0		29.0 / 21.0		32.0 / 23.0	
	TC	SHC	TC	SHC	TC	SHC	TC	SHC	TC	SHC	TC	SHC
-10.0	2.28	1.54	2.58	1.75	2.72	2.02	2.91	2.27	3.11	2.48	3.21	2.84
0.0	2.28	1.54	2.58	1.75	2.72	2.02	2.91	2.27	3.11	2.48	3.21	2.84
5.0	2.28	1.54	2.58	1.75	2.72	2.02	2.91	2.27	3.11	2.48	3.21	2.84
10.0	2.28	1.54	2.58	1.75	2.72	2.02	2.91	2.27	3.11	2.48	3.21	2.84
15.0	2.28	1.54	2.58	1.75	2.72	2.02	2.91	2.27	3.11	2.48	3.21	2.84
20.0	2.28	1.54	2.58	1.75	2.72	2.02	2.91	2.27	3.11	2.48	3.21	2.84
25.0	2.28	1.54	2.58	1.75	2.72	2.02	2.91	2.27	3.11	2.48	3.21	2.84
30.0	2.28	1.54	2.58	1.75	2.72	2.02	2.91	2.27	3.11	2.48	3.21	2.84
35.0	2.28	1.54	2.58	1.75	2.72	2.02	2.91	2.27	3.11	2.48	3.21	2.84
40.0	1.98	1.16	2.24	1.32	2.36	1.52	2.53	1.71	2.70	1.87	2.78	2.14
46.0	1.72	0.88	1.95	1.00	2.05	1.15	2.20	1.29	2.35	1.42	2.42	1.62

NOTES:

- TC: Total Capacity (kW), SHC: Sensible Heat Capacity (kW).
- Values mentioned in the table are based on the following conditions:
 - Pipe length: 5 m, Height difference: 0 m (Outdoor unit—Indoor unit)

● Wall mounted type

Model: ASEH07KMCG, ASEH07KMCG-B

Outdoor temperature	Indoor temperature (°CDB / °CWB)											
	18.0 / 12.0		21.0 / 15.0		23.0 / 16.0		27.0 / 19.0		29.0 / 21.0		32.0 / 23.0	
(°CDB)	TC	SHC	TC	SHC	TC	SHC	TC	SHC	TC	SHC	TC	SHC
-10.0	1.80	1.01	2.04	1.16	2.15	1.33	2.30	1.50	2.46	1.64	2.53	1.87
0.0	1.80	1.01	2.04	1.16	2.15	1.33	2.30	1.50	2.46	1.64	2.53	1.87
5.0	1.80	1.01	2.04	1.16	2.15	1.33	2.30	1.50	2.46	1.64	2.53	1.87
10.0	1.80	1.01	2.04	1.16	2.15	1.33	2.30	1.50	2.46	1.64	2.53	1.87
15.0	1.80	1.01	2.04	1.16	2.15	1.33	2.30	1.50	2.46	1.64	2.53	1.87
20.0	1.80	1.01	2.04	1.16	2.15	1.33	2.30	1.50	2.46	1.64	2.53	1.87
25.0	1.80	1.01	2.04	1.16	2.15	1.33	2.30	1.50	2.46	1.64	2.53	1.87
30.0	1.80	1.01	2.04	1.16	2.15	1.33	2.30	1.50	2.46	1.64	2.53	1.87
35.0	1.80	1.01	2.04	1.16	2.15	1.33	2.30	1.50	2.46	1.64	2.53	1.87
40.0	1.57	0.76	1.77	0.87	1.87	1.00	2.00	1.13	2.13	1.23	2.20	1.41
46.0	1.36	0.58	1.54	0.66	1.62	0.76	1.74	0.85	1.86	0.93	1.91	1.07

Model: ASEH09KMCG, ASEH09KMCG-B

Outdoor temperature	Indoor temperature (°CDB / °CWB)											
	18.0 / 12.0		21.0 / 15.0		23.0 / 16.0		27.0 / 19.0		29.0 / 21.0		32.0 / 23.0	
(°CDB)	TC	SHC	TC	SHC	TC	SHC	TC	SHC	TC	SHC	TC	SHC
-10.0	2.03	1.14	2.29	1.30	2.42	1.50	2.59	1.68	2.77	1.84	2.85	2.11
0.0	2.03	1.14	2.29	1.30	2.42	1.50	2.59	1.68	2.77	1.84	2.85	2.11
5.0	2.03	1.14	2.29	1.30	2.42	1.50	2.59	1.68	2.77	1.84	2.85	2.11
10.0	2.03	1.14	2.29	1.30	2.42	1.50	2.59	1.68	2.77	1.84	2.85	2.11
15.0	2.03	1.14	2.29	1.30	2.42	1.50	2.59	1.68	2.77	1.84	2.85	2.11
20.0	2.03	1.14	2.29	1.30	2.42	1.50	2.59	1.68	2.77	1.84	2.85	2.11
25.0	2.03	1.14	2.29	1.30	2.42	1.50	2.59	1.68	2.77	1.84	2.85	2.11
30.0	2.03	1.14	2.29	1.30	2.42	1.50	2.59	1.68	2.77	1.84	2.85	2.11
35.0	2.03	1.14	2.29	1.30	2.42	1.50	2.59	1.68	2.77	1.84	2.85	2.11
40.0	1.76	0.86	1.99	0.98	2.10	1.13	2.25	1.27	2.40	1.39	2.48	1.59
46.0	1.53	0.65	1.73	0.74	1.83	0.85	1.96	0.96	2.09	1.05	2.16	1.20

Model: ASEH12KMCG, ASEH12KMCG-B

Outdoor temperature	Indoor temperature (°CDB / °CWB)											
	18.0 / 12.0		21.0 / 15.0		23.0 / 16.0		27.0 / 19.0		29.0 / 21.0		32.0 / 23.0	
(°CDB)	TC	SHC	TC	SHC	TC	SHC	TC	SHC	TC	SHC	TC	SHC
-10.0	2.28	1.28	2.58	1.46	2.72	1.68	2.91	1.89	3.11	2.07	3.21	2.37
0.0	2.28	1.28	2.58	1.46	2.72	1.68	2.91	1.89	3.11	2.07	3.21	2.37
5.0	2.28	1.28	2.58	1.46	2.72	1.68	2.91	1.89	3.11	2.07	3.21	2.37
10.0	2.28	1.28	2.58	1.46	2.72	1.68	2.91	1.89	3.11	2.07	3.21	2.37
15.0	2.28	1.28	2.58	1.46	2.72	1.68	2.91	1.89	3.11	2.07	3.21	2.37
20.0	2.28	1.28	2.58	1.46	2.72	1.68	2.91	1.89	3.11	2.07	3.21	2.37
25.0	2.28	1.28	2.58	1.46	2.72	1.68	2.91	1.89	3.11	2.07	3.21	2.37
30.0	2.28	1.28	2.58	1.46	2.72	1.68	2.91	1.89	3.11	2.07	3.21	2.37
35.0	2.28	1.28	2.58	1.46	2.72	1.68	2.91	1.89	3.11	2.07	3.21	2.37
40.0	1.98	0.97	2.24	1.10	2.36	1.27	2.53	1.43	2.70	1.56	2.78	1.79
46.0	1.72	0.73	1.95	0.83	2.05	0.96	2.20	1.08	2.35	1.18	2.42	1.35

Models: ASEG07KETF and ASEG07KETF-B

Outdoor temperature	Indoor temperature (°CDB / °CWB)											
	18.0 / 12.0		21.0 / 15.0		23.0 / 16.0		27.0 / 19.0		29.0 / 21.0		32.0 / 23.0	
(°CDB)	TC	SHC	TC	SHC	TC	SHC	TC	SHC	TC	SHC	TC	SHC
-10.0	1.80	1.01	2.04	1.16	2.15	1.33	2.30	1.50	2.46	1.64	2.53	1.87
0.0	1.80	1.01	2.04	1.16	2.15	1.33	2.30	1.50	2.46	1.64	2.53	1.87
5.0	1.80	1.01	2.04	1.16	2.15	1.33	2.30	1.50	2.46	1.64	2.53	1.87
10.0	1.80	1.01	2.04	1.16	2.15	1.33	2.30	1.50	2.46	1.64	2.53	1.87
15.0	1.80	1.01	2.04	1.16	2.15	1.33	2.30	1.50	2.46	1.64	2.53	1.87
20.0	1.80	1.01	2.04	1.16	2.15	1.33	2.30	1.50	2.46	1.64	2.53	1.87
25.0	1.80	1.01	2.04	1.16	2.15	1.33	2.30	1.50	2.46	1.64	2.53	1.87
30.0	1.80	1.01	2.04	1.16	2.15	1.33	2.30	1.50	2.46	1.64	2.53	1.87
35.0	1.80	1.01	2.04	1.16	2.15	1.33	2.30	1.50	2.46	1.64	2.53	1.87
40.0	1.57	0.76	1.77	0.87	1.87	1.00	2.00	1.13	2.13	1.23	2.20	1.41
46.0	1.36	0.58	1.54	0.66	1.62	0.76	1.74	0.85	1.86	0.93	1.91	1.07

Models: ASEG09KETF and ASEG09KETF-B

Outdoor temperature	Indoor temperature (°CDB / °CWB)											
	18.0 / 12.0		21.0 / 15.0		23.0 / 16.0		27.0 / 19.0		29.0 / 21.0		32.0 / 23.0	
(°CDB)	TC	SHC	TC	SHC	TC	SHC	TC	SHC	TC	SHC	TC	SHC
-10.0	2.03	1.14	2.29	1.30	2.42	1.50	2.59	1.68	2.77	1.84	2.85	2.11
0.0	2.03	1.14	2.29	1.30	2.42	1.50	2.59	1.68	2.77	1.84	2.85	2.11
5.0	2.03	1.14	2.29	1.30	2.42	1.50	2.59	1.68	2.77	1.84	2.85	2.11
10.0	2.03	1.14	2.29	1.30	2.42	1.50	2.59	1.68	2.77	1.84	2.85	2.11
15.0	2.03	1.14	2.29	1.30	2.42	1.50	2.59	1.68	2.77	1.84	2.85	2.11
20.0	2.03	1.14	2.29	1.30	2.42	1.50	2.59	1.68	2.77	1.84	2.85	2.11
25.0	2.03	1.14	2.29	1.30	2.42	1.50	2.59	1.68	2.77	1.84	2.85	2.11
30.0	2.03	1.14	2.29	1.30	2.42	1.50	2.59	1.68	2.77	1.84	2.85	2.11
35.0	2.03	1.14	2.29	1.30	2.42	1.50	2.59	1.68	2.77	1.84	2.85	2.11
40.0	1.76	0.86	1.99	0.98	2.10	1.13	2.25	1.27	2.40	1.39	2.48	1.59
46.0	1.53	0.65	1.73	0.74	1.83	0.85	1.96	0.96	2.09	1.05	2.16	1.20

Models: ASEG12KETF and ASEG12KETF-B

Outdoor temperature	Indoor temperature (°CDB / °CWB)											
	18.0 / 12.0		21.0 / 15.0		23.0 / 16.0		27.0 / 19.0		29.0 / 21.0		32.0 / 23.0	
(°CDB)	TC	SHC	TC	SHC	TC	SHC	TC	SHC	TC	SHC	TC	SHC
-10.0	2.28	1.28	2.58	1.46	2.72	1.68	2.91	1.89	3.11	2.07	3.21	2.37
0.0	2.28	1.28	2.58	1.46	2.72	1.68	2.91	1.89	3.11	2.07	3.21	2.37
5.0	2.28	1.28	2.58	1.46	2.72	1.68	2.91	1.89	3.11	2.07	3.21	2.37
10.0	2.28	1.28	2.58	1.46	2.72	1.68	2.91	1.89	3.11	2.07	3.21	2.37
15.0	2.28	1.28	2.58	1.46	2.72	1.68	2.91	1.89	3.11	2.07	3.21	2.37
20.0	2.28	1.28	2.58	1.46	2.72	1.68	2.91	1.89	3.11	2.07	3.21	2.37
25.0	2.28	1.28	2.58	1.46	2.72	1.68	2.91	1.89	3.11	2.07	3.21	2.37
30.0	2.28	1.28	2.58	1.46	2.72	1.68	2.91	1.89	3.11	2.07	3.21	2.37
35.0	2.28	1.28	2.58	1.46	2.72	1.68	2.91	1.89	3.11	2.07	3.21	2.37
40.0	1.98	0.97	2.24	1.10	2.36	1.27	2.53	1.43	2.70	1.56	2.78	1.79
46.0	1.72	0.73	1.95	0.83	2.05	0.96	2.20	1.08	2.35	1.18	2.42	1.35

Model: ASEH07KGTG

Outdoor temperature	Indoor temperature (°CDB / °CWB)											
	18.0 / 12.0		21.0 / 15.0		23.0 / 16.0		27.0 / 19.0		29.0 / 21.0		32.0 / 23.0	
(°CDB)	TC	SHC	TC	SHC	TC	SHC	TC	SHC	TC	SHC	TC	SHC
-10.0	1.80	1.01	2.04	1.16	2.15	1.33	2.30	1.50	2.46	1.64	2.53	1.87
0.0	1.80	1.01	2.04	1.16	2.15	1.33	2.30	1.50	2.46	1.64	2.53	1.87
5.0	1.80	1.01	2.04	1.16	2.15	1.33	2.30	1.50	2.46	1.64	2.53	1.87
10.0	1.80	1.01	2.04	1.16	2.15	1.33	2.30	1.50	2.46	1.64	2.53	1.87
15.0	1.80	1.01	2.04	1.16	2.15	1.33	2.30	1.50	2.46	1.64	2.53	1.87
20.0	1.80	1.01	2.04	1.16	2.15	1.33	2.30	1.50	2.46	1.64	2.53	1.87
25.0	1.80	1.01	2.04	1.16	2.15	1.33	2.30	1.50	2.46	1.64	2.53	1.87
30.0	1.80	1.01	2.04	1.16	2.15	1.33	2.30	1.50	2.46	1.64	2.53	1.87
35.0	1.80	1.01	2.04	1.16	2.15	1.33	2.30	1.50	2.46	1.64	2.53	1.87
40.0	1.57	0.76	1.77	0.87	1.87	1.00	2.00	1.13	2.13	1.23	2.20	1.41
46.0	1.36	0.58	1.54	0.66	1.62	0.76	1.74	0.85	1.86	0.93	1.91	1.07

Model: ASEH09KGTG

Outdoor temperature	Indoor temperature (°CDB / °CWB)											
	18.0 / 12.0		21.0 / 15.0		23.0 / 16.0		27.0 / 19.0		29.0 / 21.0		32.0 / 23.0	
(°CDB)	TC	SHC	TC	SHC	TC	SHC	TC	SHC	TC	SHC	TC	SHC
-10.0	2.03	1.14	2.29	1.30	2.42	1.50	2.59	1.68	2.77	1.84	2.85	2.11
0.0	2.03	1.14	2.29	1.30	2.42	1.50	2.59	1.68	2.77	1.84	2.85	2.11
5.0	2.03	1.14	2.29	1.30	2.42	1.50	2.59	1.68	2.77	1.84	2.85	2.11
10.0	2.03	1.14	2.29	1.30	2.42	1.50	2.59	1.68	2.77	1.84	2.85	2.11
15.0	2.03	1.14	2.29	1.30	2.42	1.50	2.59	1.68	2.77	1.84	2.85	2.11
20.0	2.03	1.14	2.29	1.30	2.42	1.50	2.59	1.68	2.77	1.84	2.85	2.11
25.0	2.03	1.14	2.29	1.30	2.42	1.50	2.59	1.68	2.77	1.84	2.85	2.11
30.0	2.03	1.14	2.29	1.30	2.42	1.50	2.59	1.68	2.77	1.84	2.85	2.11
35.0	2.03	1.14	2.29	1.30	2.42	1.50	2.59	1.68	2.77	1.84	2.85	2.11
40.0	1.76	0.86	1.99	0.98	2.10	1.13	2.25	1.27	2.40	1.39	2.48	1.59
46.0	1.53	0.65	1.73	0.74	1.83	0.85	1.96	0.96	2.09	1.05	2.16	1.20

Model: ASEH12KGTG

Outdoor temperature	Indoor temperature (°CDB / °CWB)											
	18.0 / 12.0		21.0 / 15.0		23.0 / 16.0		27.0 / 19.0		29.0 / 21.0		32.0 / 23.0	
(°CDB)	TC	SHC	TC	SHC	TC	SHC	TC	SHC	TC	SHC	TC	SHC
-10.0	2.28	1.28	2.58	1.46	2.72	1.68	2.91	1.89	3.11	2.07	3.21	2.37
0.0	2.28	1.28	2.58	1.46	2.72	1.68	2.91	1.89	3.11	2.07	3.21	2.37
5.0	2.28	1.28	2.58	1.46	2.72	1.68	2.91	1.89	3.11	2.07	3.21	2.37
10.0	2.28	1.28	2.58	1.46	2.72	1.68	2.91	1.89	3.11	2.07	3.21	2.37
15.0	2.28	1.28	2.58	1.46	2.72	1.68	2.91	1.89	3.11	2.07	3.21	2.37
20.0	2.28	1.28	2.58	1.46	2.72	1.68	2.91	1.89	3.11	2.07	3.21	2.37
25.0	2.28	1.28	2.58	1.46	2.72	1.68	2.91	1.89	3.11	2.07	3.21	2.37
30.0	2.28	1.28	2.58	1.46	2.72	1.68	2.91	1.89	3.11	2.07	3.21	2.37
35.0	2.28	1.28	2.58	1.46	2.72	1.68	2.91	1.89	3.11	2.07	3.21	2.37
40.0	1.98	0.97	2.24	1.10	2.36	1.27	2.53	1.43	2.70	1.56	2.78	1.79
46.0	1.72	0.73	1.95	0.83	2.05	0.96	2.20	1.08	2.35	1.18	2.42	1.35

Model: ASEH05KNCA

Outdoor temperature	Indoor temperature (°CDB / °CWB)											
	18.0 / 12.0		21.0 / 15.0		23.0 / 16.0		27.0 / 19.0		29.0 / 21.0		32.0 / 23.0	
(°CDB)	TC	SHC	TC	SHC	TC	SHC	TC	SHC	TC	SHC	TC	SHC
-10.0	1.41	0.79	1.59	0.90	1.68	1.04	1.80	1.17	1.92	1.28	1.98	1.47
-5.0	1.41	0.79	1.59	0.90	1.68	1.04	1.80	1.17	1.92	1.28	1.98	1.47
0.0	1.41	0.79	1.59	0.90	1.68	1.04	1.80	1.17	1.92	1.28	1.98	1.47
5.0	1.41	0.79	1.59	0.90	1.68	1.04	1.80	1.17	1.92	1.28	1.98	1.47
10.0	1.41	0.79	1.59	0.90	1.68	1.04	1.80	1.17	1.92	1.28	1.98	1.47
15.0	1.41	0.79	1.59	0.90	1.68	1.04	1.80	1.17	1.92	1.28	1.98	1.47
20.0	1.41	0.79	1.59	0.90	1.68	1.04	1.80	1.17	1.92	1.28	1.98	1.47
25.0	1.41	0.79	1.59	0.90	1.68	1.04	1.80	1.17	1.92	1.28	1.98	1.47
30.0	1.41	0.79	1.59	0.90	1.68	1.04	1.80	1.17	1.92	1.28	1.98	1.47
35.0	1.41	0.79	1.59	0.90	1.68	1.04	1.80	1.17	1.92	1.28	1.98	1.47
40.0	1.23	0.60	1.38	0.68	1.46	0.78	1.56	0.88	1.67	0.96	1.72	1.11
46.0	1.07	0.45	1.20	0.52	1.27	0.59	1.36	0.67	1.45	0.73	1.50	0.84

Model: ASEH07KNCA

Outdoor temperature	Indoor temperature (°CDB / °CWB)											
	18.0 / 12.0		21.0 / 15.0		23.0 / 16.0		27.0 / 19.0		29.0 / 21.0		32.0 / 23.0	
(°CDB)	TC	SHC	TC	SHC	TC	SHC	TC	SHC	TC	SHC	TC	SHC
-10.0	1.80	1.01	2.04	1.16	2.15	1.33	2.30	1.50	2.46	1.64	2.53	1.87
-5.0	1.80	1.01	2.04	1.16	2.15	1.33	2.30	1.50	2.46	1.64	2.53	1.87
0.0	1.80	1.01	2.04	1.16	2.15	1.33	2.30	1.50	2.46	1.64	2.53	1.87
5.0	1.80	1.01	2.04	1.16	2.15	1.33	2.30	1.50	2.46	1.64	2.53	1.87
10.0	1.80	1.01	2.04	1.16	2.15	1.33	2.30	1.50	2.46	1.64	2.53	1.87
15.0	1.80	1.01	2.04	1.16	2.15	1.33	2.30	1.50	2.46	1.64	2.53	1.87
20.0	1.80	1.01	2.04	1.16	2.15	1.33	2.30	1.50	2.46	1.64	2.53	1.87
25.0	1.80	1.01	2.04	1.16	2.15	1.33	2.30	1.50	2.46	1.64	2.53	1.87
30.0	1.80	1.01	2.04	1.16	2.15	1.33	2.30	1.50	2.46	1.64	2.53	1.87
35.0	1.80	1.01	2.04	1.16	2.15	1.33	2.30	1.50	2.46	1.64	2.53	1.87
40.0	1.57	0.76	1.77	0.87	1.87	1.00	2.00	1.13	2.13	1.23	2.20	1.41
46.0	1.36	0.58	1.54	0.66	1.62	0.76	1.74	0.85	1.86	0.93	1.91	1.07

Model: ASEH09KNCA

Outdoor temperature	Indoor temperature (°CDB / °CWB)											
	18.0 / 12.0		21.0 / 15.0		23.0 / 16.0		27.0 / 19.0		29.0 / 21.0		32.0 / 23.0	
(°CDB)	TC	SHC	TC	SHC	TC	SHC	TC	SHC	TC	SHC	TC	SHC
-10.0	2.03	1.14	2.29	1.30	2.42	1.50	2.59	1.68	2.77	1.84	2.85	2.11
-5.0	2.03	1.14	2.29	1.30	2.42	1.50	2.59	1.68	2.77	1.84	2.85	2.11
0.0	2.03	1.14	2.29	1.30	2.42	1.50	2.59	1.68	2.77	1.84	2.85	2.11
5.0	2.03	1.14	2.29	1.30	2.42	1.50	2.59	1.68	2.77	1.84	2.85	2.11
10.0	2.03	1.14	2.29	1.30	2.42	1.50	2.59	1.68	2.77	1.84	2.85	2.11
15.0	2.03	1.14	2.29	1.30	2.42	1.50	2.59	1.68	2.77	1.84	2.85	2.11
20.0	2.03	1.14	2.29	1.30	2.42	1.50	2.59	1.68	2.77	1.84	2.85	2.11
25.0	2.03	1.14	2.29	1.30	2.42	1.50	2.59	1.68	2.77	1.84	2.85	2.11
30.0	2.03	1.14	2.29	1.30	2.42	1.50	2.59	1.68	2.77	1.84	2.85	2.11
35.0	2.03	1.14	2.29	1.30	2.42	1.50	2.59	1.68	2.77	1.84	2.85	2.11
40.0	1.76	0.86	1.99	0.98	2.10	1.13	2.25	1.27	2.40	1.39	2.48	1.59
46.0	1.53	0.65	1.73	0.74	1.83	0.85	1.96	0.96	2.09	1.05	2.16	1.20

Model: ASEH12KNCA

Outdoor temperature	Indoor temperature (°CDB / °CWB)											
	18.0 / 12.0		21.0 / 15.0		23.0 / 16.0		27.0 / 19.0		29.0 / 21.0		32.0 / 23.0	
(°CDB)	TC	SHC	TC	SHC	TC	SHC	TC	SHC	TC	SHC	TC	SHC
-10.0	2.28	1.28	2.58	1.46	2.72	1.68	2.91	1.89	3.11	2.07	3.21	2.37
-5.0	2.28	1.28	2.58	1.46	2.72	1.68	2.91	1.89	3.11	2.07	3.21	2.37
0.0	2.28	1.28	2.58	1.46	2.72	1.68	2.91	1.89	3.11	2.07	3.21	2.37
5.0	2.28	1.28	2.58	1.46	2.72	1.68	2.91	1.89	3.11	2.07	3.21	2.37
10.0	2.28	1.28	2.58	1.46	2.72	1.68	2.91	1.89	3.11	2.07	3.21	2.37
15.0	2.28	1.28	2.58	1.46	2.72	1.68	2.91	1.89	3.11	2.07	3.21	2.37
20.0	2.28	1.28	2.58	1.46	2.72	1.68	2.91	1.89	3.11	2.07	3.21	2.37
25.0	2.28	1.28	2.58	1.46	2.72	1.68	2.91	1.89	3.11	2.07	3.21	2.37
30.0	2.28	1.28	2.58	1.46	2.72	1.68	2.91	1.89	3.11	2.07	3.21	2.37
35.0	2.28	1.28	2.58	1.46	2.72	1.68	2.91	1.89	3.11	2.07	3.21	2.37
40.0	1.98	0.97	2.24	1.10	2.36	1.27	2.53	1.43	2.70	1.56	2.78	1.79
46.0	1.72	0.73	1.95	0.83	2.05	0.96	2.20	1.08	2.35	1.18	2.42	1.35

NOTES:

- TC: Total Capacity (kW), SHC: Sensible Heat Capacity (kW)
- Values mentioned in the table are based on the following conditions:
 - Pipe length: 5 m, Height difference: 0 m (Outdoor unit—Indoor unit)

● Floor type

Model: AGEG09KVCA

Outdoor temperature	Indoor temperature (°CDB / °CWB)											
	18.0 / 12.0		21.0 / 15.0		23.0 / 16.0		27.0 / 19.0		29.0 / 21.0		32.0 / 23.0	
(°CDB)	TC	SHC	TC	SHC	TC	SHC	TC	SHC	TC	SHC	TC	SHC
-10.0	2.03	1.39	2.29	1.58	2.42	1.82	2.59	2.05	2.77	2.24	2.85	2.56
-5.0	2.03	1.39	2.29	1.58	2.42	1.82	2.59	2.05	2.77	2.24	2.85	2.56
0.0	2.03	1.39	2.29	1.58	2.42	1.82	2.59	2.05	2.77	2.24	2.85	2.56
5.0	2.03	1.39	2.29	1.58	2.42	1.82	2.59	2.05	2.77	2.24	2.85	2.56
10.0	2.03	1.39	2.29	1.58	2.42	1.82	2.59	2.05	2.77	2.24	2.85	2.56
15.0	2.03	1.39	2.29	1.58	2.42	1.82	2.59	2.05	2.77	2.24	2.85	2.56
20.0	2.03	1.39	2.29	1.58	2.42	1.82	2.59	2.05	2.77	2.24	2.85	2.56
25.0	2.03	1.39	2.29	1.58	2.42	1.82	2.59	2.05	2.77	2.24	2.85	2.56
30.0	2.03	1.39	2.29	1.58	2.42	1.82	2.59	2.05	2.77	2.24	2.85	2.56
35.0	2.03	1.39	2.29	1.58	2.42	1.82	2.59	2.05	2.77	2.24	2.85	2.56
40.0	1.76	1.05	1.99	1.19	2.10	1.37	2.25	1.54	2.40	1.69	2.48	1.93
46.0	1.53	0.79	1.73	0.90	1.83	1.04	1.96	1.17	2.09	1.28	2.16	1.46

Model: AGEG12KVCA

Outdoor temperature	Indoor temperature (°CDB / °CWB)											
	18.0 / 12.0		21.0 / 15.0		23.0 / 16.0		27.0 / 19.0		29.0 / 21.0		32.0 / 23.0	
(°CDB)	TC	SHC	TC	SHC	TC	SHC	TC	SHC	TC	SHC	TC	SHC
-10.0	2.28	1.46	2.58	1.66	2.72	1.92	2.91	2.15	3.11	2.36	3.21	2.70
-5.0	2.28	1.46	2.58	1.66	2.72	1.92	2.91	2.15	3.11	2.36	3.21	2.70
0.0	2.28	1.46	2.58	1.66	2.72	1.92	2.91	2.15	3.11	2.36	3.21	2.70
5.0	2.28	1.46	2.58	1.66	2.72	1.92	2.91	2.15	3.11	2.36	3.21	2.70
10.0	2.28	1.46	2.58	1.66	2.72	1.92	2.91	2.15	3.11	2.36	3.21	2.70
15.0	2.28	1.46	2.58	1.66	2.72	1.92	2.91	2.15	3.11	2.36	3.21	2.70
20.0	2.28	1.46	2.58	1.66	2.72	1.92	2.91	2.15	3.11	2.36	3.21	2.70
25.0	2.28	1.46	2.58	1.66	2.72	1.92	2.91	2.15	3.11	2.36	3.21	2.70
30.0	2.28	1.46	2.58	1.66	2.72	1.92	2.91	2.15	3.11	2.36	3.21	2.70
35.0	2.28	1.46	2.58	1.66	2.72	1.92	2.91	2.15	3.11	2.36	3.21	2.70
40.0	1.98	1.10	2.24	1.25	2.36	1.44	2.53	1.62	2.70	1.78	2.78	2.03
46.0	1.72	0.83	1.95	0.95	2.05	1.09	2.20	1.23	2.35	1.34	2.42	1.54

NOTES:

- TC: Total Capacity (kW), SHC: Sensible Heat Capacity (kW)
- Values mentioned in the table are based on the following conditions:
 - Pipe length: 5 m, Height difference: 0 m (Outdoor unit—Indoor unit)

Model: AOEG18KBCA2

OUTDOOR UNIT

OUTDOOR UNIT

Indoor unit connect- ing capacity	Outdoor temperature	Indoor temperature											
		18.0 °CDB		21.0 °CDB		23.0 °CDB		27.0 °CDB		29.0 °CDB		32.0 °CDB	
		12.0 °CWB		15.0 °CWB		16.0 °CWB		19.0 °CWB		21.0 °CWB		23.0 °CWB	
kBtu/h	°CDB	TC	IP	TC	IP	TC	IP	TC	IP	TC	IP	TC	IP
26	-10.0	4.50	0.80	5.10	0.81	5.40	0.82	5.80	0.83	6.20	0.84	6.40	0.84
	0.0	4.50	1.04	5.10	1.05	5.40	1.06	5.80	1.07	6.20	1.09	6.40	1.09
	5.0	4.50	0.88	5.10	0.90	5.40	0.90	5.80	0.91	6.20	0.92	6.40	0.93
	10.0	4.50	0.48	5.10	0.49	5.40	0.50	5.80	0.50	6.20	0.51	6.40	0.51
	15.0	4.50	0.64	5.10	0.65	5.40	0.66	5.80	0.67	6.20	0.67	6.40	0.68
	20.0	4.50	0.85	5.10	0.86	5.40	0.87	5.80	0.88	6.20	0.89	6.40	0.89
	25.0	4.50	1.05	5.10	1.07	5.40	1.08	5.80	1.09	6.20	1.10	6.40	1.11
	30.0	4.50	1.22	5.10	1.24	5.40	1.25	5.80	1.27	6.20	1.28	6.40	1.29
	35.0	4.50	1.57	5.10	1.60	5.40	1.61	5.80	1.63	6.20	1.65	6.40	1.66
	40.0	3.60	1.28	4.00	1.30	4.30	1.31	4.60	1.32	4.90	1.34	5.00	1.35
46.0	2.60	0.99	2.90	1.00	3.10	1.01	3.30	1.02	3.60	1.03	3.70	1.04	
24	-10.0	4.50	0.80	5.10	0.81	5.40	0.82	5.80	0.83	6.20	0.84	6.40	0.84
	0.0	4.50	1.04	5.10	1.05	5.40	1.06	5.80	1.07	6.20	1.09	6.40	1.09
	5.0	4.50	0.88	5.10	0.90	5.40	0.90	5.80	0.91	6.20	0.92	6.40	0.93
	10.0	4.50	0.48	5.10	0.49	5.40	0.50	5.80	0.50	6.20	0.51	6.40	0.51
	15.0	4.50	0.64	5.10	0.65	5.40	0.66	5.80	0.67	6.20	0.67	6.40	0.68
	20.0	4.50	0.85	5.10	0.86	5.40	0.87	5.80	0.88	6.20	0.89	6.40	0.89
	25.0	4.50	1.05	5.10	1.07	5.40	1.08	5.80	1.09	6.20	1.10	6.40	1.11
	30.0	4.50	1.22	5.10	1.24	5.40	1.25	5.80	1.27	6.20	1.28	6.40	1.29
	35.0	4.50	1.57	5.10	1.60	5.40	1.61	5.80	1.63	6.20	1.65	6.40	1.66
	40.0	3.60	1.28	4.00	1.30	4.30	1.31	4.60	1.32	4.90	1.34	5.00	1.35
46.0	2.60	0.99	2.90	1.00	3.10	1.01	3.30	1.02	3.60	1.03	3.70	1.04	
23	-10.0	4.50	0.80	5.10	0.81	5.40	0.82	5.80	0.83	6.20	0.84	6.40	0.84
	0.0	4.50	1.04	5.10	1.05	5.40	1.06	5.80	1.07	6.20	1.09	6.40	1.09
	5.0	4.50	0.88	5.10	0.90	5.40	0.90	5.80	0.91	6.20	0.92	6.40	0.93
	10.0	4.50	0.48	5.10	0.49	5.40	0.50	5.80	0.50	6.20	0.51	6.40	0.51
	15.0	4.50	0.64	5.10	0.65	5.40	0.66	5.80	0.67	6.20	0.67	6.40	0.68
	20.0	4.50	0.85	5.10	0.86	5.40	0.87	5.80	0.88	6.20	0.89	6.40	0.89
	25.0	4.50	1.05	5.10	1.07	5.40	1.08	5.80	1.09	6.20	1.10	6.40	1.11
	30.0	4.50	1.22	5.10	1.24	5.40	1.25	5.80	1.27	6.20	1.28	6.40	1.29
	35.0	4.50	1.57	5.10	1.60	5.40	1.61	5.80	1.63	6.20	1.65	6.40	1.66
	40.0	3.60	1.28	4.00	1.30	4.30	1.31	4.60	1.32	4.90	1.34	5.00	1.35
46.0	2.60	0.99	2.90	1.00	3.10	1.01	3.30	1.02	3.60	1.03	3.70	1.04	
21	-10.0	4.50	0.80	5.10	0.81	5.40	0.82	5.80	0.83	6.20	0.84	6.40	0.84
	0.0	4.50	1.04	5.10	1.05	5.40	1.06	5.80	1.07	6.20	1.09	6.40	1.09
	5.0	4.50	0.88	5.10	0.90	5.40	0.90	5.80	0.91	6.20	0.92	6.40	0.93
	10.0	4.50	0.48	5.10	0.49	5.40	0.50	5.80	0.50	6.20	0.51	6.40	0.51
	15.0	4.50	0.64	5.10	0.65	5.40	0.66	5.80	0.67	6.20	0.67	6.40	0.68
	20.0	4.50	0.85	5.10	0.86	5.40	0.87	5.80	0.88	6.20	0.89	6.40	0.89
	25.0	4.50	1.05	5.10	1.07	5.40	1.08	5.80	1.09	6.20	1.10	6.40	1.11
	30.0	4.50	1.22	5.10	1.24	5.40	1.25	5.80	1.27	6.20	1.28	6.40	1.29
	35.0	4.50	1.57	5.10	1.60	5.40	1.61	5.80	1.63	6.20	1.65	6.40	1.66
	40.0	3.60	1.28	4.00	1.30	4.30	1.31	4.60	1.32	4.90	1.34	5.00	1.35
46.0	2.60	0.99	2.90	1.00	3.10	1.01	3.30	1.02	3.60	1.03	3.70	1.04	
19	-10.0	4.50	0.80	5.10	0.81	5.40	0.82	5.80	0.83	6.20	0.84	6.40	0.84
	0.0	4.50	1.04	5.10	1.05	5.40	1.06	5.80	1.07	6.20	1.09	6.40	1.09
	5.0	4.50	0.88	5.10	0.90	5.40	0.90	5.80	0.91	6.20	0.92	6.40	0.93
	10.0	4.50	0.48	5.10	0.49	5.40	0.50	5.80	0.50	6.20	0.51	6.40	0.51
	15.0	4.50	0.64	5.10	0.65	5.40	0.66	5.80	0.67	6.20	0.67	6.40	0.68
	20.0	4.50	0.85	5.10	0.86	5.40	0.87	5.80	0.88	6.20	0.89	6.40	0.89
	25.0	4.50	1.05	5.10	1.07	5.40	1.08	5.80	1.09	6.20	1.10	6.40	1.11
	30.0	4.50	1.22	5.10	1.24	5.40	1.25	5.80	1.27	6.20	1.28	6.40	1.29
	35.0	4.50	1.57	5.10	1.60	5.40	1.61	5.80	1.63	6.20	1.65	6.40	1.66
	40.0	3.60	1.28	4.00	1.30	4.30	1.31	4.60	1.32	4.90	1.34	5.00	1.35
46.0	2.60	0.99	2.90	1.00	3.10	1.01	3.30	1.02	3.60	1.03	3.70	1.04	
18	-10.0	4.50	0.80	5.10	0.81	5.40	0.82	5.80	0.83	6.20	0.84	6.40	0.84
	0.0	4.50	1.04	5.10	1.05	5.40	1.06	5.80	1.07	6.20	1.09	6.40	1.09
	5.0	4.50	0.88	5.10	0.90	5.40	0.90	5.80	0.91	6.20	0.92	6.40	0.93
	10.0	4.50	0.48	5.10	0.49	5.40	0.50	5.80	0.50	6.20	0.51	6.40	0.51
	15.0	4.50	0.64	5.10	0.65	5.40	0.66	5.80	0.67	6.20	0.67	6.40	0.68
	20.0	4.50	0.85	5.10	0.86	5.40	0.87	5.80	0.88	6.20	0.89	6.40	0.89
	25.0	4.50	1.05	5.10	1.07	5.40	1.08	5.80	1.09	6.20	1.10	6.40	1.11
	30.0	4.50	1.22	5.10	1.24	5.40	1.25	5.80	1.27	6.20	1.28	6.40	1.29
	35.0	4.50	1.57	5.10	1.60	5.40	1.61	5.80	1.63	6.20	1.65	6.40	1.66
	40.0	3.60	1.28	4.00	1.30	4.30	1.31	4.60	1.32	4.90	1.34	5.00	1.35
46.0	2.60	0.99	2.90	1.00	3.10	1.01	3.30	1.02	3.60	1.03	3.70	1.04	
17	-10.0	4.47	0.54	5.05	0.55	5.32	0.56	5.70	0.56	6.09	0.57	6.28	0.57
	0.0	4.47	1.01	5.05	1.02	5.32	1.03	5.70	1.04	6.09	1.06	6.28	1.06
	5.0	4.47	0.86	5.05	0.87	5.32	0.88	5.70	0.89	6.09	0.90	6.28	0.90
	10.0	4.47	0.47	5.05	0.48	5.32	0.48	5.70	0.49	6.09	0.49	6.28	0.50
	15.0	4.47	0.62	5.05	0.63	5.32	0.64	5.70	0.65	6.09	0.65	6.28	0.66
	20.0	4.47	0.82	5.05	0.84	5.32	0.84	5.70	0.85	6.09	0.86	6.28	0.87
	25.0	4.47	1.02	5.05	1.04	5.32	1.05	5.70	1.06	6.09	1.07	6.28	1.08
	30.0	4.47	1.19	5.05	1.21	5.32	1.22	5.70	1.23	6.09	1.25	6.28	1.25
	35.0	4.47	1.52	5.05	1.55	5.32	1.56	5.70	1.58	6.09	1.60	6.28	1.61
	40.0	3.52	1.24	3.97	1.26	4.19	1.27	4.49	1.29	4.80	1.30	4.94	1.31
46.0	3.52	0.96	3.97	0.97	4.19	0.98	4.49	0.99	4.80	1.00	4.94	1.01	

OUTDOOR UNIT

OUTDOOR UNIT

Indoor unit connect- ing capacity	Outdoor temperature	Indoor temperature											
		18.0 °CDB		21.0 °CDB		23.0 °CDB		27.0 °CDB		29.0 °CDB		32.0 °CDB	
		12.0 °CWB		15.0 °CWB		16.0 °CWB		19.0 °CWB		21.0 °CWB		23.0 °CWB	
kBtu/h	°CDB	TC	IP	TC	IP	TC	IP	TC	IP	TC	IP	TC	IP
16	-10.0	4.50	0.78	5.10	0.79	5.30	0.80	5.70	0.80	6.10	0.81	6.30	0.82
	0.0	4.50	1.01	5.10	1.02	5.30	1.03	5.70	1.04	6.10	1.06	6.30	1.06
	5.0	4.50	0.86	5.10	0.87	5.30	0.88	5.70	0.89	6.10	0.90	6.30	0.90
	10.0	4.50	0.47	5.10	0.48	5.30	0.48	5.70	0.49	6.10	0.49	6.30	0.50
	15.0	4.50	0.62	5.10	0.63	5.30	0.64	5.70	0.65	6.10	0.65	6.30	0.66
	20.0	4.50	0.82	5.10	0.84	5.30	0.84	5.70	0.85	6.10	0.86	6.30	0.87
	25.0	4.50	1.02	5.10	1.04	5.30	1.05	5.70	1.06	6.10	1.07	6.30	1.08
	30.0	4.50	1.19	5.10	1.21	5.30	1.22	5.70	1.23	6.10	1.25	6.30	1.25
	35.0	4.50	1.52	5.10	1.55	5.30	1.56	5.70	1.58	6.10	1.60	6.30	1.61
	40.0	3.50	1.24	4.00	1.26	4.20	1.27	4.50	1.29	4.80	1.30	4.90	1.31
14	-10.0	3.90	0.63	4.40	0.64	4.70	0.65	5.00	0.65	5.30	0.66	5.50	0.67
	0.0	3.90	0.82	4.40	0.83	4.70	0.84	5.00	0.85	5.30	0.86	5.50	0.86
	5.0	3.90	0.70	4.40	0.71	4.70	0.71	5.00	0.72	5.30	0.73	5.50	0.73
	10.0	3.90	0.38	4.40	0.39	4.70	0.39	5.00	0.40	5.30	0.40	5.50	0.40
	15.0	3.90	0.51	4.40	0.52	4.70	0.52	5.00	0.53	5.30	0.53	5.50	0.54
	20.0	3.90	0.67	4.40	0.68	4.70	0.69	5.00	0.69	5.30	0.70	5.50	0.71
	25.0	3.90	0.83	4.40	0.84	4.70	0.85	5.00	0.86	5.30	0.87	5.50	0.87
	30.0	3.90	0.97	4.40	0.98	4.70	0.99	5.00	1.00	5.30	1.01	5.50	1.02
	35.0	3.90	1.24	4.40	1.26	4.70	1.27	5.00	1.29	5.30	1.30	5.50	1.31
	40.0	3.10	1.01	3.50	1.03	3.70	1.04	3.90	1.05	4.20	1.06	4.30	1.06
12	-10.0	3.37	0.38	3.81	0.39	4.02	0.39	4.30	0.40	4.60	0.40	4.74	0.40
	0.0	3.37	0.71	3.81	0.72	4.02	0.73	4.30	0.74	4.60	0.75	4.74	0.75
	5.0	3.37	0.61	3.81	0.62	4.02	0.62	4.30	0.63	4.60	0.64	4.74	0.64
	10.0	3.37	0.33	3.81	0.34	4.02	0.34	4.30	0.35	4.60	0.35	4.74	0.35
	15.0	3.37	0.44	3.81	0.45	4.02	0.45	4.30	0.46	4.60	0.46	4.74	0.47
	20.0	3.37	0.58	3.81	0.59	4.02	0.60	4.30	0.60	4.60	0.61	4.74	0.61
	25.0	3.37	0.72	3.81	0.73	4.02	0.74	4.30	0.75	4.60	0.76	4.74	0.76
	30.0	3.37	0.84	3.81	0.86	4.02	0.86	4.30	0.87	4.60	0.88	4.74	0.89
	35.0	3.37	1.08	3.81	1.10	4.02	1.11	4.30	1.12	4.60	1.13	4.74	1.14
	40.0	2.65	0.88	3.00	0.89	3.16	0.90	3.38	0.91	3.62	0.92	3.73	0.93
10	-10.0	2.82	0.32	3.19	0.33	3.36	0.33	3.60	0.33	3.85	0.34	3.97	0.34
	0.0	2.82	0.60	3.19	0.61	3.36	0.61	3.60	0.62	3.85	0.63	3.97	0.63
	5.0	2.82	0.51	3.19	0.52	3.36	0.52	3.60	0.53	3.85	0.53	3.97	0.54
	10.0	2.82	0.28	3.19	0.29	3.36	0.29	3.60	0.29	3.85	0.29	3.97	0.30
	15.0	2.82	0.37	3.19	0.38	3.36	0.38	3.60	0.38	3.85	0.39	3.97	0.39
	20.0	2.82	0.49	3.19	0.50	3.36	0.50	3.60	0.51	3.85	0.51	3.97	0.52
	25.0	2.82	0.61	3.19	0.62	3.36	0.62	3.60	0.63	3.85	0.64	3.97	0.64
	30.0	2.82	0.71	3.19	0.72	3.36	0.72	3.60	0.73	3.85	0.74	3.97	0.74
	35.0	2.82	0.91	3.19	0.92	3.36	0.93	3.60	0.94	3.85	0.95	3.97	0.96
	40.0	2.22	0.74	2.51	0.75	2.65	0.76	2.83	0.77	3.03	0.77	3.12	0.78
	46.0	2.22	0.57	2.51	0.58	2.65	0.58	2.83	0.59	3.03	0.60	3.12	0.60

NOTES:

- TC: Total Capacity (kW), IP: Input Power (kW)
- Values mentioned in the table are based on the following conditions:
 - Power source of specifications: 230 V
 - Pipe length: 5 m, Height difference: 0 m (Outdoor unit—Indoor unit)
- 2 or more indoor units should be connected.
- The total ability of connected indoor unit is from 10,000 Btu/h up to 26,000 Btu/h.
- Input in the table are calculated based on the maximum indoor unit input combinations.

● Compact cassette type

Model: AUXG07KVLA

Outdoor temperature	Indoor temperature (°CDB / °CWB)											
	18.0 / 12.0		21.0 / 15.0		23.0 / 16.0		27.0 / 19.0		29.0 / 21.0		32.0 / 23.0	
(°CDB)	TC	SHC	TC	SHC	TC	SHC	TC	SHC	TC	SHC	TC	SHC
-10.0	1.96	1.32	2.22	1.51	2.34	1.74	2.50	1.95	2.67	2.13	2.76	2.44
0.0	1.96	1.32	2.22	1.51	2.34	1.74	2.50	1.95	2.67	2.13	2.76	2.44
5.0	1.96	1.32	2.22	1.51	2.34	1.74	2.50	1.95	2.67	2.13	2.76	2.44
10.0	1.96	1.32	2.22	1.51	2.34	1.74	2.50	1.95	2.67	2.13	2.76	2.44
15.0	1.96	1.32	2.22	1.51	2.34	1.74	2.50	1.95	2.67	2.13	2.76	2.44
20.0	1.96	1.32	2.22	1.51	2.34	1.74	2.50	1.95	2.67	2.13	2.76	2.44
25.0	1.96	1.32	2.22	1.51	2.34	1.74	2.50	1.95	2.67	2.13	2.76	2.44
30.0	1.96	1.32	2.22	1.51	2.34	1.74	2.50	1.95	2.67	2.13	2.76	2.44
35.0	1.96	1.32	2.22	1.51	2.34	1.74	2.50	1.95	2.67	2.13	2.76	2.44
40.0	1.85	1.18	2.10	1.35	2.21	1.55	2.37	1.75	2.53	1.91	2.61	2.19
46.0	1.75	1.05	1.98	1.20	2.08	1.38	2.23	1.55	2.38	1.70	2.46	1.95

Model: AUXG09KVLA

Outdoor temperature	Indoor temperature (°CDB / °CWB)											
	18.0 / 12.0		21.0 / 15.0		23.0 / 16.0		27.0 / 19.0		29.0 / 21.0		32.0 / 23.0	
(°CDB)	TC	SHC	TC	SHC	TC	SHC	TC	SHC	TC	SHC	TC	SHC
-10.0	2.51	1.67	2.84	1.90	2.99	2.19	3.20	2.46	3.42	2.69	3.53	3.09
0.0	2.51	1.67	2.84	1.90	2.99	2.19	3.20	2.46	3.42	2.69	3.53	3.09
5.0	2.51	1.67	2.84	1.90	2.99	2.19	3.20	2.46	3.42	2.69	3.53	3.09
10.0	2.51	1.67	2.84	1.90	2.99	2.19	3.20	2.46	3.42	2.69	3.53	3.09
15.0	2.51	1.67	2.84	1.90	2.99	2.19	3.20	2.46	3.42	2.69	3.53	3.09
20.0	2.51	1.67	2.84	1.90	2.99	2.19	3.20	2.46	3.42	2.69	3.53	3.09
25.0	2.51	1.67	2.84	1.90	2.99	2.19	3.20	2.46	3.42	2.69	3.53	3.09
30.0	2.51	1.67	2.84	1.90	2.99	2.19	3.20	2.46	3.42	2.69	3.53	3.09
35.0	2.51	1.67	2.84	1.90	2.99	2.19	3.20	2.46	3.42	2.69	3.53	3.09
40.0	2.37	1.50	2.68	1.71	2.83	1.96	3.03	2.21	3.24	2.41	3.34	2.76
46.0	2.24	1.33	2.53	1.52	2.67	1.75	2.86	1.96	3.05	2.15	3.15	2.46

Model: AUXG12KVLA

Outdoor temperature	Indoor temperature (°CDB / °CWB)											
	18.0 / 12.0		21.0 / 15.0		23.0 / 16.0		27.0 / 19.0		29.0 / 21.0		32.0 / 23.0	
(°CDB)	TC	SHC	TC	SHC	TC	SHC	TC	SHC	TC	SHC	TC	SHC
-10.0	2.87	1.89	3.24	2.15	3.42	2.48	3.66	2.78	3.91	3.04	4.03	3.49
0.0	2.87	1.89	3.24	2.15	3.42	2.48	3.66	2.78	3.91	3.04	4.03	3.49
5.0	2.87	1.89	3.24	2.15	3.42	2.48	3.66	2.78	3.91	3.04	4.03	3.49
10.0	2.87	1.89	3.24	2.15	3.42	2.48	3.66	2.78	3.91	3.04	4.03	3.49
15.0	2.87	1.89	3.24	2.15	3.42	2.48	3.66	2.78	3.91	3.04	4.03	3.49
20.0	2.87	1.89	3.24	2.15	3.42	2.48	3.66	2.78	3.91	3.04	4.03	3.49
25.0	2.87	1.89	3.24	2.15	3.42	2.48	3.66	2.78	3.91	3.04	4.03	3.49
30.0	2.87	1.89	3.24	2.15	3.42	2.48	3.66	2.78	3.91	3.04	4.03	3.49
35.0	2.87	1.89	3.24	2.15	3.42	2.48	3.66	2.78	3.91	3.04	4.03	3.49
40.0	2.72	1.69	3.07	1.93	3.23	2.22	3.46	2.49	3.70	2.72	3.82	3.12
46.0	2.56	1.50	2.89	1.71	3.05	1.97	3.27	2.22	3.49	2.42	3.60	2.78

Model: AUXG14KVLA

Outdoor temperature	Indoor temperature (°CDB / °CWB)											
	18.0 / 12.0		21.0 / 15.0		23.0 / 16.0		27.0 / 19.0		29.0 / 21.0		32.0 / 23.0	
(°CDB)	TC	SHC	TC	SHC	TC	SHC	TC	SHC	TC	SHC	TC	SHC
-10.0	3.03	1.89	3.43	2.15	3.61	2.48	3.87	2.79	4.14	3.05	4.26	3.49
0.0	3.03	1.89	3.43	2.15	3.61	2.48	3.87	2.79	4.14	3.05	4.26	3.49
5.0	3.03	1.89	3.43	2.15	3.61	2.48	3.87	2.79	4.14	3.05	4.26	3.49
10.0	3.03	1.89	3.43	2.15	3.61	2.48	3.87	2.79	4.14	3.05	4.26	3.49
15.0	3.03	1.89	3.43	2.15	3.61	2.48	3.87	2.79	4.14	3.05	4.26	3.49
20.0	3.03	1.89	3.43	2.15	3.61	2.48	3.87	2.79	4.14	3.05	4.26	3.49
25.0	3.03	1.89	3.43	2.15	3.61	2.48	3.87	2.79	4.14	3.05	4.26	3.49
30.0	3.03	1.89	3.43	2.15	3.61	2.48	3.87	2.79	4.14	3.05	4.26	3.49
35.0	3.03	1.89	3.43	2.15	3.61	2.48	3.87	2.79	4.14	3.05	4.26	3.49
40.0	2.87	1.69	3.24	1.93	3.42	2.22	3.66	2.49	3.91	2.73	4.04	3.13
46.0	2.71	1.50	3.06	1.72	3.23	1.97	3.45	2.22	3.69	2.43	3.81	2.78

NOTES:

- TC: Total Capacity (kW), SHC: Sensible Heat Capacity (kW)
- Values mentioned in the table are based on the following conditions:
 - Pipe length: 5 m, Height difference: 0 m (Outdoor unit—Indoor unit)

● Mini duct type

Model: ARXG07KSLAP

Outdoor temperature	Indoor temperature (°CDB / °CWB)											
	18.0 / 12.0		21.0 / 15.0		23.0 / 16.0		27.0 / 19.0		29.0 / 21.0		32.0 / 23.0	
(°CDB)	TC	SHC	TC	SHC	TC	SHC	TC	SHC	TC	SHC	TC	SHC
-10.0	1.96	1.36	2.22	1.55	2.34	1.78	2.50	2.00	2.67	2.19	2.76	2.51
0.0	1.96	1.36	2.22	1.55	2.34	1.78	2.50	2.00	2.67	2.19	2.76	2.51
5.0	1.96	1.36	2.22	1.55	2.34	1.78	2.50	2.00	2.67	2.19	2.76	2.51
10.0	1.96	1.36	2.22	1.55	2.34	1.78	2.50	2.00	2.67	2.19	2.76	2.51
15.0	1.96	1.36	2.22	1.55	2.34	1.78	2.50	2.00	2.67	2.19	2.76	2.51
20.0	1.96	1.36	2.22	1.55	2.34	1.78	2.50	2.00	2.67	2.19	2.76	2.51
25.0	1.96	1.36	2.22	1.55	2.34	1.78	2.50	2.00	2.67	2.19	2.76	2.51
30.0	1.96	1.36	2.22	1.55	2.34	1.78	2.50	2.00	2.67	2.19	2.76	2.51
35.0	1.96	1.36	2.22	1.55	2.34	1.78	2.50	2.00	2.67	2.19	2.76	2.51
40.0	1.54	0.84	1.74	0.96	1.84	1.10	1.97	1.24	2.10	1.35	2.17	1.55
46.0	1.12	0.45	1.27	0.51	1.34	0.59	1.43	0.66	1.53	0.72	1.58	0.83

Model: ARXG09KSLAP

Outdoor temperature	Indoor temperature (°CDB / °CWB)											
	18.0 / 12.0		21.0 / 15.0		23.0 / 16.0		27.0 / 19.0		29.0 / 21.0		32.0 / 23.0	
(°CDB)	TC	SHC	TC	SHC	TC	SHC	TC	SHC	TC	SHC	TC	SHC
-10.0	2.51	1.61	2.84	1.83	2.99	2.11	3.20	2.37	3.42	2.59	3.53	2.97
0.0	2.51	1.61	2.84	1.83	2.99	2.11	3.20	2.37	3.42	2.59	3.53	2.97
5.0	2.51	1.61	2.84	1.83	2.99	2.11	3.20	2.37	3.42	2.59	3.53	2.97
10.0	2.51	1.61	2.84	1.83	2.99	2.11	3.20	2.37	3.42	2.59	3.53	2.97
15.0	2.51	1.61	2.84	1.83	2.99	2.11	3.20	2.37	3.42	2.59	3.53	2.97
20.0	2.51	1.61	2.84	1.83	2.99	2.11	3.20	2.37	3.42	2.59	3.53	2.97
25.0	2.51	1.61	2.84	1.83	2.99	2.11	3.20	2.37	3.42	2.59	3.53	2.97
30.0	2.51	1.61	2.84	1.83	2.99	2.11	3.20	2.37	3.42	2.59	3.53	2.97
35.0	2.51	1.61	2.84	1.83	2.99	2.11	3.20	2.37	3.42	2.59	3.53	2.97
40.0	1.97	0.99	2.23	1.13	2.35	1.31	2.52	1.47	2.69	1.60	2.78	1.84
46.0	1.44	0.53	1.63	0.60	1.72	0.69	1.84	0.78	1.96	0.85	2.02	0.98

Model: ARXG12KSLAP

Outdoor temperature	Indoor temperature (°CDB / °CWB)											
	18.0 / 12.0		21.0 / 15.0		23.0 / 16.0		27.0 / 19.0		29.0 / 21.0		32.0 / 23.0	
(°CDB)	TC	SHC	TC	SHC	TC	SHC	TC	SHC	TC	SHC	TC	SHC
-10.0	2.87	1.84	3.24	2.09	3.42	2.41	3.66	2.71	3.91	2.96	4.03	3.39
0.0	2.87	1.84	3.24	2.09	3.42	2.41	3.66	2.71	3.91	2.96	4.03	3.39
5.0	2.87	1.84	3.24	2.09	3.42	2.41	3.66	2.71	3.91	2.96	4.03	3.39
10.0	2.87	1.84	3.24	2.09	3.42	2.41	3.66	2.71	3.91	2.96	4.03	3.39
15.0	2.87	1.84	3.24	2.09	3.42	2.41	3.66	2.71	3.91	2.96	4.03	3.39
20.0	2.87	1.84	3.24	2.09	3.42	2.41	3.66	2.71	3.91	2.96	4.03	3.39
25.0	2.87	1.84	3.24	2.09	3.42	2.41	3.66	2.71	3.91	2.96	4.03	3.39
30.0	2.87	1.84	3.24	2.09	3.42	2.41	3.66	2.71	3.91	2.96	4.03	3.39
35.0	2.87	1.84	3.24	2.09	3.42	2.41	3.66	2.71	3.91	2.96	4.03	3.39
40.0	2.26	1.14	2.55	1.30	2.69	1.49	2.88	1.68	3.08	1.83	3.17	2.10
46.0	1.65	0.60	1.86	0.69	1.96	0.79	2.10	0.89	2.25	0.98	2.31	1.12

Model: ARXG14KSLAP

Outdoor temperature	Indoor temperature (°CDB / °CWB)											
	18.0 / 12.0		21.0 / 15.0		23.0 / 16.0		27.0 / 19.0		29.0 / 21.0		32.0 / 23.0	
(°CDB)	TC	SHC	TC	SHC	TC	SHC	TC	SHC	TC	SHC	TC	SHC
-10.0	3.03	1.86	3.43	2.12	3.61	2.45	3.87	2.75	4.14	3.01	4.26	3.44
0.0	3.03	1.86	3.43	2.12	3.61	2.45	3.87	2.75	4.14	3.01	4.26	3.44
5.0	3.03	1.86	3.43	2.12	3.61	2.45	3.87	2.75	4.14	3.01	4.26	3.44
10.0	3.03	1.86	3.43	2.12	3.61	2.45	3.87	2.75	4.14	3.01	4.26	3.44
15.0	3.03	1.86	3.43	2.12	3.61	2.45	3.87	2.75	4.14	3.01	4.26	3.44
20.0	3.03	1.86	3.43	2.12	3.61	2.45	3.87	2.75	4.14	3.01	4.26	3.44
25.0	3.03	1.86	3.43	2.12	3.61	2.45	3.87	2.75	4.14	3.01	4.26	3.44
30.0	3.03	1.86	3.43	2.12	3.61	2.45	3.87	2.75	4.14	3.01	4.26	3.44
35.0	3.03	1.86	3.43	2.12	3.61	2.45	3.87	2.75	4.14	3.01	4.26	3.44
40.0	2.39	1.15	2.70	1.32	2.84	1.51	3.05	1.70	3.26	1.86	3.36	2.13
46.0	1.74	0.61	1.97	0.70	2.07	0.81	2.22	0.91	2.37	0.99	2.45	1.13

NOTES:

- TC: Total Capacity (kW), SHC: Sensible Heat Capacity (kW)
- Values mentioned in the table are based on the following conditions:
 - Pipe length: 5 m, Height difference: 0 m [Outdoor unit—Indoor unit]

● Slim duct type

Model: ARXG07KLLAP

Outdoor temperature (°CDB)	Indoor temperature (°CDB / °CWB)											
	18.0 / 12.0		21.0 / 15.0		23.0 / 16.0		27.0 / 19.0		29.0 / 21.0		32.0 / 23.0	
	TC	SHC	TC	SHC	TC	SHC	TC	SHC	TC	SHC	TC	SHC
-10.0	1.96	1.36	2.22	1.55	2.34	1.78	2.50	2.00	2.67	2.19	2.76	2.51
0.0	1.96	1.36	2.22	1.55	2.34	1.78	2.50	2.00	2.67	2.19	2.76	2.51
5.0	1.96	1.36	2.22	1.55	2.34	1.78	2.50	2.00	2.67	2.19	2.76	2.51
10.0	1.96	1.36	2.22	1.55	2.34	1.78	2.50	2.00	2.67	2.19	2.76	2.51
15.0	1.96	1.36	2.22	1.55	2.34	1.78	2.50	2.00	2.67	2.19	2.76	2.51
20.0	1.96	1.36	2.22	1.55	2.34	1.78	2.50	2.00	2.67	2.19	2.76	2.51
25.0	1.96	1.36	2.22	1.55	2.34	1.78	2.50	2.00	2.67	2.19	2.76	2.51
30.0	1.96	1.36	2.22	1.55	2.34	1.78	2.50	2.00	2.67	2.19	2.76	2.51
35.0	1.96	1.36	2.22	1.55	2.34	1.78	2.50	2.00	2.67	2.19	2.76	2.51
40.0	1.54	0.84	1.74	0.96	1.84	1.10	1.97	1.24	2.10	1.35	2.17	1.55
46.0	1.12	0.45	1.27	0.51	1.34	0.59	1.43	0.66	1.53	0.72	1.58	0.83

Model: ARXG09KLLAP

Outdoor temperature (°CDB)	Indoor temperature (°CDB / °CWB)											
	18.0 / 12.0		21.0 / 15.0		23.0 / 16.0		27.0 / 19.0		29.0 / 21.0		32.0 / 23.0	
	TC	SHC	TC	SHC	TC	SHC	TC	SHC	TC	SHC	TC	SHC
-10.0	2.51	1.67	2.84	1.90	2.99	2.19	3.20	2.46	3.42	2.69	3.53	3.09
0.0	2.51	1.67	2.84	1.90	2.99	2.19	3.20	2.46	3.42	2.69	3.53	3.09
5.0	2.51	1.67	2.84	1.90	2.99	2.19	3.20	2.46	3.42	2.69	3.53	3.09
10.0	2.51	1.67	2.84	1.90	2.99	2.19	3.20	2.46	3.42	2.69	3.53	3.09
15.0	2.51	1.67	2.84	1.90	2.99	2.19	3.20	2.46	3.42	2.69	3.53	3.09
20.0	2.51	1.67	2.84	1.90	2.99	2.19	3.20	2.46	3.42	2.69	3.53	3.09
25.0	2.51	1.67	2.84	1.90	2.99	2.19	3.20	2.46	3.42	2.69	3.53	3.09
30.0	2.51	1.67	2.84	1.90	2.99	2.19	3.20	2.46	3.42	2.69	3.53	3.09
35.0	2.51	1.67	2.84	1.90	2.99	2.19	3.20	2.46	3.42	2.69	3.53	3.09
40.0	1.97	1.03	2.23	1.18	2.35	1.36	2.52	1.53	2.69	1.67	2.78	1.91
46.0	1.44	0.55	1.63	0.63	1.72	0.72	1.84	0.81	1.96	0.89	2.02	1.02

Model: ARXG12KLLAP

Outdoor temperature (°CDB)	Indoor temperature (°CDB / °CWB)											
	18.0 / 12.0		21.0 / 15.0		23.0 / 16.0		27.0 / 19.0		29.0 / 21.0		32.0 / 23.0	
	TC	SHC	TC	SHC	TC	SHC	TC	SHC	TC	SHC	TC	SHC
-10.0	2.87	1.94	3.24	2.21	3.42	2.54	3.66	2.85	3.91	3.12	4.03	3.58
0.0	2.87	1.94	3.24	2.21	3.42	2.54	3.66	2.85	3.91	3.12	4.03	3.58
5.0	2.87	1.94	3.24	2.21	3.42	2.54	3.66	2.85	3.91	3.12	4.03	3.58
10.0	2.87	1.94	3.24	2.21	3.42	2.54	3.66	2.85	3.91	3.12	4.03	3.58
15.0	2.87	1.94	3.24	2.21	3.42	2.54	3.66	2.85	3.91	3.12	4.03	3.58
20.0	2.87	1.94	3.24	2.21	3.42	2.54	3.66	2.85	3.91	3.12	4.03	3.58
25.0	2.87	1.94	3.24	2.21	3.42	2.54	3.66	2.85	3.91	3.12	4.03	3.58
30.0	2.87	1.94	3.24	2.21	3.42	2.54	3.66	2.85	3.91	3.12	4.03	3.58
35.0	2.87	1.94	3.24	2.21	3.42	2.54	3.66	2.85	3.91	3.12	4.03	3.58
40.0	2.26	1.20	2.55	1.37	2.69	1.57	2.88	1.77	3.08	1.93	3.17	2.22
46.0	1.65	0.64	1.86	0.73	1.96	0.84	2.10	0.94	2.25	1.03	2.31	1.18

Model: ARXG14KLLAP

Outdoor temperature (°CDB)	Indoor temperature (°CDB / °CWB)											
	18.0 / 12.0		21.0 / 15.0		23.0 / 16.0		27.0 / 19.0		29.0 / 21.0		32.0 / 23.0	
	TC	SHC	TC	SHC	TC	SHC	TC	SHC	TC	SHC	TC	SHC
-10.0	3.03	1.94	3.43	2.21	3.61	2.55	3.87	2.86	4.14	3.13	4.26	3.59
0.0	3.03	1.94	3.43	2.21	3.61	2.55	3.87	2.86	4.14	3.13	4.26	3.59
5.0	3.03	1.94	3.43	2.21	3.61	2.55	3.87	2.86	4.14	3.13	4.26	3.59
10.0	3.03	1.94	3.43	2.21	3.61	2.55	3.87	2.86	4.14	3.13	4.26	3.59
15.0	3.03	1.94	3.43	2.21	3.61	2.55	3.87	2.86	4.14	3.13	4.26	3.59
20.0	3.03	1.94	3.43	2.21	3.61	2.55	3.87	2.86	4.14	3.13	4.26	3.59
25.0	3.03	1.94	3.43	2.21	3.61	2.55	3.87	2.86	4.14	3.13	4.26	3.59
30.0	3.03	1.94	3.43	2.21	3.61	2.55	3.87	2.86	4.14	3.13	4.26	3.59
35.0	3.03	1.94	3.43	2.21	3.61	2.55	3.87	2.86	4.14	3.13	4.26	3.59
40.0	2.39	1.20	2.70	1.37	2.84	1.58	3.05	1.77	3.26	1.94	3.36	2.22
46.0	1.74	0.64	1.97	0.73	2.07	0.84	2.22	0.94	2.37	1.03	2.45	1.18

NOTES:

- TC: Total Capacity (kW), SHC: Sensible Heat Capacity (kW)
- Values mentioned in the table are based on the following conditions:
 - Pipe length: 5 m, Height difference: 0 m (Outdoor unit—Indoor unit)

● Medium static pressure duct type

Model: ARXH12KMTAP

Outdoor temperature	Indoor temperature (°CDB / °CWB)											
	18.0 / 12.0		21.0 / 15.0		23.0 / 16.0		27.0 / 19.0		29.0 / 21.0		32.0 / 23.0	
(°CDB)	TC	SHC	TC	SHC	TC	SHC	TC	SHC	TC	SHC	TC	SHC
-10.0	2.87	1.94	3.24	2.21	3.42	2.54	3.66	2.85	3.91	3.12	4.03	3.58
0.0	2.87	1.94	3.24	2.21	3.42	2.54	3.66	2.85	3.91	3.12	4.03	3.58
5.0	2.87	1.94	3.24	2.21	3.42	2.54	3.66	2.85	3.91	3.12	4.03	3.58
10.0	2.87	1.94	3.24	2.21	3.42	2.54	3.66	2.85	3.91	3.12	4.03	3.58
15.0	2.87	1.94	3.24	2.21	3.42	2.54	3.66	2.85	3.91	3.12	4.03	3.58
20.0	2.87	1.94	3.24	2.21	3.42	2.54	3.66	2.85	3.91	3.12	4.03	3.58
25.0	2.87	1.94	3.24	2.21	3.42	2.54	3.66	2.85	3.91	3.12	4.03	3.58
30.0	2.87	1.94	3.24	2.21	3.42	2.54	3.66	2.85	3.91	3.12	4.03	3.58
35.0	2.87	1.94	3.24	2.21	3.42	2.54	3.66	2.85	3.91	3.12	4.03	3.58
40.0	2.26	1.20	2.55	1.37	2.69	1.57	2.88	1.77	3.08	1.93	3.17	2.22
46.0	1.65	0.64	1.86	0.73	1.96	0.84	2.10	0.94	2.25	1.03	2.31	1.18

Model: ARXH14KMTAP

Outdoor temperature	Indoor temperature (°CDB / °CWB)											
	18.0 / 12.0		21.0 / 15.0		23.0 / 16.0		27.0 / 19.0		29.0 / 21.0		32.0 / 23.0	
(°CDB)	TC	SHC	TC	SHC	TC	SHC	TC	SHC	TC	SHC	TC	SHC
-10.0	3.03	2.03	3.43	2.31	3.61	2.67	3.87	2.99	4.14	3.28	4.26	3.76
0.0	3.03	2.03	3.43	2.31	3.61	2.67	3.87	2.99	4.14	3.28	4.26	3.76
5.0	3.03	2.03	3.43	2.31	3.61	2.67	3.87	2.99	4.14	3.28	4.26	3.76
10.0	3.03	2.03	3.43	2.31	3.61	2.67	3.87	2.99	4.14	3.28	4.26	3.76
15.0	3.03	2.03	3.43	2.31	3.61	2.67	3.87	2.99	4.14	3.28	4.26	3.76
20.0	3.03	2.03	3.43	2.31	3.61	2.67	3.87	2.99	4.14	3.28	4.26	3.76
25.0	3.03	2.03	3.43	2.31	3.61	2.67	3.87	2.99	4.14	3.28	4.26	3.76
30.0	3.03	2.03	3.43	2.31	3.61	2.67	3.87	2.99	4.14	3.28	4.26	3.76
35.0	3.03	2.03	3.43	2.31	3.61	2.67	3.87	2.99	4.14	3.28	4.26	3.76
40.0	2.39	1.26	2.70	1.43	2.84	1.65	3.05	1.85	3.26	2.03	3.36	2.32
46.0	1.74	0.67	1.97	0.76	2.07	0.88	2.22	0.98	2.37	1.08	2.45	1.24

NOTES:

- TC: Total Capacity (kW), SHC: Sensible Heat Capacity (kW).
- Values mentioned in the table are based on the following conditions:
 - Pipe length: 5 m, Height difference: 0 m (Outdoor unit—Indoor unit)

● Wall mounted type

Model: ASEH07KMCG, ASEH07KMCG-B

Outdoor temperature	Indoor temperature (°CDB / °CWB)											
	18.0 / 12.0		21.0 / 15.0		23.0 / 16.0		27.0 / 19.0		29.0 / 21.0		32.0 / 23.0	
(°CDB)	TC	SHC	TC	SHC	TC	SHC	TC	SHC	TC	SHC	TC	SHC
-10.0	1.96	1.10	2.22	1.26	2.34	1.45	2.50	1.63	2.67	1.78	2.76	2.04
0.0	1.96	1.10	2.22	1.26	2.34	1.45	2.50	1.63	2.67	1.78	2.76	2.04
5.0	1.96	1.10	2.22	1.26	2.34	1.45	2.50	1.63	2.67	1.78	2.76	2.04
10.0	1.96	1.10	2.22	1.26	2.34	1.45	2.50	1.63	2.67	1.78	2.76	2.04
15.0	1.96	1.10	2.22	1.26	2.34	1.45	2.50	1.63	2.67	1.78	2.76	2.04
20.0	1.96	1.10	2.22	1.26	2.34	1.45	2.50	1.63	2.67	1.78	2.76	2.04
25.0	1.96	1.10	2.22	1.26	2.34	1.45	2.50	1.63	2.67	1.78	2.76	2.04
30.0	1.96	1.10	2.22	1.26	2.34	1.45	2.50	1.63	2.67	1.78	2.76	2.04
35.0	1.96	1.10	2.22	1.26	2.34	1.45	2.50	1.63	2.67	1.78	2.76	2.04
40.0	1.54	0.68	1.74	0.78	1.84	0.90	1.97	1.01	2.10	1.10	2.17	1.26
46.0	1.12	0.36	1.27	0.41	1.34	0.48	1.43	0.54	1.53	0.59	1.58	0.67

Model: ASEH09KMCG, ASEH09KMCG-B

Outdoor temperature	Indoor temperature (°CDB / °CWB)											
	18.0 / 12.0		21.0 / 15.0		23.0 / 16.0		27.0 / 19.0		29.0 / 21.0		32.0 / 23.0	
(°CDB)	TC	SHC	TC	SHC	TC	SHC	TC	SHC	TC	SHC	TC	SHC
-10.0	2.51	1.41	2.84	1.61	2.99	1.85	3.20	2.08	3.42	2.27	3.53	2.61
0.0	2.51	1.41	2.84	1.61	2.99	1.85	3.20	2.08	3.42	2.27	3.53	2.61
5.0	2.51	1.41	2.84	1.61	2.99	1.85	3.20	2.08	3.42	2.27	3.53	2.61
10.0	2.51	1.41	2.84	1.61	2.99	1.85	3.20	2.08	3.42	2.27	3.53	2.61
15.0	2.51	1.41	2.84	1.61	2.99	1.85	3.20	2.08	3.42	2.27	3.53	2.61
20.0	2.51	1.41	2.84	1.61	2.99	1.85	3.20	2.08	3.42	2.27	3.53	2.61
25.0	2.51	1.41	2.84	1.61	2.99	1.85	3.20	2.08	3.42	2.27	3.53	2.61
30.0	2.51	1.41	2.84	1.61	2.99	1.85	3.20	2.08	3.42	2.27	3.53	2.61
35.0	2.51	1.41	2.84	1.61	2.99	1.85	3.20	2.08	3.42	2.27	3.53	2.61
40.0	1.97	0.87	2.23	1.00	2.35	1.15	2.52	1.29	2.69	1.41	2.78	1.61
46.0	1.44	0.46	1.63	0.53	1.72	0.61	1.84	0.69	1.96	0.75	2.02	0.86

Model: ASEH12KMCG, ASEH12KMCG-B

Outdoor temperature	Indoor temperature (°CDB / °CWB)											
	18.0 / 12.0		21.0 / 15.0		23.0 / 16.0		27.0 / 19.0		29.0 / 21.0		32.0 / 23.0	
(°CDB)	TC	SHC	TC	SHC	TC	SHC	TC	SHC	TC	SHC	TC	SHC
-10.0	2.87	1.61	3.24	1.84	3.42	2.12	3.66	2.38	3.91	2.60	4.03	2.98
0.0	2.87	1.61	3.24	1.84	3.42	2.12	3.66	2.38	3.91	2.60	4.03	2.98
5.0	2.87	1.61	3.24	1.84	3.42	2.12	3.66	2.38	3.91	2.60	4.03	2.98
10.0	2.87	1.61	3.24	1.84	3.42	2.12	3.66	2.38	3.91	2.60	4.03	2.98
15.0	2.87	1.61	3.24	1.84	3.42	2.12	3.66	2.38	3.91	2.60	4.03	2.98
20.0	2.87	1.61	3.24	1.84	3.42	2.12	3.66	2.38	3.91	2.60	4.03	2.98
25.0	2.87	1.61	3.24	1.84	3.42	2.12	3.66	2.38	3.91	2.60	4.03	2.98
30.0	2.87	1.61	3.24	1.84	3.42	2.12	3.66	2.38	3.91	2.60	4.03	2.98
35.0	2.87	1.61	3.24	1.84	3.42	2.12	3.66	2.38	3.91	2.60	4.03	2.98
40.0	2.26	1.00	2.55	1.14	2.69	1.31	2.88	1.47	3.08	1.61	3.17	1.85
46.0	1.65	0.53	1.86	0.61	1.96	0.70	2.10	0.78	2.25	0.86	2.31	0.98

Model: ASEH14KMCG, ASEH14KMCG-B

Outdoor temperature	Indoor temperature (°CDB / °CWB)											
	18.0 / 12.0		21.0 / 15.0		23.0 / 16.0		27.0 / 19.0		29.0 / 21.0		32.0 / 23.0	
(°CDB)	TC	SHC	TC	SHC	TC	SHC	TC	SHC	TC	SHC	TC	SHC
-10.0	3.03	1.71	3.43	1.94	3.61	2.24	3.87	2.52	4.14	2.75	4.26	3.15
0.0	3.03	1.71	3.43	1.94	3.61	2.24	3.87	2.52	4.14	2.75	4.26	3.15
5.0	3.03	1.71	3.43	1.94	3.61	2.24	3.87	2.52	4.14	2.75	4.26	3.15
10.0	3.03	1.71	3.43	1.94	3.61	2.24	3.87	2.52	4.14	2.75	4.26	3.15
15.0	3.03	1.71	3.43	1.94	3.61	2.24	3.87	2.52	4.14	2.75	4.26	3.15
20.0	3.03	1.71	3.43	1.94	3.61	2.24	3.87	2.52	4.14	2.75	4.26	3.15
25.0	3.03	1.71	3.43	1.94	3.61	2.24	3.87	2.52	4.14	2.75	4.26	3.15
30.0	3.03	1.71	3.43	1.94	3.61	2.24	3.87	2.52	4.14	2.75	4.26	3.15
35.0	3.03	1.71	3.43	1.94	3.61	2.24	3.87	2.52	4.14	2.75	4.26	3.15
40.0	2.39	1.06	2.70	1.20	2.84	1.39	3.05	1.56	3.26	1.70	3.36	1.95
46.0	1.74	0.56	1.97	0.64	2.07	0.74	2.22	0.83	2.37	0.91	2.45	1.04

Models: ASEG07KETF and ASEG07KETF-B

Outdoor temperature	Indoor temperature (°CDB / °CWB)											
	18.0 / 12.0		21.0 / 15.0		23.0 / 16.0		27.0 / 19.0		29.0 / 21.0		32.0 / 23.0	
(°CDB)	TC	SHC	TC	SHC	TC	SHC	TC	SHC	TC	SHC	TC	SHC
-10.0	1.96	1.10	2.22	1.26	2.34	1.45	2.50	1.63	2.67	1.78	2.76	2.04
0.0	1.96	1.10	2.22	1.26	2.34	1.45	2.50	1.63	2.67	1.78	2.76	2.04
5.0	1.96	1.10	2.22	1.26	2.34	1.45	2.50	1.63	2.67	1.78	2.76	2.04
10.0	1.96	1.10	2.22	1.26	2.34	1.45	2.50	1.63	2.67	1.78	2.76	2.04
15.0	1.96	1.10	2.22	1.26	2.34	1.45	2.50	1.63	2.67	1.78	2.76	2.04
20.0	1.96	1.10	2.22	1.26	2.34	1.45	2.50	1.63	2.67	1.78	2.76	2.04
25.0	1.96	1.10	2.22	1.26	2.34	1.45	2.50	1.63	2.67	1.78	2.76	2.04
30.0	1.96	1.10	2.22	1.26	2.34	1.45	2.50	1.63	2.67	1.78	2.76	2.04
35.0	1.96	1.10	2.22	1.26	2.34	1.45	2.50	1.63	2.67	1.78	2.76	2.04
40.0	1.54	0.68	1.74	0.78	1.84	0.90	1.97	1.01	2.10	1.10	2.17	1.26
46.0	1.12	0.36	1.27	0.41	1.34	0.48	1.43	0.54	1.53	0.59	1.58	0.67

Models: ASEG09KETF and ASEG09KETF-B

Outdoor temperature	Indoor temperature (°CDB / °CWB)											
	18.0 / 12.0		21.0 / 15.0		23.0 / 16.0		27.0 / 19.0		29.0 / 21.0		32.0 / 23.0	
(°CDB)	TC	SHC	TC	SHC	TC	SHC	TC	SHC	TC	SHC	TC	SHC
-10.0	2.51	1.41	2.84	1.61	2.99	1.85	3.20	2.08	3.42	2.27	3.53	2.61
0.0	2.51	1.41	2.84	1.61	2.99	1.85	3.20	2.08	3.42	2.27	3.53	2.61
5.0	2.51	1.41	2.84	1.61	2.99	1.85	3.20	2.08	3.42	2.27	3.53	2.61
10.0	2.51	1.41	2.84	1.61	2.99	1.85	3.20	2.08	3.42	2.27	3.53	2.61
15.0	2.51	1.41	2.84	1.61	2.99	1.85	3.20	2.08	3.42	2.27	3.53	2.61
20.0	2.51	1.41	2.84	1.61	2.99	1.85	3.20	2.08	3.42	2.27	3.53	2.61
25.0	2.51	1.41	2.84	1.61	2.99	1.85	3.20	2.08	3.42	2.27	3.53	2.61
30.0	2.51	1.41	2.84	1.61	2.99	1.85	3.20	2.08	3.42	2.27	3.53	2.61
35.0	2.51	1.41	2.84	1.61	2.99	1.85	3.20	2.08	3.42	2.27	3.53	2.61
40.0	1.97	0.87	2.23	1.00	2.35	1.15	2.52	1.29	2.69	1.41	2.78	1.61
46.0	1.44	0.46	1.63	0.53	1.72	0.61	1.84	0.69	1.96	0.75	2.02	0.86

Models: ASEG12KETF and ASEG12KETF-B

Outdoor temperature	Indoor temperature (°CDB / °CWB)											
	18.0 / 12.0		21.0 / 15.0		23.0 / 16.0		27.0 / 19.0		29.0 / 21.0		32.0 / 23.0	
(°CDB)	TC	SHC	TC	SHC	TC	SHC	TC	SHC	TC	SHC	TC	SHC
-10.0	2.87	1.61	3.24	1.84	3.42	2.12	3.66	2.38	3.91	2.60	4.03	2.98
0.0	2.87	1.61	3.24	1.84	3.42	2.12	3.66	2.38	3.91	2.60	4.03	2.98
5.0	2.87	1.61	3.24	1.84	3.42	2.12	3.66	2.38	3.91	2.60	4.03	2.98
10.0	2.87	1.61	3.24	1.84	3.42	2.12	3.66	2.38	3.91	2.60	4.03	2.98
15.0	2.87	1.61	3.24	1.84	3.42	2.12	3.66	2.38	3.91	2.60	4.03	2.98
20.0	2.87	1.61	3.24	1.84	3.42	2.12	3.66	2.38	3.91	2.60	4.03	2.98
25.0	2.87	1.61	3.24	1.84	3.42	2.12	3.66	2.38	3.91	2.60	4.03	2.98
30.0	2.87	1.61	3.24	1.84	3.42	2.12	3.66	2.38	3.91	2.60	4.03	2.98
35.0	2.87	1.61	3.24	1.84	3.42	2.12	3.66	2.38	3.91	2.60	4.03	2.98
40.0	2.26	1.00	2.55	1.14	2.69	1.31	2.88	1.47	3.08	1.61	3.17	1.85
46.0	1.65	0.53	1.86	0.61	1.96	0.70	2.10	0.78	2.25	0.86	2.31	0.98

Models: ASEG14KETF and ASEG14KETF-B

Outdoor temperature	Indoor temperature (°CDB / °CWB)											
	18.0 / 12.0		21.0 / 15.0		23.0 / 16.0		27.0 / 19.0		29.0 / 21.0		32.0 / 23.0	
(°CDB)	TC	SHC	TC	SHC	TC	SHC	TC	SHC	TC	SHC	TC	SHC
-10.0	3.03	1.71	3.43	1.94	3.61	2.24	3.87	2.52	4.14	2.75	4.26	3.15
0.0	3.03	1.71	3.43	1.94	3.61	2.24	3.87	2.52	4.14	2.75	4.26	3.15
5.0	3.03	1.71	3.43	1.94	3.61	2.24	3.87	2.52	4.14	2.75	4.26	3.15
10.0	3.03	1.71	3.43	1.94	3.61	2.24	3.87	2.52	4.14	2.75	4.26	3.15
15.0	3.03	1.71	3.43	1.94	3.61	2.24	3.87	2.52	4.14	2.75	4.26	3.15
20.0	3.03	1.71	3.43	1.94	3.61	2.24	3.87	2.52	4.14	2.75	4.26	3.15
25.0	3.03	1.71	3.43	1.94	3.61	2.24	3.87	2.52	4.14	2.75	4.26	3.15
30.0	3.03	1.71	3.43	1.94	3.61	2.24	3.87	2.52	4.14	2.75	4.26	3.15
35.0	3.03	1.71	3.43	1.94	3.61	2.24	3.87	2.52	4.14	2.75	4.26	3.15
40.0	2.39	1.06	2.70	1.20	2.84	1.39	3.05	1.56	3.26	1.70	3.36	1.95
46.0	1.74	0.56	1.97	0.64	2.07	0.74	2.22	0.83	2.37	0.91	2.45	1.04

Model: ASEH07KGTG

Outdoor temperature	Indoor temperature (°CDB / °CWB)											
	18.0 / 12.0		21.0 / 15.0		23.0 / 16.0		27.0 / 19.0		29.0 / 21.0		32.0 / 23.0	
(°CDB)	TC	SHC	TC	SHC	TC	SHC	TC	SHC	TC	SHC	TC	SHC
-10.0	1.96	1.10	2.22	1.26	2.34	1.45	2.50	1.63	2.67	1.78	2.76	2.04
0.0	1.96	1.10	2.22	1.26	2.34	1.45	2.50	1.63	2.67	1.78	2.76	2.04
5.0	1.96	1.10	2.22	1.26	2.34	1.45	2.50	1.63	2.67	1.78	2.76	2.04
10.0	1.96	1.10	2.22	1.26	2.34	1.45	2.50	1.63	2.67	1.78	2.76	2.04
15.0	1.96	1.10	2.22	1.26	2.34	1.45	2.50	1.63	2.67	1.78	2.76	2.04
20.0	1.96	1.10	2.22	1.26	2.34	1.45	2.50	1.63	2.67	1.78	2.76	2.04
25.0	1.96	1.10	2.22	1.26	2.34	1.45	2.50	1.63	2.67	1.78	2.76	2.04
30.0	1.96	1.10	2.22	1.26	2.34	1.45	2.50	1.63	2.67	1.78	2.76	2.04
35.0	1.96	1.10	2.22	1.26	2.34	1.45	2.50	1.63	2.67	1.78	2.76	2.04
40.0	1.54	0.68	1.74	0.78	1.84	0.90	1.97	1.01	2.10	1.10	2.17	1.26
46.0	1.12	0.36	1.27	0.41	1.34	0.48	1.43	0.54	1.53	0.59	1.58	0.67

Model: ASEH09KGTG

Outdoor temperature	Indoor temperature (°CDB / °CWB)											
	18.0 / 12.0		21.0 / 15.0		23.0 / 16.0		27.0 / 19.0		29.0 / 21.0		32.0 / 23.0	
(°CDB)	TC	SHC	TC	SHC	TC	SHC	TC	SHC	TC	SHC	TC	SHC
-10.0	2.51	1.41	2.84	1.61	2.99	1.85	3.20	2.08	3.42	2.27	3.53	2.61
0.0	2.51	1.41	2.84	1.61	2.99	1.85	3.20	2.08	3.42	2.27	3.53	2.61
5.0	2.51	1.41	2.84	1.61	2.99	1.85	3.20	2.08	3.42	2.27	3.53	2.61
10.0	2.51	1.41	2.84	1.61	2.99	1.85	3.20	2.08	3.42	2.27	3.53	2.61
15.0	2.51	1.41	2.84	1.61	2.99	1.85	3.20	2.08	3.42	2.27	3.53	2.61
20.0	2.51	1.41	2.84	1.61	2.99	1.85	3.20	2.08	3.42	2.27	3.53	2.61
25.0	2.51	1.41	2.84	1.61	2.99	1.85	3.20	2.08	3.42	2.27	3.53	2.61
30.0	2.51	1.41	2.84	1.61	2.99	1.85	3.20	2.08	3.42	2.27	3.53	2.61
35.0	2.51	1.41	2.84	1.61	2.99	1.85	3.20	2.08	3.42	2.27	3.53	2.61
40.0	1.97	0.87	2.23	1.00	2.35	1.15	2.52	1.29	2.69	1.41	2.78	1.61
46.0	1.44	0.46	1.63	0.53	1.72	0.61	1.84	0.69	1.96	0.75	2.02	0.86

Model: ASEH12KGTG

Outdoor temperature	Indoor temperature (°CDB / °CWB)											
	18.0 / 12.0		21.0 / 15.0		23.0 / 16.0		27.0 / 19.0		29.0 / 21.0		32.0 / 23.0	
(°CDB)	TC	SHC	TC	SHC	TC	SHC	TC	SHC	TC	SHC	TC	SHC
-10.0	2.87	1.61	3.24	1.84	3.42	2.12	3.66	2.38	3.91	2.60	4.03	2.98
0.0	2.87	1.61	3.24	1.84	3.42	2.12	3.66	2.38	3.91	2.60	4.03	2.98
5.0	2.87	1.61	3.24	1.84	3.42	2.12	3.66	2.38	3.91	2.60	4.03	2.98
10.0	2.87	1.61	3.24	1.84	3.42	2.12	3.66	2.38	3.91	2.60	4.03	2.98
15.0	2.87	1.61	3.24	1.84	3.42	2.12	3.66	2.38	3.91	2.60	4.03	2.98
20.0	2.87	1.61	3.24	1.84	3.42	2.12	3.66	2.38	3.91	2.60	4.03	2.98
25.0	2.87	1.61	3.24	1.84	3.42	2.12	3.66	2.38	3.91	2.60	4.03	2.98
30.0	2.87	1.61	3.24	1.84	3.42	2.12	3.66	2.38	3.91	2.60	4.03	2.98
35.0	2.87	1.61	3.24	1.84	3.42	2.12	3.66	2.38	3.91	2.60	4.03	2.98
40.0	2.26	1.00	2.55	1.14	2.69	1.31	2.88	1.47	3.08	1.61	3.17	1.85
46.0	1.65	0.53	1.86	0.61	1.96	0.70	2.10	0.78	2.25	0.86	2.31	0.98

Model: ASEH14KGTG

Outdoor temperature	Indoor temperature (°CDB / °CWB)											
	18.0 / 12.0		21.0 / 15.0		23.0 / 16.0		27.0 / 19.0		29.0 / 21.0		32.0 / 23.0	
(°CDB)	TC	SHC	TC	SHC	TC	SHC	TC	SHC	TC	SHC	TC	SHC
-10.0	3.03	1.71	3.43	1.94	3.61	2.24	3.87	2.52	4.14	2.75	4.26	3.15
0.0	3.03	1.71	3.43	1.94	3.61	2.24	3.87	2.52	4.14	2.75	4.26	3.15
5.0	3.03	1.71	3.43	1.94	3.61	2.24	3.87	2.52	4.14	2.75	4.26	3.15
10.0	3.03	1.71	3.43	1.94	3.61	2.24	3.87	2.52	4.14	2.75	4.26	3.15
15.0	3.03	1.71	3.43	1.94	3.61	2.24	3.87	2.52	4.14	2.75	4.26	3.15
20.0	3.03	1.71	3.43	1.94	3.61	2.24	3.87	2.52	4.14	2.75	4.26	3.15
25.0	3.03	1.71	3.43	1.94	3.61	2.24	3.87	2.52	4.14	2.75	4.26	3.15
30.0	3.03	1.71	3.43	1.94	3.61	2.24	3.87	2.52	4.14	2.75	4.26	3.15
35.0	3.03	1.71	3.43	1.94	3.61	2.24	3.87	2.52	4.14	2.75	4.26	3.15
40.0	2.39	1.06	2.70	1.20	2.84	1.39	3.05	1.56	3.26	1.70	3.36	1.95
46.0	1.74	0.56	1.97	0.64	2.07	0.74	2.22	0.83	2.37	0.91	2.45	1.04

Model: ASEH05KNCA

Outdoor temperature	Indoor temperature (°CDB / °CWB)											
	18.0 / 12.0		21.0 / 15.0		23.0 / 16.0		27.0 / 19.0		29.0 / 21.0		32.0 / 23.0	
(°CDB)	TC	SHC	TC	SHC	TC	SHC	TC	SHC	TC	SHC	TC	SHC
-10.0	1.41	0.79	1.59	0.90	1.68	1.04	1.80	1.17	1.92	1.28	1.98	1.47
-5.0	1.41	0.79	1.59	0.90	1.68	1.04	1.80	1.17	1.92	1.28	1.98	1.47
0.0	1.41	0.79	1.59	0.90	1.68	1.04	1.80	1.17	1.92	1.28	1.98	1.47
5.0	1.41	0.79	1.59	0.90	1.68	1.04	1.80	1.17	1.92	1.28	1.98	1.47
10.0	1.41	0.79	1.59	0.90	1.68	1.04	1.80	1.17	1.92	1.28	1.98	1.47
15.0	1.41	0.79	1.59	0.90	1.68	1.04	1.80	1.17	1.92	1.28	1.98	1.47
20.0	1.41	0.79	1.59	0.90	1.68	1.04	1.80	1.17	1.92	1.28	1.98	1.47
25.0	1.41	0.79	1.59	0.90	1.68	1.04	1.80	1.17	1.92	1.28	1.98	1.47
30.0	1.41	0.79	1.59	0.90	1.68	1.04	1.80	1.17	1.92	1.28	1.98	1.47
35.0	1.41	0.79	1.59	0.90	1.68	1.04	1.80	1.17	1.92	1.28	1.98	1.47
40.0	1.11	0.49	1.26	0.56	1.32	0.64	1.42	0.72	1.51	0.79	1.56	0.91
46.0	0.81	0.26	0.92	0.30	0.96	0.34	1.03	0.39	1.10	0.42	1.14	0.48

Model: ASEH07KNCA

Outdoor temperature	Indoor temperature (°CDB / °CWB)											
	18.0 / 12.0		21.0 / 15.0		23.0 / 16.0		27.0 / 19.0		29.0 / 21.0		32.0 / 23.0	
(°CDB)	TC	SHC	TC	SHC	TC	SHC	TC	SHC	TC	SHC	TC	SHC
-10.0	1.96	1.10	2.22	1.26	2.34	1.45	2.50	1.63	2.67	1.78	2.76	2.04
-5.0	1.96	1.10	2.22	1.26	2.34	1.45	2.50	1.63	2.67	1.78	2.76	2.04
0.0	1.96	1.10	2.22	1.26	2.34	1.45	2.50	1.63	2.67	1.78	2.76	2.04
5.0	1.96	1.10	2.22	1.26	2.34	1.45	2.50	1.63	2.67	1.78	2.76	2.04
10.0	1.96	1.10	2.22	1.26	2.34	1.45	2.50	1.63	2.67	1.78	2.76	2.04
15.0	1.96	1.10	2.22	1.26	2.34	1.45	2.50	1.63	2.67	1.78	2.76	2.04
20.0	1.96	1.10	2.22	1.26	2.34	1.45	2.50	1.63	2.67	1.78	2.76	2.04
25.0	1.96	1.10	2.22	1.26	2.34	1.45	2.50	1.63	2.67	1.78	2.76	2.04
30.0	1.96	1.10	2.22	1.26	2.34	1.45	2.50	1.63	2.67	1.78	2.76	2.04
35.0	1.96	1.10	2.22	1.26	2.34	1.45	2.50	1.63	2.67	1.78	2.76	2.04
40.0	1.54	0.68	1.74	0.78	1.84	0.90	1.97	1.01	2.10	1.10	2.17	1.26
46.0	1.12	0.36	1.27	0.41	1.34	0.48	1.43	0.54	1.53	0.59	1.58	0.67

Model: ASEH09KNCA

Outdoor temperature	Indoor temperature (°CDB / °CWB)											
	18.0 / 12.0		21.0 / 15.0		23.0 / 16.0		27.0 / 19.0		29.0 / 21.0		32.0 / 23.0	
(°CDB)	TC	SHC	TC	SHC	TC	SHC	TC	SHC	TC	SHC	TC	SHC
-10.0	2.51	1.41	2.84	1.61	2.99	1.85	3.20	2.08	3.42	2.27	3.53	2.61
-5.0	2.51	1.41	2.84	1.61	2.99	1.85	3.20	2.08	3.42	2.27	3.53	2.61
0.0	2.51	1.41	2.84	1.61	2.99	1.85	3.20	2.08	3.42	2.27	3.53	2.61
5.0	2.51	1.41	2.84	1.61	2.99	1.85	3.20	2.08	3.42	2.27	3.53	2.61
10.0	2.51	1.41	2.84	1.61	2.99	1.85	3.20	2.08	3.42	2.27	3.53	2.61
15.0	2.51	1.41	2.84	1.61	2.99	1.85	3.20	2.08	3.42	2.27	3.53	2.61
20.0	2.51	1.41	2.84	1.61	2.99	1.85	3.20	2.08	3.42	2.27	3.53	2.61
25.0	2.51	1.41	2.84	1.61	2.99	1.85	3.20	2.08	3.42	2.27	3.53	2.61
30.0	2.51	1.41	2.84	1.61	2.99	1.85	3.20	2.08	3.42	2.27	3.53	2.61
35.0	2.51	1.41	2.84	1.61	2.99	1.85	3.20	2.08	3.42	2.27	3.53	2.61
40.0	1.97	0.87	2.23	1.00	2.35	1.15	2.52	1.29	2.69	1.41	2.78	1.61
46.0	1.44	0.46	1.63	0.53	1.72	0.61	1.84	0.69	1.96	0.75	2.02	0.86

Model: ASEH12KNCA

Outdoor temperature	Indoor temperature (°CDB / °CWB)											
	18.0 / 12.0		21.0 / 15.0		23.0 / 16.0		27.0 / 19.0		29.0 / 21.0		32.0 / 23.0	
(°CDB)	TC	SHC	TC	SHC	TC	SHC	TC	SHC	TC	SHC	TC	SHC
-10.0	2.82	1.59	3.19	1.81	3.36	2.08	3.60	2.34	3.85	2.56	3.97	2.93
-5.0	2.82	1.59	3.19	1.81	3.36	2.08	3.60	2.34	3.85	2.56	3.97	2.93
0.0	2.82	1.59	3.19	1.81	3.36	2.08	3.60	2.34	3.85	2.56	3.97	2.93
5.0	2.82	1.59	3.19	1.81	3.36	2.08	3.60	2.34	3.85	2.56	3.97	2.93
10.0	2.82	1.59	3.19	1.81	3.36	2.08	3.60	2.34	3.85	2.56	3.97	2.93
15.0	2.82	1.59	3.19	1.81	3.36	2.08	3.60	2.34	3.85	2.56	3.97	2.93
20.0	2.82	1.59	3.19	1.81	3.36	2.08	3.60	2.34	3.85	2.56	3.97	2.93
25.0	2.82	1.59	3.19	1.81	3.36	2.08	3.60	2.34	3.85	2.56	3.97	2.93
30.0	2.82	1.59	3.19	1.81	3.36	2.08	3.60	2.34	3.85	2.56	3.97	2.93
35.0	2.82	1.59	3.19	1.81	3.36	2.08	3.60	2.34	3.85	2.56	3.97	2.93
40.0	2.22	0.98	2.51	1.12	2.65	1.29	2.83	1.45	3.03	1.59	3.12	1.82
46.0	1.62	0.52	1.83	0.60	1.93	0.69	2.07	0.77	2.21	0.84	2.28	0.97

NOTES:

- TC: Total Capacity (kW), SHC: Sensible Heat Capacity (kW)
- Values mentioned in the table are based on the following conditions:
 - Pipe length: 5 m, Height difference: 0 m (Outdoor unit—Indoor unit)

● Floor type

Model: AGE09KVCA

Outdoor temperature	Indoor temperature (°CDB / °CWB)											
	18.0 / 12.0		21.0 / 15.0		23.0 / 16.0		27.0 / 19.0		29.0 / 21.0		32.0 / 23.0	
(°CDB)	TC	SHC	TC	SHC	TC	SHC	TC	SHC	TC	SHC	TC	SHC
-10.0	2.51	1.71	2.84	1.95	2.99	2.25	3.20	2.53	3.42	2.76	3.53	3.17
-5.0	2.51	1.71	2.84	1.95	2.99	2.25	3.20	2.53	3.42	2.76	3.53	3.17
0.0	2.51	1.71	2.84	1.95	2.99	2.25	3.20	2.53	3.42	2.76	3.53	3.17
5.0	2.51	1.71	2.84	1.95	2.99	2.25	3.20	2.53	3.42	2.76	3.53	3.17
10.0	2.51	1.71	2.84	1.95	2.99	2.25	3.20	2.53	3.42	2.76	3.53	3.17
15.0	2.51	1.71	2.84	1.95	2.99	2.25	3.20	2.53	3.42	2.76	3.53	3.17
20.0	2.51	1.71	2.84	1.95	2.99	2.25	3.20	2.53	3.42	2.76	3.53	3.17
25.0	2.51	1.71	2.84	1.95	2.99	2.25	3.20	2.53	3.42	2.76	3.53	3.17
30.0	2.51	1.71	2.84	1.95	2.99	2.25	3.20	2.53	3.42	2.76	3.53	3.17
35.0	2.51	1.71	2.84	1.95	2.99	2.25	3.20	2.53	3.42	2.76	3.53	3.17
40.0	2.37	1.53	2.68	1.75	2.83	2.01	3.03	2.26	3.24	2.48	3.34	2.84
46.0	2.24	1.37	2.53	1.56	2.67	1.79	2.86	2.01	3.05	2.20	3.15	2.52

Model: AGE12KVCA

Outdoor temperature	Indoor temperature (°CDB / °CWB)											
	18.0 / 12.0		21.0 / 15.0		23.0 / 16.0		27.0 / 19.0		29.0 / 21.0		32.0 / 23.0	
(°CDB)	TC	SHC	TC	SHC	TC	SHC	TC	SHC	TC	SHC	TC	SHC
-10.0	2.87	1.84	3.24	2.09	3.42	2.41	3.66	2.71	3.91	2.96	4.03	3.39
-5.0	2.87	1.84	3.24	2.09	3.42	2.41	3.66	2.71	3.91	2.96	4.03	3.39
0.0	2.87	1.84	3.24	2.09	3.42	2.41	3.66	2.71	3.91	2.96	4.03	3.39
5.0	2.87	1.84	3.24	2.09	3.42	2.41	3.66	2.71	3.91	2.96	4.03	3.39
10.0	2.87	1.84	3.24	2.09	3.42	2.41	3.66	2.71	3.91	2.96	4.03	3.39
15.0	2.87	1.84	3.24	2.09	3.42	2.41	3.66	2.71	3.91	2.96	4.03	3.39
20.0	2.87	1.84	3.24	2.09	3.42	2.41	3.66	2.71	3.91	2.96	4.03	3.39
25.0	2.87	1.84	3.24	2.09	3.42	2.41	3.66	2.71	3.91	2.96	4.03	3.39
30.0	2.87	1.84	3.24	2.09	3.42	2.41	3.66	2.71	3.91	2.96	4.03	3.39
35.0	2.87	1.84	3.24	2.09	3.42	2.41	3.66	2.71	3.91	2.96	4.03	3.39
40.0	2.72	1.64	3.07	1.87	3.23	2.16	3.46	2.42	3.70	2.65	3.82	3.04
46.0	2.56	1.46	2.89	1.67	3.05	1.92	3.27	2.16	3.49	2.36	3.60	2.70

Model: AGE14KVCA

Outdoor temperature	Indoor temperature (°CDB / °CWB)											
	18.0 / 12.0		21.0 / 15.0		23.0 / 16.0		27.0 / 19.0		29.0 / 21.0		32.0 / 23.0	
(°CDB)	TC	SHC	TC	SHC	TC	SHC	TC	SHC	TC	SHC	TC	SHC
-10.0	3.03	1.89	3.43	2.15	3.61	2.48	3.87	2.79	4.14	3.05	4.26	3.49
-5.0	3.03	1.89	3.43	2.15	3.61	2.48	3.87	2.79	4.14	3.05	4.26	3.49
0.0	3.03	1.89	3.43	2.15	3.61	2.48	3.87	2.79	4.14	3.05	4.26	3.49
5.0	3.03	1.89	3.43	2.15	3.61	2.48	3.87	2.79	4.14	3.05	4.26	3.49
10.0	3.03	1.89	3.43	2.15	3.61	2.48	3.87	2.79	4.14	3.05	4.26	3.49
15.0	3.03	1.89	3.43	2.15	3.61	2.48	3.87	2.79	4.14	3.05	4.26	3.49
20.0	3.03	1.89	3.43	2.15	3.61	2.48	3.87	2.79	4.14	3.05	4.26	3.49
25.0	3.03	1.89	3.43	2.15	3.61	2.48	3.87	2.79	4.14	3.05	4.26	3.49
30.0	3.03	1.89	3.43	2.15	3.61	2.48	3.87	2.79	4.14	3.05	4.26	3.49
35.0	3.03	1.89	3.43	2.15	3.61	2.48	3.87	2.79	4.14	3.05	4.26	3.49
40.0	2.87	1.69	3.24	1.93	3.42	2.22	3.66	2.49	3.91	2.73	4.04	3.13
46.0	2.71	1.50	3.06	1.72	3.23	1.97	3.45	2.22	3.69	2.43	3.81	2.78

NOTES:

- TC: Total Capacity (kW), SHC: Sensible Heat Capacity (kW)
- Values mentioned in the table are based on the following conditions:
 - Pipe length: 5 m, Height difference: 0 m (Outdoor unit—Indoor unit)

6-3. Heating capacity

NOTE: Values mentioned in the table are calculated based on the maximum capacity.

Model: AOEG14KBCA2

Indoor unit connecting capacity	Outdoor temperature		Indoor temperature									
			16.0 °CDB		18.0 °CDB		20.0 °CDB		22.0 °CDB		24.0 °CDB	
kBtu/h	°CDB	°CWB	TC	IP	TC	IP	TC	IP	TC	IP	TC	IP
21	-15.0	-16.0	3.30	1.34	3.30	1.37	3.20	1.40	3.10	1.43	3.00	1.46
	-10.0	-11.0	3.80	1.39	3.70	1.42	3.60	1.45	3.50	1.48	3.40	1.51
	-5.0	-7.0	4.20	1.44	4.10	1.47	4.00	1.50	3.90	1.53	3.80	1.56
	0.0	-2.0	5.30	1.46	5.20	1.49	5.10	1.52	4.90	1.55	4.80	1.58
	5.0	3.0	5.70	1.47	5.60	1.50	5.50	1.53	5.30	1.56	5.20	1.59
	7.0	6.0	5.80	1.63	5.60	1.67	5.50	1.70	5.40	1.73	5.20	1.77
	10.0	8.0	5.80	1.32	5.60	1.34	5.50	1.37	5.40	1.40	5.20	1.43
	15.0	10.0	5.80	1.20	5.60	1.23	5.50	1.25	5.40	1.28	5.20	1.30
	20.0	15.0	5.80	0.94	5.60	0.96	5.50	0.98	5.40	1.00	5.20	1.02
24.0	18.0	5.80	0.84	5.60	0.86	5.50	0.88	5.40	0.89	5.20	0.91	
19	-15.0	-16.0	3.30	1.34	3.30	1.37	3.20	1.40	3.10	1.43	3.00	1.46
	-10.0	-11.0	3.80	1.39	3.70	1.42	3.60	1.45	3.50	1.48	3.40	1.51
	-5.0	-7.0	4.20	1.44	4.10	1.47	4.00	1.50	3.90	1.53	3.80	1.56
	0.0	-2.0	5.30	1.46	5.20	1.49	5.10	1.52	4.90	1.55	4.80	1.58
	5.0	3.0	5.70	1.47	5.60	1.50	5.50	1.53	5.30	1.56	5.20	1.59
	7.0	6.0	5.80	1.63	5.60	1.67	5.50	1.70	5.40	1.73	5.20	1.77
	10.0	8.0	5.80	1.32	5.60	1.34	5.50	1.37	5.40	1.40	5.20	1.43
	15.0	10.0	5.80	1.20	5.60	1.23	5.50	1.25	5.40	1.28	5.20	1.30
	20.0	15.0	5.80	0.94	5.60	0.96	5.50	0.98	5.40	1.00	5.20	1.02
24.0	18.0	5.80	0.84	5.60	0.86	5.50	0.88	5.40	0.89	5.20	0.91	
18	-15.0	-16.0	3.30	1.34	3.30	1.37	3.20	1.40	3.10	1.43	3.00	1.46
	-10.0	-11.0	3.80	1.39	3.70	1.42	3.60	1.45	3.50	1.48	3.40	1.51
	-5.0	-7.0	4.20	1.44	4.10	1.47	4.00	1.50	3.90	1.53	3.80	1.56
	0.0	-2.0	5.30	1.46	5.20	1.49	5.10	1.52	4.90	1.55	4.80	1.58
	5.0	3.0	5.70	1.47	5.60	1.50	5.50	1.53	5.30	1.56	5.20	1.59
	7.0	6.0	5.80	1.63	5.60	1.67	5.50	1.70	5.40	1.73	5.20	1.77
	10.0	8.0	5.80	1.32	5.60	1.34	5.50	1.37	5.40	1.40	5.20	1.43
	15.0	10.0	5.80	1.20	5.60	1.23	5.50	1.25	5.40	1.28	5.20	1.30
	20.0	15.0	5.80	0.94	5.60	0.96	5.50	0.98	5.40	1.00	5.20	1.02
24.0	18.0	5.80	0.84	5.60	0.86	5.50	0.88	5.40	0.89	5.20	0.91	
17	-15.0	-16.0	3.34	1.34	3.26	1.37	3.18	1.40	3.10	1.43	3.02	1.46
	-10.0	-11.0	3.77	1.39	3.68	1.42	3.59	1.45	3.50	1.48	3.41	1.51
	-5.0	-7.0	4.19	1.44	4.09	1.47	4.00	1.50	3.90	1.53	3.80	1.56
	0.0	-2.0	5.32	1.46	5.20	1.49	5.07	1.52	4.94	1.55	4.82	1.58
	5.0	3.0	5.74	1.47	5.60	1.50	5.47	1.53	5.33	1.56	5.19	1.59
	7.0	6.0	5.78	1.63	5.64	1.67	5.50	1.70	5.36	1.73	5.23	1.77
	10.0	8.0	5.78	1.32	5.64	1.34	5.50	1.37	5.36	1.40	5.23	1.43
	15.0	10.0	5.78	1.20	5.64	1.23	5.50	1.25	5.36	1.28	5.23	1.30
	20.0	15.0	5.78	0.94	5.64	0.96	5.50	0.98	5.36	1.00	5.23	1.02
24.0	18.0	5.78	0.84	5.64	0.86	5.50	0.88	5.36	0.89	5.23	0.91	
16	-15.0	-16.0	3.30	1.34	3.30	1.37	3.20	1.40	3.10	1.43	3.00	1.46
	-10.0	-11.0	3.80	1.39	3.70	1.42	3.60	1.45	3.50	1.48	3.40	1.51
	-5.0	-7.0	4.20	1.44	4.10	1.47	4.00	1.50	3.90	1.53	3.80	1.56
	0.0	-2.0	5.30	1.46	5.20	1.49	5.10	1.52	4.90	1.55	4.80	1.58
	5.0	3.0	5.70	1.47	5.60	1.50	5.50	1.53	5.30	1.56	5.20	1.59
	7.0	6.0	5.80	1.63	5.60	1.67	5.50	1.70	5.40	1.73	5.20	1.77
	10.0	8.0	5.80	1.32	5.60	1.34	5.50	1.37	5.40	1.40	5.20	1.43
	15.0	10.0	5.80	1.20	5.60	1.23	5.50	1.25	5.40	1.28	5.20	1.30
	20.0	15.0	5.80	0.94	5.60	0.96	5.50	0.98	5.40	1.00	5.20	1.02
24.0	18.0	5.80	0.84	5.60	0.86	5.50	0.88	5.40	0.89	5.20	0.91	
14	-15.0	-16.0	3.30	1.34	3.30	1.36	3.20	1.39	3.10	1.42	3.00	1.45
	-10.0	-11.0	3.80	1.39	3.70	1.42	3.60	1.45	3.50	1.47	3.40	1.50
	-5.0	-7.0	4.20	1.44	4.10	1.47	4.00	1.50	3.90	1.53	3.80	1.56
	0.0	-2.0	5.30	1.45	5.20	1.48	5.10	1.51	4.90	1.54	4.80	1.57
	5.0	3.0	5.70	1.46	5.60	1.49	5.50	1.52	5.30	1.55	5.20	1.58
	7.0	6.0	5.80	1.63	5.60	1.67	5.50	1.70	5.40	1.73	5.20	1.77
	10.0	8.0	5.80	1.32	5.60	1.34	5.50	1.37	5.40	1.40	5.20	1.43
	15.0	10.0	5.80	1.20	5.60	1.23	5.50	1.25	5.40	1.28	5.20	1.30
	20.0	15.0	5.80	0.94	5.60	0.96	5.50	0.98	5.40	1.00	5.20	1.02
24.0	18.0	5.80	0.84	5.60	0.86	5.50	0.88	5.40	0.89	5.20	0.91	
12	-15.0	-16.0	3.34	1.18	3.26	1.20	3.18	1.23	3.10	1.25	3.02	1.28
	-10.0	-11.0	3.77	1.22	3.68	1.25	3.59	1.28	3.50	1.30	3.41	1.33
	-5.0	-7.0	4.19	1.27	4.09	1.30	4.00	1.32	3.90	1.35	3.80	1.38
	0.0	-2.0	5.32	1.28	5.20	1.31	5.07	1.33	4.94	1.36	4.82	1.39
	5.0	3.0	5.74	1.29	5.60	1.32	5.47	1.34	5.33	1.37	5.19	1.40
	7.0	6.0	5.15	1.44	5.02	1.47	4.90	1.50	4.78	1.53	4.66	1.56
	10.0	8.0	5.78	1.16	5.64	1.19	5.50	1.21	5.36	1.23	5.23	1.26
	15.0	10.0	5.78	1.06	5.64	1.08	5.50	1.10	5.36	1.13	5.23	1.15
	20.0	15.0	5.78	0.83	5.64	0.85	5.50	0.86	5.36	0.88	5.23	0.90
24.0	18.0	5.78	0.74	5.64	0.76	5.50	0.77	5.36	0.79	5.23	0.80	
10	-15.0	-16.0	3.34	0.98	3.26	1.00	3.18	1.02	3.10	1.04	3.02	1.07
	-10.0	-11.0	3.77	1.02	3.68	1.04	3.59	1.06	3.50	1.08	3.41	1.11
	-5.0	-7.0	4.19	1.06	4.09	1.08	4.00	1.10	3.90	1.12	3.80	1.15
	0.0	-2.0	5.32	1.07	5.20	1.09	5.07	1.11	4.94	1.13	4.82	1.16
	5.0	3.0	5.74	1.08	5.60	1.10	5.47	1.12	5.33	1.14	5.19	1.16
	7.0	6.0	4.41	1.20	4.31	1.23	4.20	1.25	4.10	1.28	3.99	1.30
	10.0	8.0	5.78	0.97	5.64	0.99	5.50	1.01	5.36	1.03	5.23	1.05
	15.0	10.0	5.78	0.88	5.64	0.90	5.50	0.92	5.36	0.94	5.23	0.96
	20.0	15.0	5.78	0.69	5.64	0.70	5.50	0.72	5.36	0.73	5.23	0.75
24.0	18.0	5.78	0.62	5.64	0.63	5.50	0.64	5.36	0.66	5.23	0.67	

NOTES:

- TC: Total Capacity (kW), IP: Input Power (kW)
- Values mentioned in the table are based on the following conditions:
 - Power source of specifications: 230 V
 - Pipe length: 5 m, Height difference: 0 m (Outdoor unit—Indoor unit)
- 2 or more indoor units should be connected.
- The total ability of connected a indoor unit is from 10,000 Btu/h up to 21,000 Btu/h.
- Input in the table are calculated based on the maximum indoor unit input combinations.

● Compact cassette type

Model: AUXG07KVLA

Outdoor temperature		Indoor temperature (°CDB)				
		16.0	18.0	20.0	22.0	24.0
(°CDB)	(°CWB)	TC	TC	TC	TC	TC
-15.0	-16.0	1.67	1.63	1.59	1.55	1.51
-10.0	-11.0	1.88	1.84	1.79	1.75	1.70
-5.0	-7.0	2.10	2.05	2.00	1.95	1.90
0.0	-2.0	2.66	2.60	2.54	2.47	2.41
5.0	3.0	2.87	2.80	2.73	2.67	2.60
7.0	6.0	2.89	2.82	2.75	2.68	2.61
10.0	8.0	2.89	2.82	2.75	2.68	2.61
15.0	10.0	2.89	2.82	2.75	2.68	2.61
20.0	15.0	2.89	2.82	2.75	2.68	2.61
24.0	18.0	2.89	2.82	2.75	2.68	2.61

Model: AUXG09KVLA

Outdoor temperature		Indoor temperature (°CDB)				
		16.0	18.0	20.0	22.0	24.0
(°CDB)	(°CWB)	TC	TC	TC	TC	TC
-15.0	-16.0	1.87	1.83	1.79	1.74	1.70
-10.0	-11.0	2.12	2.07	2.02	1.96	1.91
-5.0	-7.0	2.36	2.30	2.24	2.19	2.13
0.0	-2.0	2.99	2.92	2.85	2.78	2.71
5.0	3.0	3.23	3.15	3.07	3.00	2.92
7.0	6.0	3.24	3.17	3.09	3.01	2.94
10.0	8.0	3.24	3.17	3.09	3.01	2.94
15.0	10.0	3.24	3.17	3.09	3.01	2.94
20.0	15.0	3.24	3.17	3.09	3.01	2.94
24.0	18.0	3.24	3.17	3.09	3.01	2.94

Model: AUXG12KVLA

Outdoor temperature		Indoor temperature (°CDB)				
		16.0	18.0	20.0	22.0	24.0
(°CDB)	(°CWB)	TC	TC	TC	TC	TC
-15.0	-16.0	2.11	2.06	2.01	1.95	1.90
-10.0	-11.0	2.38	2.32	2.26	2.21	2.15
-5.0	-7.0	2.65	2.58	2.52	2.46	2.39
0.0	-2.0	3.36	3.28	3.20	3.12	3.04
5.0	3.0	3.62	3.54	3.45	3.36	3.28
7.0	6.0	3.64	3.56	3.47	3.38	3.30
10.0	8.0	3.64	3.56	3.47	3.38	3.30
15.0	10.0	3.64	3.56	3.47	3.38	3.30
20.0	15.0	3.64	3.56	3.47	3.38	3.30
24.0	18.0	3.64	3.56	3.47	3.38	3.30

NOTES:

- TC: Total Capacity (kW)
- Values mentioned in the table are based on the following conditions:
 - Pipe length: 5 m, Height difference: 0 m (Outdoor unit—Indoor unit)

● Mini duct type

Model: ARXG07KSLAP

Outdoor temperature		Indoor temperature (°CDB)				
		16.0	18.0	20.0	22.0	24.0
(°CDB)	(°CWB)	TC	TC	TC	TC	TC
-15.0	-16.0	1.67	1.63	1.59	1.55	1.51
-10.0	-11.0	1.88	1.84	1.79	1.75	1.70
-5.0	-7.0	2.10	2.05	2.00	1.95	1.90
0.0	-2.0	2.66	2.60	2.54	2.47	2.41
5.0	3.0	2.87	2.80	2.73	2.67	2.60
7.0	6.0	2.89	2.82	2.75	2.68	2.61
10.0	8.0	2.89	2.82	2.75	2.68	2.61
15.0	10.0	2.89	2.82	2.75	2.68	2.61
20.0	15.0	2.89	2.82	2.75	2.68	2.61
24.0	18.0	2.89	2.82	2.75	2.68	2.61

Model: ARXG09KSLAP

Outdoor temperature		Indoor temperature (°CDB)				
		16.0	18.0	20.0	22.0	24.0
(°CDB)	(°CWB)	TC	TC	TC	TC	TC
-15.0	-16.0	1.87	1.83	1.79	1.74	1.70
-10.0	-11.0	2.12	2.07	2.02	1.96	1.91
-5.0	-7.0	2.36	2.30	2.24	2.19	2.13
0.0	-2.0	2.99	2.92	2.85	2.78	2.71
5.0	3.0	3.23	3.15	3.07	3.00	2.92
7.0	6.0	3.24	3.17	3.09	3.01	2.94
10.0	8.0	3.24	3.17	3.09	3.01	2.94
15.0	10.0	3.24	3.17	3.09	3.01	2.94
20.0	15.0	3.24	3.17	3.09	3.01	2.94
24.0	18.0	3.24	3.17	3.09	3.01	2.94

Model: ARXG12KSLAP

Outdoor temperature		Indoor temperature (°CDB)				
		16.0	18.0	20.0	22.0	24.0
(°CDB)	(°CWB)	TC	TC	TC	TC	TC
-15.0	-16.0	2.11	2.06	2.01	1.95	1.90
-10.0	-11.0	2.38	2.32	2.26	2.21	2.15
-5.0	-7.0	2.65	2.58	2.52	2.46	2.39
0.0	-2.0	3.36	3.28	3.20	3.12	3.04
5.0	3.0	3.62	3.54	3.45	3.36	3.28
7.0	6.0	3.64	3.56	3.47	3.38	3.30
10.0	8.0	3.64	3.56	3.47	3.38	3.30
15.0	10.0	3.64	3.56	3.47	3.38	3.30
20.0	15.0	3.64	3.56	3.47	3.38	3.30
24.0	18.0	3.64	3.56	3.47	3.38	3.30

NOTES:

- TC: Total Capacity (kW)
- Values mentioned in the table are based on the following conditions:
 - Pipe length: 5 m, Height difference: 0 m [Outdoor unit—Indoor unit]

● Slim duct type

Model: ARXG07KLLAP

Outdoor temperature		Indoor temperature (°CDB)				
		16.0	18.0	20.0	22.0	24.0
(°CDB)	(°CWB)	TC	TC	TC	TC	TC
-15.0	-16.0	1.67	1.63	1.59	1.55	1.51
-10.0	-11.0	1.88	1.84	1.79	1.75	1.70
-5.0	-7.0	2.10	2.05	2.00	1.95	1.90
0.0	-2.0	2.66	2.60	2.54	2.47	2.41
5.0	3.0	2.87	2.80	2.73	2.67	2.60
7.0	6.0	2.89	2.82	2.75	2.68	2.61
10.0	8.0	2.89	2.82	2.75	2.68	2.61
15.0	10.0	2.89	2.82	2.75	2.68	2.61
20.0	15.0	2.89	2.82	2.75	2.68	2.61
24.0	18.0	2.89	2.82	2.75	2.68	2.61

Model: ARXG09KLLAP

Outdoor temperature		Indoor temperature (°CDB)				
		16.0	18.0	20.0	22.0	24.0
(°CDB)	(°CWB)	TC	TC	TC	TC	TC
-15.0	-16.0	1.87	1.83	1.79	1.74	1.70
-10.0	-11.0	2.12	2.07	2.02	1.96	1.91
-5.0	-7.0	2.36	2.30	2.24	2.19	2.13
0.0	-2.0	2.99	2.92	2.85	2.78	2.71
5.0	3.0	3.23	3.15	3.07	3.00	2.92
7.0	6.0	3.24	3.17	3.09	3.01	2.94
10.0	8.0	3.24	3.17	3.09	3.01	2.94
15.0	10.0	3.24	3.17	3.09	3.01	2.94
20.0	15.0	3.24	3.17	3.09	3.01	2.94
24.0	18.0	3.24	3.17	3.09	3.01	2.94

Model: ARXG12KLLAP

Outdoor temperature		Indoor temperature (°CDB)				
		16.0	18.0	20.0	22.0	24.0
(°CDB)	(°CWB)	TC	TC	TC	TC	TC
-15.0	-16.0	2.11	2.06	2.01	1.95	1.90
-10.0	-11.0	2.38	2.32	2.26	2.21	2.15
-5.0	-7.0	2.65	2.58	2.52	2.46	2.39
0.0	-2.0	3.36	3.28	3.20	3.12	3.04
5.0	3.0	3.62	3.54	3.45	3.36	3.28
7.0	6.0	3.64	3.56	3.47	3.38	3.30
10.0	8.0	3.64	3.56	3.47	3.38	3.30
15.0	10.0	3.64	3.56	3.47	3.38	3.30
20.0	15.0	3.64	3.56	3.47	3.38	3.30
24.0	18.0	3.64	3.56	3.47	3.38	3.30

NOTES:

- TC: Total Capacity (kW)
- Values mentioned in the table are based on the following conditions:
 - Pipe length: 5 m, Height difference: 0 m (Outdoor unit—Indoor unit)

● Medium static pressure duct type

Model: ARXH12KMTAP

Outdoor temperature		Indoor temperature (°CDB)				
(°CDB)	(°CWB)	16.0	18.0	20.0	22.0	24.0
		TC	TC	TC	TC	TC
-15.0	-16.0	2.11	2.06	2.01	1.95	1.90
-10.0	-11.0	2.38	2.32	2.26	2.21	2.15
-5.0	-7.0	2.65	2.58	2.52	2.46	2.39
0.0	-2.0	3.36	3.28	3.20	3.12	3.04
5.0	3.0	3.62	3.54	3.45	3.36	3.28
7.0	6.0	3.64	3.56	3.47	3.38	3.30
10.0	8.0	3.64	3.56	3.47	3.38	3.30
15.0	10.0	3.64	3.56	3.47	3.38	3.30
20.0	15.0	3.64	3.56	3.47	3.38	3.30
24.0	18.0	3.64	3.56	3.47	3.38	3.30

NOTES:

- TC: Total Capacity (kW)
- Values mentioned in the table are based on the following conditions:
 - Pipe length: 5 m, Height difference: 0 m (Outdoor unit—Indoor unit)

● Wall mounted type

Model: ASEH07KMCG, ASEH07KMCG-B

Outdoor temperature		Indoor temperature (°CDB)				
		16.0	18.0	20.0	22.0	24.0
(°CDB)	(°CWB)	TC	TC	TC	TC	TC
-15.0	-16.0	1.67	1.63	1.59	1.55	1.51
-10.0	-11.0	1.88	1.84	1.79	1.75	1.70
-5.0	-7.0	2.10	2.05	2.00	1.95	1.90
0.0	-2.0	2.66	2.60	2.54	2.47	2.41
5.0	3.0	2.87	2.80	2.73	2.67	2.60
7.0	6.0	2.89	2.82	2.75	2.68	2.61
10.0	8.0	2.89	2.82	2.75	2.68	2.61
15.0	10.0	2.89	2.82	2.75	2.68	2.61
20.0	15.0	2.89	2.82	2.75	2.68	2.61
24.0	18.0	2.89	2.82	2.75	2.68	2.61

Model: ASEH09KMCG, ASEH09KMCG-B

Outdoor temperature		Indoor temperature (°CDB)				
		16.0	18.0	20.0	22.0	24.0
(°CDB)	(°CWB)	TC	TC	TC	TC	TC
-15.0	-16.0	1.87	1.83	1.79	1.74	1.70
-10.0	-11.0	2.12	2.07	2.02	1.96	1.91
-5.0	-7.0	2.36	2.30	2.24	2.19	2.13
0.0	-2.0	2.99	2.92	2.85	2.78	2.71
5.0	3.0	3.23	3.15	3.07	3.00	2.92
7.0	6.0	3.24	3.17	3.09	3.01	2.94
10.0	8.0	3.24	3.17	3.09	3.01	2.94
15.0	10.0	3.24	3.17	3.09	3.01	2.94
20.0	15.0	3.24	3.17	3.09	3.01	2.94
24.0	18.0	3.24	3.17	3.09	3.01	2.94

Model: ASEH12KMCG, ASEH12KMCG-B

Outdoor temperature		Indoor temperature (°CDB)				
		16.0	18.0	20.0	22.0	24.0
(°CDB)	(°CWB)	TC	TC	TC	TC	TC
-15.0	-16.0	2.11	2.06	2.01	1.95	1.90
-10.0	-11.0	2.38	2.32	2.26	2.21	2.15
-5.0	-7.0	2.65	2.58	2.52	2.46	2.39
0.0	-2.0	3.36	3.28	3.20	3.12	3.04
5.0	3.0	3.62	3.54	3.45	3.36	3.28
7.0	6.0	3.64	3.56	3.47	3.38	3.30
10.0	8.0	3.64	3.56	3.47	3.38	3.30
15.0	10.0	3.64	3.56	3.47	3.38	3.30
20.0	15.0	3.64	3.56	3.47	3.38	3.30
24.0	18.0	3.64	3.56	3.47	3.38	3.30

Models: ASEG07KETF and ASEG07KETF-B

Outdoor temperature		Indoor temperature (°CDB)				
		16.0	18.0	20.0	22.0	24.0
(°CDB)	(°CWB)	TC	TC	TC	TC	TC
-15.0	-16.0	1.67	1.63	1.59	1.55	1.51
-10.0	-11.0	1.88	1.84	1.79	1.75	1.70
-5.0	-7.0	2.10	2.05	2.00	1.95	1.90
0.0	-2.0	2.66	2.60	2.54	2.47	2.41
5.0	3.0	2.87	2.80	2.73	2.67	2.60
7.0	6.0	2.89	2.82	2.75	2.68	2.61
10.0	8.0	2.89	2.82	2.75	2.68	2.61
15.0	10.0	2.89	2.82	2.75	2.68	2.61
20.0	15.0	2.89	2.82	2.75	2.68	2.61
24.0	18.0	2.89	2.82	2.75	2.68	2.61

Models: ASEG09KETF and ASEG09KETF-B

Outdoor temperature		Indoor temperature (°CDB)				
		16.0	18.0	20.0	22.0	24.0
(°CDB)	(°CWB)	TC	TC	TC	TC	TC
-15.0	-16.0	1.87	1.83	1.79	1.74	1.70
-10.0	-11.0	2.12	2.07	2.02	1.96	1.91
-5.0	-7.0	2.36	2.30	2.24	2.19	2.13
0.0	-2.0	2.99	2.92	2.85	2.78	2.71
5.0	3.0	3.23	3.15	3.07	3.00	2.92
7.0	6.0	3.24	3.17	3.09	3.01	2.94
10.0	8.0	3.24	3.17	3.09	3.01	2.94
15.0	10.0	3.24	3.17	3.09	3.01	2.94
20.0	15.0	3.24	3.17	3.09	3.01	2.94
24.0	18.0	3.24	3.17	3.09	3.01	2.94

Models: ASEG12KETF and ASEG12KETF-B

Outdoor temperature		Indoor temperature (°CDB)				
		16.0	18.0	20.0	22.0	24.0
(°CDB)	(°CWB)	TC	TC	TC	TC	TC
-15.0	-16.0	2.11	2.06	2.01	1.95	1.90
-10.0	-11.0	2.38	2.32	2.26	2.21	2.15
-5.0	-7.0	2.65	2.58	2.52	2.46	2.39
0.0	-2.0	3.36	3.28	3.20	3.12	3.04
5.0	3.0	3.62	3.54	3.45	3.36	3.28
7.0	6.0	3.64	3.56	3.47	3.38	3.30
10.0	8.0	3.64	3.56	3.47	3.38	3.30
15.0	10.0	3.64	3.56	3.47	3.38	3.30
20.0	15.0	3.64	3.56	3.47	3.38	3.30
24.0	18.0	3.64	3.56	3.47	3.38	3.30

Model: ASEH07KGTG

Outdoor temperature		Indoor temperature (°CDB)				
		16.0	18.0	20.0	22.0	24.0
(°CDB)	(°CWB)	TC	TC	TC	TC	TC
-15.0	-16.0	1.67	1.63	1.59	1.55	1.51
-10.0	-11.0	1.88	1.84	1.79	1.75	1.70
-5.0	-7.0	2.10	2.05	2.00	1.95	1.90
0.0	-2.0	2.66	2.60	2.54	2.47	2.41
5.0	3.0	2.87	2.80	2.73	2.67	2.60
7.0	6.0	2.89	2.82	2.75	2.68	2.61
10.0	8.0	2.89	2.82	2.75	2.68	2.61
15.0	10.0	2.89	2.82	2.75	2.68	2.61
20.0	15.0	2.89	2.82	2.75	2.68	2.61
24.0	18.0	2.89	2.82	2.75	2.68	2.61

Model: ASEH09KGTG

Outdoor temperature		Indoor temperature (°CDB)				
		16.0	18.0	20.0	22.0	24.0
(°CDB)	(°CWB)	TC	TC	TC	TC	TC
-15.0	-16.0	1.87	1.83	1.79	1.74	1.70
-10.0	-11.0	2.12	2.07	2.02	1.96	1.91
-5.0	-7.0	2.36	2.30	2.24	2.19	2.13
0.0	-2.0	2.99	2.92	2.85	2.78	2.71
5.0	3.0	3.23	3.15	3.07	3.00	2.92
7.0	6.0	3.24	3.17	3.09	3.01	2.94
10.0	8.0	3.24	3.17	3.09	3.01	2.94
15.0	10.0	3.24	3.17	3.09	3.01	2.94
20.0	15.0	3.24	3.17	3.09	3.01	2.94
24.0	18.0	3.24	3.17	3.09	3.01	2.94

Model: ASEH12KGTG

Outdoor temperature		Indoor temperature (°CDB)				
		16.0	18.0	20.0	22.0	24.0
(°CDB)	(°CWB)	TC	TC	TC	TC	TC
-15.0	-16.0	2.11	2.06	2.01	1.95	1.90
-10.0	-11.0	2.38	2.32	2.26	2.21	2.15
-5.0	-7.0	2.65	2.58	2.52	2.46	2.39
0.0	-2.0	3.36	3.28	3.20	3.12	3.04
5.0	3.0	3.62	3.54	3.45	3.36	3.28
7.0	6.0	3.64	3.56	3.47	3.38	3.30
10.0	8.0	3.64	3.56	3.47	3.38	3.30
15.0	10.0	3.64	3.56	3.47	3.38	3.30
20.0	15.0	3.64	3.56	3.47	3.38	3.30
24.0	18.0	3.64	3.56	3.47	3.38	3.30

Model: ASEH05KNCA

Outdoor temperature		Indoor temperature (°CDB)				
		16.0	18.0	20.0	22.0	24.0
(°CDB)	(°CWB)	TC	TC	TC	TC	TC
-15.0	-16.0	1.27	1.24	1.21	1.18	1.15
-10.0	-11.0	1.44	1.40	1.37	1.34	1.30
-5.0	-7.0	1.60	1.56	1.53	1.49	1.45
0.0	-2.0	2.03	1.98	1.94	1.89	1.84
5.0	3.0	2.19	2.14	2.09	2.04	1.98
7.0	6.0	2.21	2.15	2.10	2.05	2.00
10.0	8.0	2.21	2.15	2.10	2.05	2.00
15.0	10.0	2.21	2.15	2.10	2.05	2.00
20.0	15.0	2.21	2.15	2.10	2.05	2.00
24.0	18.0	2.21	2.15	2.10	2.05	2.00

Model: ASEH07KNCA

Outdoor temperature		Indoor temperature (°CDB)				
		16.0	18.0	20.0	22.0	24.0
(°CDB)	(°CWB)	TC	TC	TC	TC	TC
-15.0	-16.0	1.67	1.63	1.59	1.55	1.51
-10.0	-11.0	1.88	1.84	1.79	1.75	1.70
-5.0	-7.0	2.10	2.05	2.00	1.95	1.90
0.0	-2.0	2.66	2.60	2.54	2.47	2.41
5.0	3.0	2.87	2.80	2.73	2.67	2.60
7.0	6.0	2.89	2.82	2.75	2.68	2.61
10.0	8.0	2.89	2.82	2.75	2.68	2.61
15.0	10.0	2.89	2.82	2.75	2.68	2.61
20.0	15.0	2.89	2.82	2.75	2.68	2.61
24.0	18.0	2.89	2.82	2.75	2.68	2.61

Model: ASEH09KNCA

Outdoor temperature		Indoor temperature (°CDB)				
		16.0	18.0	20.0	22.0	24.0
(°CDB)	(°CWB)	TC	TC	TC	TC	TC
-15.0	-16.0	1.87	1.83	1.79	1.74	1.70
-10.0	-11.0	2.12	2.07	2.02	1.96	1.91
-5.0	-7.0	2.36	2.30	2.24	2.19	2.13
0.0	-2.0	2.99	2.92	2.85	2.78	2.71
5.0	3.0	3.23	3.15	3.07	3.00	2.92
7.0	6.0	3.24	3.17	3.09	3.01	2.94
10.0	8.0	3.24	3.17	3.09	3.01	2.94
15.0	10.0	3.24	3.17	3.09	3.01	2.94
20.0	15.0	3.24	3.17	3.09	3.01	2.94
24.0	18.0	3.24	3.17	3.09	3.01	2.94

Model: ASEH12KNCA

Outdoor temperature		Indoor temperature (°CDB)				
		16.0	18.0	20.0	22.0	24.0
(°CDB)	(°CWB)	TC	TC	TC	TC	TC
-15.0	-16.0	2.11	2.06	2.01	1.95	1.90
-10.0	-11.0	2.38	2.32	2.26	2.21	2.15
-5.0	-7.0	2.65	2.58	2.52	2.46	2.39
0.0	-2.0	3.36	3.28	3.20	3.12	3.04
5.0	3.0	3.62	3.54	3.45	3.36	3.28
7.0	6.0	3.64	3.56	3.47	3.38	3.30
10.0	8.0	3.64	3.56	3.47	3.38	3.30
15.0	10.0	3.64	3.56	3.47	3.38	3.30
20.0	15.0	3.64	3.56	3.47	3.38	3.30
24.0	18.0	3.64	3.56	3.47	3.38	3.30

NOTES:

- TC: Total Capacity (kW)
- Values mentioned in the table are based on the following conditions:
 - Pipe length: 5 m, Height difference: 0 m (Outdoor unit—Indoor unit)

● Floor type

Model: AGE09KVCA

Outdoor temperature		Indoor temperature (°CDB)				
		16.0	18.0	20.0	22.0	24.0
(°CDB)	(°CWB)	TC	TC	TC	TC	TC
-15.0	-16.0	1.87	1.83	1.79	1.74	1.70
-10.0	-11.0	2.12	2.07	2.02	1.96	1.91
-5.0	-7.0	2.36	2.30	2.24	2.19	2.13
0.0	-2.0	2.99	2.92	2.85	2.78	2.71
5.0	3.0	3.23	3.15	3.07	3.00	2.92
7.0	6.0	3.24	3.17	3.09	3.01	2.94
10.0	8.0	3.24	3.17	3.09	3.01	2.94
15.0	10.0	3.24	3.17	3.09	3.01	2.94
20.0	15.0	3.24	3.17	3.09	3.01	2.94
24.0	18.0	3.24	3.17	3.09	3.01	2.94

Model: AGE12KVCA

Outdoor temperature		Indoor temperature (°CDB)				
		16.0	18.0	20.0	22.0	24.0
(°CDB)	(°CWB)	TC	TC	TC	TC	TC
-15.0	-16.0	2.11	2.06	2.01	1.95	1.90
-10.0	-11.0	2.38	2.32	2.26	2.21	2.15
-5.0	-7.0	2.65	2.58	2.52	2.46	2.39
0.0	-2.0	3.36	3.28	3.20	3.12	3.04
5.0	3.0	3.62	3.54	3.45	3.36	3.28
7.0	6.0	3.64	3.56	3.47	3.38	3.30
10.0	8.0	3.64	3.56	3.47	3.38	3.30
15.0	10.0	3.64	3.56	3.47	3.38	3.30
20.0	15.0	3.64	3.56	3.47	3.38	3.30
24.0	18.0	3.64	3.56	3.47	3.38	3.30

NOTES:

- TC: Total Capacity (kW)
- Values mentioned in the table are based on the following conditions:
 - Pipe length: 5 m, Height difference: 0 m (Outdoor unit—Indoor unit)

Model: AOEG18KBCA2

Indoor unit connecting capacity	Outdoor temperature		Indoor temperature									
			16.0 °CDB		18.0 °CDB		20.0 °CDB		22.0 °CDB		24.0 °CDB	
kBtu/h	°CDB	°CWB	TC	IP	TC	IP	TC	IP	TC	IP	TC	IP
26	-15.0	-16.0	4.00	1.63	3.90	1.67	3.80	1.70	3.70	1.73	3.60	1.77
	-10.0	-11.0	4.60	1.68	4.40	1.72	4.30	1.75	4.20	1.79	4.10	1.82
	-5.0	-7.0	5.20	1.73	5.00	1.76	4.90	1.80	4.80	1.84	4.70	1.87
	0.0	-2.0	6.60	1.90	6.40	1.94	6.30	1.98	6.10	2.02	5.90	2.06
	5.0	3.0	7.40	1.90	7.20	1.94	7.00	1.98	6.80	2.02	6.70	2.06
	7.0	6.0	7.40	1.80	7.20	1.84	7.00	1.88	6.80	1.92	6.70	1.96
	10.0	8.0	7.40	1.69	7.20	1.73	7.00	1.77	6.80	1.80	6.70	1.84
	15.0	10.0	7.40	1.55	7.20	1.59	7.00	1.62	6.80	1.65	6.70	1.68
	20.0	15.0	7.40	1.31	7.20	1.34	7.00	1.37	6.80	1.40	6.70	1.42
24.0	18.0	7.40	1.15	7.20	1.18	7.00	1.20	6.80	1.23	6.70	1.25	
24	-15.0	-16.0	4.00	1.63	3.90	1.67	3.80	1.70	3.70	1.73	3.60	1.77
	-10.0	-11.0	4.60	1.68	4.40	1.72	4.30	1.75	4.20	1.79	4.10	1.82
	-5.0	-7.0	5.20	1.73	5.00	1.76	4.90	1.80	4.80	1.84	4.70	1.87
	0.0	-2.0	6.60	1.90	6.40	1.94	6.30	1.98	6.10	2.02	5.90	2.06
	5.0	3.0	7.40	1.90	7.20	1.94	7.00	1.98	6.80	2.02	6.70	2.06
	7.0	6.0	7.40	1.80	7.20	1.84	7.00	1.88	6.80	1.92	6.70	1.96
	10.0	8.0	7.40	1.69	7.20	1.73	7.00	1.77	6.80	1.80	6.70	1.84
	15.0	10.0	7.40	1.55	7.20	1.59	7.00	1.62	6.80	1.65	6.70	1.68
	20.0	15.0	7.40	1.31	7.20	1.34	7.00	1.37	6.80	1.40	6.70	1.42
24.0	18.0	7.40	1.15	7.20	1.18	7.00	1.20	6.80	1.23	6.70	1.25	
23	-15.0	-16.0	4.00	1.63	3.90	1.67	3.80	1.70	3.70	1.73	3.60	1.77
	-10.0	-11.0	4.60	1.68	4.40	1.72	4.30	1.75	4.20	1.79	4.10	1.82
	-5.0	-7.0	5.20	1.73	5.00	1.76	4.90	1.80	4.80	1.84	4.70	1.87
	0.0	-2.0	6.60	1.90	6.40	1.94	6.30	1.98	6.10	2.02	5.90	2.06
	5.0	3.0	7.40	1.90	7.20	1.94	7.00	1.98	6.80	2.02	6.70	2.06
	7.0	6.0	7.40	1.80	7.20	1.84	7.00	1.88	6.80	1.92	6.70	1.96
	10.0	8.0	7.40	1.69	7.20	1.73	7.00	1.77	6.80	1.80	6.70	1.84
	15.0	10.0	7.40	1.55	7.20	1.59	7.00	1.62	6.80	1.65	6.70	1.68
	20.0	15.0	7.40	1.31	7.20	1.34	7.00	1.37	6.80	1.40	6.70	1.42
24.0	18.0	7.40	1.15	7.20	1.18	7.00	1.20	6.80	1.23	6.70	1.25	
21	-15.0	-16.0	4.00	1.63	3.90	1.67	3.80	1.70	3.70	1.73	3.60	1.77
	-10.0	-11.0	4.60	1.68	4.40	1.72	4.30	1.75	4.20	1.79	4.10	1.82
	-5.0	-7.0	5.20	1.73	5.00	1.76	4.90	1.80	4.80	1.84	4.70	1.87
	0.0	-2.0	6.60	1.90	6.40	1.94	6.30	1.98	6.10	2.02	5.90	2.06
	5.0	3.0	7.40	1.90	7.20	1.94	7.00	1.98	6.80	2.02	6.70	2.06
	7.0	6.0	7.40	1.80	7.20	1.84	7.00	1.88	6.80	1.92	6.70	1.96
	10.0	8.0	7.40	1.69	7.20	1.73	7.00	1.77	6.80	1.80	6.70	1.84
	15.0	10.0	7.40	1.55	7.20	1.59	7.00	1.62	6.80	1.65	6.70	1.68
	20.0	15.0	7.40	1.31	7.20	1.34	7.00	1.37	6.80	1.40	6.70	1.42
24.0	18.0	7.40	1.15	7.20	1.18	7.00	1.20	6.80	1.23	6.70	1.25	
19	-15.0	-16.0	4.00	1.63	3.90	1.67	3.80	1.70	3.70	1.73	3.60	1.77
	-10.0	-11.0	4.60	1.68	4.40	1.72	4.30	1.75	4.20	1.79	4.10	1.82
	-5.0	-7.0	5.20	1.73	5.00	1.76	4.90	1.80	4.80	1.84	4.70	1.87
	0.0	-2.0	6.60	1.90	6.40	1.94	6.30	1.98	6.10	2.02	5.90	2.06
	5.0	3.0	7.40	1.90	7.20	1.94	7.00	1.98	6.80	2.02	6.70	2.06
	7.0	6.0	7.40	1.80	7.20	1.84	7.00	1.88	6.80	1.92	6.70	1.96
	10.0	8.0	7.40	1.69	7.20	1.73	7.00	1.77	6.80	1.80	6.70	1.84
	15.0	10.0	7.40	1.55	7.20	1.59	7.00	1.62	6.80	1.65	6.70	1.68
	20.0	15.0	7.40	1.31	7.20	1.34	7.00	1.37	6.80	1.40	6.70	1.42
24.0	18.0	7.40	1.15	7.20	1.18	7.00	1.20	6.80	1.23	6.70	1.25	
18	-15.0	-16.0	4.00	1.63	3.90	1.67	3.80	1.70	3.70	1.73	3.60	1.77
	-10.0	-11.0	4.60	1.68	4.40	1.72	4.30	1.75	4.20	1.79	4.10	1.82
	-5.0	-7.0	5.20	1.73	5.00	1.76	4.90	1.80	4.80	1.84	4.70	1.87
	0.0	-2.0	6.60	1.90	6.40	1.94	6.30	1.98	6.10	2.02	5.90	2.06
	5.0	3.0	7.40	1.90	7.20	1.94	7.00	1.98	6.80	2.02	6.70	2.06
	7.0	6.0	7.40	1.80	7.20	1.84	7.00	1.88	6.80	1.92	6.70	1.96
	10.0	8.0	7.40	1.69	7.20	1.73	7.00	1.77	6.80	1.80	6.70	1.84
	15.0	10.0	7.40	1.55	7.20	1.59	7.00	1.62	6.80	1.65	6.70	1.68
	20.0	15.0	7.40	1.31	7.20	1.34	7.00	1.37	6.80	1.40	6.70	1.42
24.0	18.0	7.40	1.15	7.20	1.18	7.00	1.20	6.80	1.23	6.70	1.25	
17	-15.0	-16.0	3.62	1.53	3.53	1.56	3.45	1.59	3.36	1.62	3.27	1.65
	-10.0	-11.0	4.16	1.57	4.07	1.61	3.97	1.64	3.87	1.67	3.77	1.71
	-5.0	-7.0	4.71	1.61	4.60	1.65	4.49	1.68	4.37	1.71	4.26	1.75
	0.0	-2.0	6.01	1.79	5.86	1.82	5.72	1.86	5.58	1.90	5.43	1.93
	5.0	3.0	6.72	1.79	6.56	1.82	6.40	1.86	6.24	1.90	6.08	1.93
	7.0	6.0	6.72	1.69	6.56	1.72	6.40	1.76	6.24	1.80	6.08	1.83
	10.0	8.0	6.72	1.59	6.56	1.62	6.40	1.65	6.24	1.69	6.08	1.72
	15.0	10.0	6.72	1.45	6.56	1.49	6.40	1.52	6.24	1.55	6.08	1.58
	20.0	15.0	6.72	1.23	6.56	1.26	6.40	1.28	6.24	1.31	6.08	1.33
24.0	18.0	6.72	1.08	6.56	1.10	6.40	1.12	6.24	1.15	6.08	1.17	
16	-15.0	-16.0	3.60	1.46	3.50	1.49	3.40	1.52	3.40	1.55	3.30	1.58
	-10.0	-11.0	4.20	1.50	4.10	1.53	4.00	1.56	3.90	1.59	3.80	1.62
	-5.0	-7.0	4.70	1.55	4.60	1.58	4.50	1.61	4.40	1.64	4.30	1.67
	0.0	-2.0	6.00	1.70	5.90	1.73	5.70	1.77	5.60	1.81	5.40	1.84
	5.0	3.0	6.70	1.70	6.60	1.73	6.40	1.77	6.20	1.81	6.10	1.84
	7.0	6.0	6.70	1.61	6.60	1.65	6.40	1.68	6.20	1.71	6.10	1.75
	10.0	8.0	6.70	1.51	6.60	1.55	6.40	1.58	6.20	1.61	6.10	1.64
	15.0	10.0	6.70	1.39	6.60	1.42	6.40	1.45	6.20	1.48	6.10	1.50
	20.0	15.0	6.70	1.17	6.60	1.20	6.40	1.22	6.20	1.25	6.10	1.27
24.0	18.0	6.70	1.03	6.60	1.05	6.40	1.07	6.20	1.09	6.10	1.12	

OUTDOOR UNIT

OUTDOOR UNIT

OUTDOOR UNIT

OUTDOOR UNIT

Indoor unit connecting capacity	Outdoor temperature		Indoor temperature									
			16.0 °CDB		18.0 °CDB		20.0 °CDB		22.0 °CDB		24.0 °CDB	
	kBtu/h	°CDB	°CWB	TC	IP	TC	IP	TC	IP	TC	IP	TC
14	-15.0	-16.0	3.20	1.22	3.10	1.24	3.00	1.27	2.90	1.30	2.90	1.32
	-10.0	-11.0	3.60	1.26	3.60	1.28	3.50	1.31	3.40	1.34	3.30	1.36
	-5.0	-7.0	4.10	1.30	4.00	1.32	3.90	1.35	3.80	1.38	3.70	1.40
	0.0	-2.0	5.30	1.43	5.10	1.46	5.00	1.49	4.90	1.52	4.80	1.55
	5.0	3.0	5.90	1.43	5.70	1.46	5.60	1.49	5.50	1.52	5.30	1.55
	7.0	6.0	5.90	1.35	5.70	1.38	5.60	1.41	5.50	1.44	5.30	1.47
	10.0	8.0	5.90	1.27	5.70	1.30	5.60	1.32	5.50	1.35	5.30	1.38
	15.0	10.0	5.90	1.17	5.70	1.19	5.60	1.21	5.50	1.24	5.30	1.26
	20.0	15.0	5.90	0.99	5.70	1.01	5.60	1.03	5.50	1.05	5.30	1.07
	24.0	18.0	5.90	0.86	5.70	0.88	5.60	0.90	5.50	0.92	5.30	0.94
12	-15.0	-16.0	2.77	1.03	2.70	1.05	2.64	1.07	2.57	1.09	2.51	1.11
	-10.0	-11.0	3.19	1.06	3.11	1.08	3.04	1.10	2.96	1.12	2.88	1.14
	-5.0	-7.0	3.61	1.08	3.52	1.11	3.43	1.13	3.35	1.15	3.26	1.18
	0.0	-2.0	4.60	1.20	4.49	1.23	4.38	1.25	4.27	1.28	4.16	1.30
	5.0	3.0	5.15	1.20	5.02	1.23	4.90	1.25	4.78	1.28	4.66	1.30
	7.0	6.0	5.15	1.13	5.02	1.16	4.90	1.18	4.78	1.20	4.66	1.23
	10.0	8.0	5.15	1.06	5.02	1.09	4.90	1.11	4.78	1.13	4.66	1.15
	15.0	10.0	5.15	0.98	5.02	1.00	4.90	1.02	4.78	1.04	4.66	1.06
	20.0	15.0	5.15	0.82	5.02	0.84	4.90	0.86	4.78	0.88	4.66	0.89
	24.0	18.0	5.15	0.72	5.02	0.74	4.90	0.75	4.78	0.77	4.66	0.78
10	-15.0	-16.0	2.37	0.82	2.32	0.83	2.26	0.85	2.20	0.87	2.15	0.88
	-10.0	-11.0	2.73	0.84	2.67	0.86	2.60	0.88	2.54	0.90	2.47	0.92
	-5.0	-7.0	3.09	0.86	3.02	0.88	2.94	0.90	2.87	0.92	2.80	0.94
	0.0	-2.0	3.94	0.95	3.85	0.97	3.75	0.99	3.66	1.01	3.57	1.03
	5.0	3.0	4.41	0.95	4.31	0.97	4.20	0.99	4.10	1.01	3.99	1.03
	7.0	6.0	4.41	0.90	4.31	0.92	4.20	0.94	4.10	0.96	3.99	0.98
	10.0	8.0	4.41	0.85	4.31	0.86	4.20	0.88	4.10	0.90	3.99	0.92
	15.0	10.0	4.41	0.78	4.31	0.79	4.20	0.81	4.10	0.83	3.99	0.84
	20.0	15.0	4.41	0.66	4.31	0.67	4.20	0.68	4.10	0.70	3.99	0.71
	24.0	18.0	4.41	0.58	4.31	0.59	4.20	0.60	4.10	0.61	3.99	0.62

NOTES:

- TC: Total Capacity (kW), IP: Input Power (kW)
- Values mentioned in the table are based on the following conditions:
 - Power source of specifications: 230 V
 - Pipe length: 5 m, Height difference: 0 m (Outdoor unit—Indoor unit)
- 2 or more indoor units should be connected.
- The total ability of connected a indoor unit is from 10,000 Btu/h up to 26,000 Btu/h.
- Input in the table are calculated based on the maximum indoor unit input combinations.

● Compact cassette type

Model: AUXG07KVLA

Outdoor temperature		Indoor temperature (°CDB)				
		16.0	18.0	20.0	22.0	24.0
(°CDB)	(°CWB)	TC	TC	TC	TC	TC
-15.0	-16.0	1.58	1.55	1.51	1.47	1.43
-10.0	-11.0	1.82	1.78	1.74	1.69	1.65
-5.0	-7.0	2.06	2.01	1.96	1.91	1.86
0.0	-2.0	2.63	2.56	2.50	2.44	2.38
5.0	3.0	2.94	2.87	2.80	2.73	2.66
7.0	6.0	2.94	2.87	2.80	2.73	2.66
10.0	8.0	2.94	2.87	2.80	2.73	2.66
15.0	10.0	2.94	2.87	2.80	2.73	2.66
20.0	15.0	2.94	2.87	2.80	2.73	2.66
24.0	18.0	2.94	2.87	2.80	2.73	2.66

Model: AUXG09KVLA

Outdoor temperature		Indoor temperature (°CDB)				
		16.0	18.0	20.0	22.0	24.0
(°CDB)	(°CWB)	TC	TC	TC	TC	TC
-15.0	-16.0	2.04	1.99	1.94	1.89	1.84
-10.0	-11.0	2.34	2.29	2.23	2.18	2.12
-5.0	-7.0	2.65	2.59	2.52	2.46	2.40
0.0	-2.0	3.38	3.30	3.22	3.14	3.06
5.0	3.0	3.78	3.69	3.60	3.51	3.42
7.0	6.0	3.78	3.69	3.60	3.51	3.42
10.0	8.0	3.78	3.69	3.60	3.51	3.42
15.0	10.0	3.78	3.69	3.60	3.51	3.42
20.0	15.0	3.78	3.69	3.60	3.51	3.42
24.0	18.0	3.78	3.69	3.60	3.51	3.42

Model: AUXG12KVLA

Outdoor temperature		Indoor temperature (°CDB)				
		16.0	18.0	20.0	22.0	24.0
(°CDB)	(°CWB)	TC	TC	TC	TC	TC
-15.0	-16.0	2.50	2.44	2.38	2.32	2.26
-10.0	-11.0	2.88	2.81	2.74	2.67	2.60
-5.0	-7.0	3.25	3.18	3.10	3.02	2.94
0.0	-2.0	4.15	4.05	3.95	3.85	3.75
5.0	3.0	4.64	4.53	4.42	4.31	4.20
7.0	6.0	4.64	4.53	4.42	4.31	4.20
10.0	8.0	4.64	4.53	4.42	4.31	4.20
15.0	10.0	4.64	4.53	4.42	4.31	4.20
20.0	15.0	4.64	4.53	4.42	4.31	4.20
24.0	18.0	4.64	4.53	4.42	4.31	4.20

Model: AUXG14KVLA

Outdoor temperature		Indoor temperature (°CDB)				
		16.0	18.0	20.0	22.0	24.0
(°CDB)	(°CWB)	TC	TC	TC	TC	TC
-15.0	-16.0	2.64	2.58	2.51	2.45	2.39
-10.0	-11.0	3.04	2.97	2.89	2.82	2.75
-5.0	-7.0	3.44	3.36	3.27	3.19	3.11
0.0	-2.0	4.38	4.28	4.17	4.07	3.96
5.0	3.0	4.90	4.79	4.67	4.55	4.44
7.0	6.0	4.90	4.79	4.67	4.55	4.44
10.0	8.0	4.90	4.79	4.67	4.55	4.44
15.0	10.0	4.90	4.79	4.67	4.55	4.44
20.0	15.0	4.90	4.79	4.67	4.55	4.44
24.0	18.0	4.90	4.79	4.67	4.55	4.44

NOTES:

- TC: Total Capacity (kW)
- Values mentioned in the table are based on the following conditions:
 - Pipe length: 5 m, Height difference: 0 m (Outdoor unit—Indoor unit)

● Mini duct type

Model: ARXG07KSLAP

Outdoor temperature		Indoor temperature (°CDB)				
		16.0	18.0	20.0	22.0	24.0
(°CDB)	(°CWB)	TC	TC	TC	TC	TC
-15.0	-16.0	1.58	1.55	1.51	1.47	1.43
-10.0	-11.0	1.82	1.78	1.74	1.69	1.65
-5.0	-7.0	2.06	2.01	1.96	1.91	1.86
0.0	-2.0	2.63	2.56	2.50	2.44	2.38
5.0	3.0	2.94	2.87	2.80	2.73	2.66
7.0	6.0	2.94	2.87	2.80	2.73	2.66
10.0	8.0	2.94	2.87	2.80	2.73	2.66
15.0	10.0	2.94	2.87	2.80	2.73	2.66
20.0	15.0	2.94	2.87	2.80	2.73	2.66
24.0	18.0	2.94	2.87	2.80	2.73	2.66

Model: ARXG09KSLAP

Outdoor temperature		Indoor temperature (°CDB)				
		16.0	18.0	20.0	22.0	24.0
(°CDB)	(°CWB)	TC	TC	TC	TC	TC
-15.0	-16.0	2.04	1.99	1.94	1.89	1.84
-10.0	-11.0	2.34	2.29	2.23	2.18	2.12
-5.0	-7.0	2.65	2.59	2.52	2.46	2.40
0.0	-2.0	3.38	3.30	3.22	3.14	3.06
5.0	3.0	3.78	3.69	3.60	3.51	3.42
7.0	6.0	3.78	3.69	3.60	3.51	3.42
10.0	8.0	3.78	3.69	3.60	3.51	3.42
15.0	10.0	3.78	3.69	3.60	3.51	3.42
20.0	15.0	3.78	3.69	3.60	3.51	3.42
24.0	18.0	3.78	3.69	3.60	3.51	3.42

Model: ARXG12KSLAP

Outdoor temperature		Indoor temperature (°CDB)				
		16.0	18.0	20.0	22.0	24.0
(°CDB)	(°CWB)	TC	TC	TC	TC	TC
-15.0	-16.0	2.50	2.44	2.38	2.32	2.26
-10.0	-11.0	2.88	2.81	2.74	2.67	2.60
-5.0	-7.0	3.25	3.18	3.10	3.02	2.94
0.0	-2.0	4.15	4.05	3.95	3.85	3.75
5.0	3.0	4.64	4.53	4.42	4.31	4.20
7.0	6.0	4.64	4.53	4.42	4.31	4.20
10.0	8.0	4.64	4.53	4.42	4.31	4.20
15.0	10.0	4.64	4.53	4.42	4.31	4.20
20.0	15.0	4.64	4.53	4.42	4.31	4.20
24.0	18.0	4.64	4.53	4.42	4.31	4.20

Model: ARXG14KSLAP

Outdoor temperature		Indoor temperature (°CDB)				
		16.0	18.0	20.0	22.0	24.0
(°CDB)	(°CWB)	TC	TC	TC	TC	TC
-15.0	-16.0	2.64	2.58	2.51	2.45	2.39
-10.0	-11.0	3.04	2.97	2.89	2.82	2.75
-5.0	-7.0	3.44	3.36	3.27	3.19	3.11
0.0	-2.0	4.38	4.28	4.17	4.07	3.96
5.0	3.0	4.90	4.79	4.67	4.55	4.44
7.0	6.0	4.90	4.79	4.67	4.55	4.44
10.0	8.0	4.90	4.79	4.67	4.55	4.44
15.0	10.0	4.90	4.79	4.67	4.55	4.44
20.0	15.0	4.90	4.79	4.67	4.55	4.44
24.0	18.0	4.90	4.79	4.67	4.55	4.44

NOTES:

- TC: Total Capacity (kW)
- Values mentioned in the table are based on the following conditions:
 - Pipe length: 5 m, Height difference: 0 m [Outdoor unit—Indoor unit]

● Slim duct type

Model: ARXG07KLLAP

Outdoor temperature		Indoor temperature (°CDB)				
		16.0	18.0	20.0	22.0	24.0
(°CDB)	(°CWB)	TC	TC	TC	TC	TC
-15.0	-16.0	1.58	1.55	1.51	1.47	1.43
-10.0	-11.0	1.82	1.78	1.74	1.69	1.65
-5.0	-7.0	2.06	2.01	1.96	1.91	1.86
0.0	-2.0	2.63	2.56	2.50	2.44	2.38
5.0	3.0	2.94	2.87	2.80	2.73	2.66
7.0	6.0	2.94	2.87	2.80	2.73	2.66
10.0	8.0	2.94	2.87	2.80	2.73	2.66
15.0	10.0	2.94	2.87	2.80	2.73	2.66
20.0	15.0	2.94	2.87	2.80	2.73	2.66
24.0	18.0	2.94	2.87	2.80	2.73	2.66

Model: ARXG09KLLAP

Outdoor temperature		Indoor temperature (°CDB)				
		16.0	18.0	20.0	22.0	24.0
(°CDB)	(°CWB)	TC	TC	TC	TC	TC
-15.0	-16.0	2.04	1.99	1.94	1.89	1.84
-10.0	-11.0	2.34	2.29	2.23	2.18	2.12
-5.0	-7.0	2.65	2.59	2.52	2.46	2.40
0.0	-2.0	3.38	3.30	3.22	3.14	3.06
5.0	3.0	3.78	3.69	3.60	3.51	3.42
7.0	6.0	3.78	3.69	3.60	3.51	3.42
10.0	8.0	3.78	3.69	3.60	3.51	3.42
15.0	10.0	3.78	3.69	3.60	3.51	3.42
20.0	15.0	3.78	3.69	3.60	3.51	3.42
24.0	18.0	3.78	3.69	3.60	3.51	3.42

Model: ARXG12KLLAP

Outdoor temperature		Indoor temperature (°CDB)				
		16.0	18.0	20.0	22.0	24.0
(°CDB)	(°CWB)	TC	TC	TC	TC	TC
-15.0	-16.0	2.50	2.44	2.38	2.32	2.26
-10.0	-11.0	2.88	2.81	2.74	2.67	2.60
-5.0	-7.0	3.25	3.18	3.10	3.02	2.94
0.0	-2.0	4.15	4.05	3.95	3.85	3.75
5.0	3.0	4.64	4.53	4.42	4.31	4.20
7.0	6.0	4.64	4.53	4.42	4.31	4.20
10.0	8.0	4.64	4.53	4.42	4.31	4.20
15.0	10.0	4.64	4.53	4.42	4.31	4.20
20.0	15.0	4.64	4.53	4.42	4.31	4.20
24.0	18.0	4.64	4.53	4.42	4.31	4.20

Model: ARXG14KLLAP

Outdoor temperature		Indoor temperature (°CDB)				
		16.0	18.0	20.0	22.0	24.0
(°CDB)	(°CWB)	TC	TC	TC	TC	TC
-15.0	-16.0	2.64	2.58	2.51	2.45	2.39
-10.0	-11.0	3.04	2.97	2.89	2.82	2.75
-5.0	-7.0	3.44	3.36	3.27	3.19	3.11
0.0	-2.0	4.38	4.28	4.17	4.07	3.96
5.0	3.0	4.90	4.79	4.67	4.55	4.44
7.0	6.0	4.90	4.79	4.67	4.55	4.44
10.0	8.0	4.90	4.79	4.67	4.55	4.44
15.0	10.0	4.90	4.79	4.67	4.55	4.44
20.0	15.0	4.90	4.79	4.67	4.55	4.44
24.0	18.0	4.90	4.79	4.67	4.55	4.44

NOTES:

- TC: Total Capacity (kW)
- Values mentioned in the table are based on the following conditions:
 - Pipe length: 5 m, Height difference: 0 m (Outdoor unit—Indoor unit)

● Medium static pressure duct type

Model: ARXH12KMTAP

Outdoor temperature		Indoor temperature (°CDB)				
		16.0	18.0	20.0	22.0	24.0
(°CDB)	(°CWB)	TC	TC	TC	TC	TC
-15.0	-16.0	2.50	2.44	2.38	2.32	2.26
-10.0	-11.0	2.88	2.81	2.74	2.67	2.60
-5.0	-7.0	3.25	3.18	3.10	3.02	2.94
0.0	-2.0	4.15	4.05	3.95	3.85	3.75
5.0	3.0	4.64	4.53	4.42	4.31	4.20
7.0	6.0	4.64	4.53	4.42	4.31	4.20
10.0	8.0	4.64	4.53	4.42	4.31	4.20
15.0	10.0	4.64	4.53	4.42	4.31	4.20
20.0	15.0	4.64	4.53	4.42	4.31	4.20
24.0	18.0	4.64	4.53	4.42	4.31	4.20

Model: ARXH14KMTAP

Outdoor temperature		Indoor temperature (°CDB)				
		16.0	18.0	20.0	22.0	24.0
(°CDB)	(°CWB)	TC	TC	TC	TC	TC
-15.0	-16.0	2.64	2.58	2.51	2.45	2.39
-10.0	-11.0	3.04	2.97	2.89	2.82	2.75
-5.0	-7.0	3.44	3.36	3.27	3.19	3.11
0.0	-2.0	4.38	4.28	4.17	4.07	3.96
5.0	3.0	4.90	4.79	4.67	4.55	4.44
7.0	6.0	4.90	4.79	4.67	4.55	4.44
10.0	8.0	4.90	4.79	4.67	4.55	4.44
15.0	10.0	4.90	4.79	4.67	4.55	4.44
20.0	15.0	4.90	4.79	4.67	4.55	4.44
24.0	18.0	4.90	4.79	4.67	4.55	4.44

NOTES:

- TC: Total Capacity (kW)
- Values mentioned in the table are based on the following conditions:
 - Pipe length: 5 m, Height difference: 0 m (Outdoor unit—Indoor unit)

● Wall mounted type

Model: ASEH07KMCG, ASEH07KMCG-B

Outdoor temperature		Indoor temperature (°CDB)				
		16.0	18.0	20.0	22.0	24.0
(°CDB)	(°CWB)	TC	TC	TC	TC	TC
-15.0	-16.0	1.58	1.55	1.51	1.47	1.43
-10.0	-11.0	1.82	1.78	1.74	1.69	1.65
-5.0	-7.0	2.06	2.01	1.96	1.91	1.86
0.0	-2.0	2.63	2.56	2.50	2.44	2.38
5.0	3.0	2.94	2.87	2.80	2.73	2.66
7.0	6.0	2.94	2.87	2.80	2.73	2.66
10.0	8.0	2.94	2.87	2.80	2.73	2.66
15.0	10.0	2.94	2.87	2.80	2.73	2.66
20.0	15.0	2.94	2.87	2.80	2.73	2.66
24.0	18.0	2.94	2.87	2.80	2.73	2.66

Model: ASEH09KMCG, ASEH09KMCG-B

Outdoor temperature		Indoor temperature (°CDB)				
		16.0	18.0	20.0	22.0	24.0
(°CDB)	(°CWB)	TC	TC	TC	TC	TC
-15.0	-16.0	2.04	1.99	1.94	1.89	1.84
-10.0	-11.0	2.34	2.29	2.23	2.18	2.12
-5.0	-7.0	2.65	2.59	2.52	2.46	2.40
0.0	-2.0	3.38	3.30	3.22	3.14	3.06
5.0	3.0	3.78	3.69	3.60	3.51	3.42
7.0	6.0	3.78	3.69	3.60	3.51	3.42
10.0	8.0	3.78	3.69	3.60	3.51	3.42
15.0	10.0	3.78	3.69	3.60	3.51	3.42
20.0	15.0	3.78	3.69	3.60	3.51	3.42
24.0	18.0	3.78	3.69	3.60	3.51	3.42

Model: ASEH12KMCG, ASEH12KMCG-B

Outdoor temperature		Indoor temperature (°CDB)				
		16.0	18.0	20.0	22.0	24.0
(°CDB)	(°CWB)	TC	TC	TC	TC	TC
-15.0	-16.0	2.50	2.44	2.38	2.32	2.26
-10.0	-11.0	2.88	2.81	2.74	2.67	2.60
-5.0	-7.0	3.25	3.18	3.10	3.02	2.94
0.0	-2.0	4.15	4.05	3.95	3.85	3.75
5.0	3.0	4.64	4.53	4.42	4.31	4.20
7.0	6.0	4.64	4.53	4.42	4.31	4.20
10.0	8.0	4.64	4.53	4.42	4.31	4.20
15.0	10.0	4.64	4.53	4.42	4.31	4.20
20.0	15.0	4.64	4.53	4.42	4.31	4.20
24.0	18.0	4.64	4.53	4.42	4.31	4.20

Model: ASEH14KMCG, ASEH14KMCG-B

Outdoor temperature		Indoor temperature (°CDB)				
		16.0	18.0	20.0	22.0	24.0
(°CDB)	(°CWB)	TC	TC	TC	TC	TC
-15.0	-16.0	2.64	2.58	2.51	2.45	2.39
-10.0	-11.0	3.04	2.97	2.89	2.82	2.75
-5.0	-7.0	3.44	3.36	3.27	3.19	3.11
0.0	-2.0	4.38	4.28	4.17	4.07	3.96
5.0	3.0	4.90	4.79	4.67	4.55	4.44
7.0	6.0	4.90	4.79	4.67	4.55	4.44
10.0	8.0	4.90	4.79	4.67	4.55	4.44
15.0	10.0	4.90	4.79	4.67	4.55	4.44
20.0	15.0	4.90	4.79	4.67	4.55	4.44
24.0	18.0	4.90	4.79	4.67	4.55	4.44

Models: ASEG07KETF and ASEG07KETF-B

Outdoor temperature		Indoor temperature (°CDB)				
		16.0	18.0	20.0	22.0	24.0
(°CDB)	(°CWB)	TC	TC	TC	TC	TC
-15.0	-16.0	1.58	1.55	1.51	1.47	1.43
-10.0	-11.0	1.82	1.78	1.74	1.69	1.65
-5.0	-7.0	2.06	2.01	1.96	1.91	1.86
0.0	-2.0	2.63	2.56	2.50	2.44	2.38
5.0	3.0	2.94	2.87	2.80	2.73	2.66
7.0	6.0	2.94	2.87	2.80	2.73	2.66
10.0	8.0	2.94	2.87	2.80	2.73	2.66
15.0	10.0	2.94	2.87	2.80	2.73	2.66
20.0	15.0	2.94	2.87	2.80	2.73	2.66
24.0	18.0	2.94	2.87	2.80	2.73	2.66

Models: ASEG09KETF and ASEG09KETF-B

Outdoor temperature		Indoor temperature (°CDB)				
		16.0	18.0	20.0	22.0	24.0
(°CDB)	(°CWB)	TC	TC	TC	TC	TC
-15.0	-16.0	2.04	1.99	1.94	1.89	1.84
-10.0	-11.0	2.34	2.29	2.23	2.18	2.12
-5.0	-7.0	2.65	2.59	2.52	2.46	2.40
0.0	-2.0	3.38	3.30	3.22	3.14	3.06
5.0	3.0	3.78	3.69	3.60	3.51	3.42
7.0	6.0	3.78	3.69	3.60	3.51	3.42
10.0	8.0	3.78	3.69	3.60	3.51	3.42
15.0	10.0	3.78	3.69	3.60	3.51	3.42
20.0	15.0	3.78	3.69	3.60	3.51	3.42
24.0	18.0	3.78	3.69	3.60	3.51	3.42

Models: ASEG12KETF and ASEG12KETF-B

Outdoor temperature		Indoor temperature (°CDB)				
		16.0	18.0	20.0	22.0	24.0
(°CDB)	(°CWB)	TC	TC	TC	TC	TC
-15.0	-16.0	2.50	2.44	2.38	2.32	2.26
-10.0	-11.0	2.88	2.81	2.74	2.67	2.60
-5.0	-7.0	3.25	3.18	3.10	3.02	2.94
0.0	-2.0	4.15	4.05	3.95	3.85	3.75
5.0	3.0	4.64	4.53	4.42	4.31	4.20
7.0	6.0	4.64	4.53	4.42	4.31	4.20
10.0	8.0	4.64	4.53	4.42	4.31	4.20
15.0	10.0	4.64	4.53	4.42	4.31	4.20
20.0	15.0	4.64	4.53	4.42	4.31	4.20
24.0	18.0	4.64	4.53	4.42	4.31	4.20

Models: ASEG14KETF and ASEG14KETF-B

Outdoor temperature		Indoor temperature (°CDB)				
		16.0	18.0	20.0	22.0	24.0
(°CDB)	(°CWB)	TC	TC	TC	TC	TC
-15.0	-16.0	2.64	2.58	2.51	2.45	2.39
-10.0	-11.0	3.04	2.97	2.89	2.82	2.75
-5.0	-7.0	3.44	3.36	3.27	3.19	3.11
0.0	-2.0	4.38	4.28	4.17	4.07	3.96
5.0	3.0	4.90	4.79	4.67	4.55	4.44
7.0	6.0	4.90	4.79	4.67	4.55	4.44
10.0	8.0	4.90	4.79	4.67	4.55	4.44
15.0	10.0	4.90	4.79	4.67	4.55	4.44
20.0	15.0	4.90	4.79	4.67	4.55	4.44
24.0	18.0	4.90	4.79	4.67	4.55	4.44

Model: ASEH07KGTG

Outdoor temperature		Indoor temperature (°CDB)				
		16.0	18.0	20.0	22.0	24.0
(°CDB)	(°CWB)	TC	TC	TC	TC	TC
-15.0	-16.0	1.58	1.55	1.51	1.47	1.43
-10.0	-11.0	1.82	1.78	1.74	1.69	1.65
-5.0	-7.0	2.06	2.01	1.96	1.91	1.86
0.0	-2.0	2.63	2.56	2.50	2.44	2.38
5.0	3.0	2.94	2.87	2.80	2.73	2.66
7.0	6.0	2.94	2.87	2.80	2.73	2.66
10.0	8.0	2.94	2.87	2.80	2.73	2.66
15.0	10.0	2.94	2.87	2.80	2.73	2.66
20.0	15.0	2.94	2.87	2.80	2.73	2.66
24.0	18.0	2.94	2.87	2.80	2.73	2.66

Model: ASEH09KGTG

Outdoor temperature		Indoor temperature (°CDB)				
		16.0	18.0	20.0	22.0	24.0
(°CDB)	(°CWB)	TC	TC	TC	TC	TC
-15.0	-16.0	2.04	1.99	1.94	1.89	1.84
-10.0	-11.0	2.34	2.29	2.23	2.18	2.12
-5.0	-7.0	2.65	2.59	2.52	2.46	2.40
0.0	-2.0	3.38	3.30	3.22	3.14	3.06
5.0	3.0	3.78	3.69	3.60	3.51	3.42
7.0	6.0	3.78	3.69	3.60	3.51	3.42
10.0	8.0	3.78	3.69	3.60	3.51	3.42
15.0	10.0	3.78	3.69	3.60	3.51	3.42
20.0	15.0	3.78	3.69	3.60	3.51	3.42
24.0	18.0	3.78	3.69	3.60	3.51	3.42

Model: ASEH12KGTG

Outdoor temperature		Indoor temperature (°CDB)				
		16.0	18.0	20.0	22.0	24.0
(°CDB)	(°CWB)	TC	TC	TC	TC	TC
-15.0	-16.0	2.50	2.44	2.38	2.32	2.26
-10.0	-11.0	2.88	2.81	2.74	2.67	2.60
-5.0	-7.0	3.25	3.18	3.10	3.02	2.94
0.0	-2.0	4.15	4.05	3.95	3.85	3.75
5.0	3.0	4.64	4.53	4.42	4.31	4.20
7.0	6.0	4.64	4.53	4.42	4.31	4.20
10.0	8.0	4.64	4.53	4.42	4.31	4.20
15.0	10.0	4.64	4.53	4.42	4.31	4.20
20.0	15.0	4.64	4.53	4.42	4.31	4.20
24.0	18.0	4.64	4.53	4.42	4.31	4.20

Model: ASEH14KGTG

Outdoor temperature		Indoor temperature (°CDB)				
		16.0	18.0	20.0	22.0	24.0
(°CDB)	(°CWB)	TC	TC	TC	TC	TC
-15.0	-16.0	2.64	2.58	2.51	2.45	2.39
-10.0	-11.0	3.04	2.97	2.89	2.82	2.75
-5.0	-7.0	3.44	3.36	3.27	3.19	3.11
0.0	-2.0	4.38	4.28	4.17	4.07	3.96
5.0	3.0	4.90	4.79	4.67	4.55	4.44
7.0	6.0	4.90	4.79	4.67	4.55	4.44
10.0	8.0	4.90	4.79	4.67	4.55	4.44
15.0	10.0	4.90	4.79	4.67	4.55	4.44
20.0	15.0	4.90	4.79	4.67	4.55	4.44
24.0	18.0	4.90	4.79	4.67	4.55	4.44

Model: ASEH05KNCA

Outdoor temperature		Indoor temperature (°CDB)				
		16.0	18.0	20.0	22.0	24.0
(°CDB)	(°CWB)	TC	TC	TC	TC	TC
-15.0	-16.0	1.19	1.16	1.13	1.10	1.07
-10.0	-11.0	1.37	1.33	1.30	1.27	1.24
-5.0	-7.0	1.55	1.51	1.47	1.44	1.40
0.0	-2.0	1.97	1.92	1.88	1.83	1.78
5.0	3.0	2.21	2.15	2.10	2.05	2.00
7.0	6.0	2.21	2.15	2.10	2.05	2.00
10.0	8.0	2.21	2.15	2.10	2.05	2.00
15.0	10.0	2.21	2.15	2.10	2.05	2.00
20.0	15.0	2.21	2.15	2.10	2.05	2.00
24.0	18.0	2.21	2.15	2.10	2.05	2.00

Model: ASEH07KNCA

Outdoor temperature		Indoor temperature (°CDB)				
		16.0	18.0	20.0	22.0	24.0
(°CDB)	(°CWB)	TC	TC	TC	TC	TC
-15.0	-16.0	1.58	1.55	1.51	1.47	1.43
-10.0	-11.0	1.82	1.78	1.74	1.69	1.65
-5.0	-7.0	2.06	2.01	1.96	1.91	1.86
0.0	-2.0	2.63	2.56	2.50	2.44	2.38
5.0	3.0	2.94	2.87	2.80	2.73	2.66
7.0	6.0	2.94	2.87	2.80	2.73	2.66
10.0	8.0	2.94	2.87	2.80	2.73	2.66
15.0	10.0	2.94	2.87	2.80	2.73	2.66
20.0	15.0	2.94	2.87	2.80	2.73	2.66
24.0	18.0	2.94	2.87	2.80	2.73	2.66

Model: ASEH09KNCA

Outdoor temperature		Indoor temperature (°CDB)				
		16.0	18.0	20.0	22.0	24.0
(°CDB)	(°CWB)	TC	TC	TC	TC	TC
-15.0	-16.0	2.04	1.99	1.94	1.89	1.84
-10.0	-11.0	2.34	2.29	2.23	2.18	2.12
-5.0	-7.0	2.65	2.59	2.52	2.46	2.40
0.0	-2.0	3.38	3.30	3.22	3.14	3.06
5.0	3.0	3.78	3.69	3.60	3.51	3.42
7.0	6.0	3.78	3.69	3.60	3.51	3.42
10.0	8.0	3.78	3.69	3.60	3.51	3.42
15.0	10.0	3.78	3.69	3.60	3.51	3.42
20.0	15.0	3.78	3.69	3.60	3.51	3.42
24.0	18.0	3.78	3.69	3.60	3.51	3.42

Model: ASEH12KNCA

Outdoor temperature		Indoor temperature (°CDB)				
		16.0	18.0	20.0	22.0	24.0
(°CDB)	(°CWB)	TC	TC	TC	TC	TC
-15.0	-16.0	2.50	2.44	2.38	2.32	2.26
-10.0	-11.0	2.88	2.81	2.74	2.67	2.60
-5.0	-7.0	3.25	3.18	3.10	3.02	2.94
0.0	-2.0	4.15	4.05	3.95	3.85	3.75
5.0	3.0	4.64	4.53	4.42	4.31	4.20
7.0	6.0	4.64	4.53	4.42	4.31	4.20
10.0	8.0	4.64	4.53	4.42	4.31	4.20
15.0	10.0	4.64	4.53	4.42	4.31	4.20
20.0	15.0	4.64	4.53	4.42	4.31	4.20
24.0	18.0	4.64	4.53	4.42	4.31	4.20

NOTES:

- TC: Total Capacity (kW)
- Values mentioned in the table are based on the following conditions:
 - Pipe length: 5 m, Height difference: 0 m (Outdoor unit—Indoor unit)

● Floor type

Model: AGEG09KVCA

Outdoor temperature		Indoor temperature (°CDB)				
		16.0	18.0	20.0	22.0	24.0
(°CDB)	(°CWB)	TC	TC	TC	TC	TC
-15.0	-16.0	2.04	1.99	1.94	1.89	1.84
-10.0	-11.0	2.34	2.29	2.23	2.18	2.12
-5.0	-7.0	2.65	2.59	2.52	2.46	2.40
0.0	-2.0	3.38	3.30	3.22	3.14	3.06
5.0	3.0	3.78	3.69	3.60	3.51	3.42
7.0	6.0	3.78	3.69	3.60	3.51	3.42
10.0	8.0	3.78	3.69	3.60	3.51	3.42
15.0	10.0	3.78	3.69	3.60	3.51	3.42
20.0	15.0	3.78	3.69	3.60	3.51	3.42
24.0	18.0	3.78	3.69	3.60	3.51	3.42

Model: AGEG12KVCA

Outdoor temperature		Indoor temperature (°CDB)				
		16.0	18.0	20.0	22.0	24.0
(°CDB)	(°CWB)	TC	TC	TC	TC	TC
-15.0	-16.0	2.50	2.44	2.38	2.32	2.26
-10.0	-11.0	2.88	2.81	2.74	2.67	2.60
-5.0	-7.0	3.25	3.18	3.10	3.02	2.94
0.0	-2.0	4.15	4.05	3.95	3.85	3.75
5.0	3.0	4.64	4.53	4.42	4.31	4.20
7.0	6.0	4.64	4.53	4.42	4.31	4.20
10.0	8.0	4.64	4.53	4.42	4.31	4.20
15.0	10.0	4.64	4.53	4.42	4.31	4.20
20.0	15.0	4.64	4.53	4.42	4.31	4.20
24.0	18.0	4.64	4.53	4.42	4.31	4.20

Model: AGEG14KVCA

Outdoor temperature		Indoor temperature (°CDB)				
		16.0	18.0	20.0	22.0	24.0
(°CDB)	(°CWB)	TC	TC	TC	TC	TC
-15.0	-16.0	2.64	2.58	2.51	2.45	2.39
-10.0	-11.0	3.04	2.97	2.89	2.82	2.75
-5.0	-7.0	3.44	3.36	3.27	3.19	3.11
0.0	-2.0	4.38	4.28	4.17	4.07	3.96
5.0	3.0	4.90	4.79	4.67	4.55	4.44
7.0	6.0	4.90	4.79	4.67	4.55	4.44
10.0	8.0	4.90	4.79	4.67	4.55	4.44
15.0	10.0	4.90	4.79	4.67	4.55	4.44
20.0	15.0	4.90	4.79	4.67	4.55	4.44
24.0	18.0	4.90	4.79	4.67	4.55	4.44

NOTES:

- TC: Total Capacity (kW)
- Values mentioned in the table are based on the following conditions:
 - Pipe length: 5 m, Height difference: 0 m (Outdoor unit—Indoor unit)

7. Capacity compensation rate for pipe length and height difference

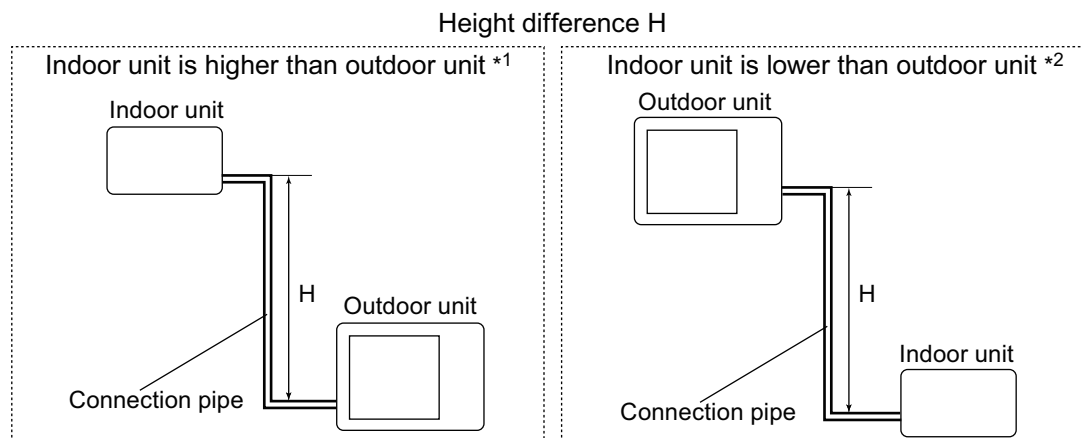

7-1. Model: AOEG14KBCA2

NOTE: Values mentioned in the table are calculated based on the maximum capacity.

■ Indoor unit: 5,000 Btu/h and 7,000 Btu/h

Cooling		Pipe length					
		m	2.5	5	10	15	20
Height difference H (m)	Indoor unit is higher than outdoor unit *1	15	—	—	—	0.936	0.908
		10	—	—	0.969	0.943	0.915
		5	—	0.991	0.976	0.950	0.921
	Indoor unit is lower than outdoor unit *2	2.5	0.993	0.993	0.978	0.952	0.923
		0	1.000	1.000	0.985	0.959	0.930

Heating		Pipe length					
		m	2.5	5	10	15	20
Height difference H (m)	Indoor unit is higher than outdoor unit *1	15	—	—	—	0.937	0.915
		10	—	—	0.956	0.937	0.915
		5	—	1.000	0.956	0.937	0.915
	Indoor unit is lower than outdoor unit *2	2.5	0.990	1.000	0.956	0.937	0.915
		0	0.990	1.000	0.956	0.937	0.915

Indoor unit: 9,000 Btu/h

Cooling		Pipe length					
		m	2.5	5	10	15	20
Height difference H (m)	Indoor unit is higher than outdoor unit *1	15	—	—	—	0.924	0.891
		10	—	—	0.962	0.931	0.899
		5	—	0.991	0.968	0.938	0.905
		2.5	0.993	0.993	0.970	0.940	0.907
		0	1.000	1.000	0.977	0.946	0.913
	Indoor unit is lower than outdoor unit *2	-2.5	1.000	1.000	0.977	0.946	0.913
		-5	—	1.000	0.977	0.946	0.913
		-10	—	—	0.977	0.946	0.913
-15		—	—	—	0.946	0.913	

Heating		Pipe length					
		m	2.5	5	10	15	20
Height difference H (m)	Indoor unit is higher than outdoor unit *1	15	—	—	—	0.937	0.914
		10	—	—	0.956	0.937	0.914
		5	—	1.000	0.956	0.937	0.914
		2.5	0.990	1.000	0.956	0.937	0.914
		0	0.990	1.000	0.956	0.937	0.914
	Indoor unit is lower than outdoor unit *2	-2.5	0.986	0.996	0.952	0.933	0.910
		-5	—	0.994	0.950	0.931	0.908
		-10	—	—	0.946	0.927	0.905
-15		—	—	—	0.923	0.900	

Indoor unit: 12,000 Btu/h

Cooling		Pipe length					
		m	2.5	5	10	15	20
Height difference H (m)	Indoor unit is higher than outdoor unit *1	15	—	—	—	0.914	0.877
		10	—	—	0.959	0.921	0.884
		5	—	0.991	0.965	0.928	0.890
		2.5	0.993	0.993	0.967	0.930	0.893
		0	1.000	1.000	0.974	0.936	0.899
	Indoor unit is lower than outdoor unit *2	-2.5	1.000	1.000	0.974	0.936	0.899
		-5	—	1.000	0.974	0.936	0.899
		-10	—	—	0.974	0.936	0.899
-15		—	—	—	0.936	0.899	

Heating		Pipe length					
		m	2.5	5	10	15	20
Height difference H (m)	Indoor unit is higher than outdoor unit *1	15	—	—	—	0.936	0.914
		10	—	—	0.955	0.936	0.914
		5	—	1.000	0.955	0.936	0.914
		2.5	0.992	1.000	0.955	0.936	0.914
		0	0.992	1.000	0.955	0.936	0.914
	Indoor unit is lower than outdoor unit *2	-2.5	0.988	0.996	0.951	0.932	0.910
		-5	—	0.994	0.949	0.930	0.908
		-10	—	—	0.945	0.927	0.905
-15		—	—	—	0.922	0.900	

7-2. Model: AOEG18KBCA2

NOTE: Values mentioned in the table are calculated based on the maximum capacity.

■ Indoor unit: 5,000 Btu/h and 7,000 Btu/h

Cooling		Pipe length					
		m	2.5	5	10	15	20
Height difference H (m)	Indoor unit is higher than outdoor unit *1	15	—	—	—	0.940	0.914
		10	—	—	0.973	0.948	0.921
		5	—	0.991	0.980	0.955	0.928
		2.5	0.993	0.993	0.982	0.957	0.930
		0	1.000	1.000	0.989	0.963	0.936
Indoor unit is lower than outdoor unit *2	-2.5	1.000	1.000	0.989	0.963	0.936	
	-5	—	1.000	0.989	0.963	0.936	
	-10	—	—	0.989	0.963	0.936	
	-15	—	—	—	0.963	0.936	

Heating		Pipe length					
		m	2.5	5	10	15	20
Height difference H (m)	Indoor unit is higher than outdoor unit *1	15	—	—	—	0.942	0.925
		10	—	—	0.959	0.942	0.925
		5	—	1.000	0.959	0.942	0.925
		2.5	0.990	1.000	0.959	0.942	0.925
		0	0.990	1.000	0.959	0.942	0.925
Indoor unit is lower than outdoor unit *2	-2.5	0.986	0.996	0.955	0.938	0.921	
	-5	—	0.994	0.953	0.936	0.919	
	-10	—	—	0.949	0.933	0.916	
	-15	—	—	—	0.928	0.911	

■ Indoor unit: 9,000 Btu/h

Cooling		Pipe length					
		m	2.5	5	10	15	20
Height difference H (m)	Indoor unit is higher than outdoor unit *1	15	—	—	—	0.928	0.898
		10	—	—	0.966	0.936	0.905
		5	—	0.991	0.972	0.942	0.911
		2.5	0.993	0.993	0.974	0.944	0.913
		0	1.000	1.000	0.981	0.951	0.920
Indoor unit is lower than outdoor unit *2	-2.5	1.000	1.000	0.981	0.951	0.920	
	-5	—	1.000	0.981	0.951	0.920	
	-10	—	—	0.981	0.951	0.920	
	-15	—	—	—	0.951	0.920	

Heating		Pipe length					
		m	2.5	5	10	15	20
Height difference H (m)	Indoor unit is higher than outdoor unit *1	15	—	—	—	0.942	0.924
		10	—	—	0.959	0.942	0.924
		5	—	1.000	0.959	0.942	0.924
		2.5	0.990	1.000	0.959	0.942	0.924
		0	0.990	1.000	0.959	0.942	0.924
Indoor unit is lower than outdoor unit *2	-2.5	0.986	0.996	0.955	0.938	0.920	
	-5	—	0.994	0.953	0.936	0.918	
	-10	—	—	0.949	0.932	0.915	
	-15	—	—	—	0.928	0.910	

■ Indoor unit: 12,000 Btu/h

Cooling		Pipe length					
		m	2.5	5	10	15	20
Height difference H (m)	Indoor unit is higher than outdoor unit *1	15	—	—	—	0.919	0.883
		10	—	—	0.962	0.926	0.891
		5	—	0.991	0.969	0.933	0.897
		2.5	0.993	0.993	0.971	0.935	0.899
	Indoor unit is lower than outdoor unit *2	0	1.000	1.000	0.978	0.941	0.905
		-2.5	1.000	1.000	0.978	0.941	0.905
		-5	—	1.000	0.978	0.941	0.905
		-10	—	—	0.978	0.941	0.905
		-15	—	—	—	0.941	0.905

Heating		Pipe length					
		m	2.5	5	10	15	20
Height difference H (m)	Indoor unit is higher than outdoor unit *1	15	—	—	—	0.941	0.924
		10	—	—	0.958	0.941	0.924
		5	—	1.000	0.958	0.941	0.924
		2.5	0.992	1.000	0.958	0.941	0.924
	Indoor unit is lower than outdoor unit *2	0	0.992	1.000	0.958	0.941	0.924
		-2.5	0.988	0.996	0.954	0.937	0.920
		-5	—	0.994	0.952	0.935	0.918
		-10	—	—	0.948	0.932	0.915
		-15	—	—	—	0.927	0.910

■ Indoor unit: 14,000 Btu/h

Cooling		Pipe length					
		m	2.5	5	10	15	20
Height difference H (m)	Indoor unit is higher than outdoor unit *1	15	—	—	—	0.913	0.873
		10	—	—	0.959	0.919	0.882
		5	—	0.991	0.967	0.927	0.888
		2.5	0.993	0.993	0.969	0.929	0.890
	Indoor unit is lower than outdoor unit *2	0	1.000	1.000	0.976	0.934	0.895
		-2.5	1.000	1.000	0.976	0.934	0.895
		-5	—	1.000	0.976	0.934	0.895
		-10	—	—	0.976	0.934	0.895
		-15	—	—	—	0.934	0.895

Heating		Pipe length					
		m	3	7.5	10	15	20
Height difference H (m)	Indoor unit is higher than outdoor unit *1	15	—	—	—	0.940	0.924
		10	—	—	0.957	0.940	0.924
		5	—	1.000	0.957	0.940	0.924
		2.5	0.993	1.000	0.957	0.940	0.924
	Indoor unit is lower than outdoor unit *2	0	0.993	1.000	0.957	0.940	0.924
		-2.5	0.989	0.996	0.953	0.936	0.920
		-5	—	0.994	0.951	0.934	0.918
		-10	—	—	0.947	0.932	0.915
		-15	—	—	—	0.926	0.910

8. Additional charge calculation

8-1. Model: AOEG14KBCA2

Refrigerant type		R32
Refrigerant amount	g	900

■ Refrigerant charge

Total pipe length	m	20 or less	30 (Max.)	20 g/m
Additional charge	g	0	200	

8-2. Model: AOEG18KBCA2

Refrigerant type		R32
Refrigerant amount	g	1,020

■ Refrigerant charge

Total pipe length	m	20 or less	30 (Max.)	20 g/m
Additional charge	g	0	200	

9. Airflow

9-1. Model: AOEG14KBCA2

● Cooling

m ³ /h	1,670
l/s	464
CFM	983

● Heating

m ³ /h	1,670
l/s	464
CFM	983

9-2. Model: AOEG18KBCA2

● Cooling

m ³ /h	1,960
l/s	544
CFM	1,154

● Heating

m ³ /h	2,020
l/s	561
CFM	1,189

10. Operation noise (sound pressure)

10-1. Noise level curve

Model: AOEG14KBCA2

Cooling

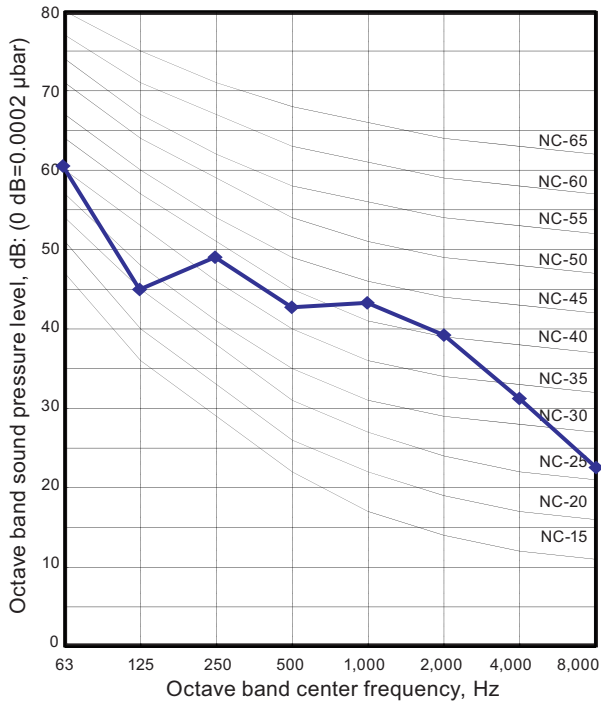

Heating

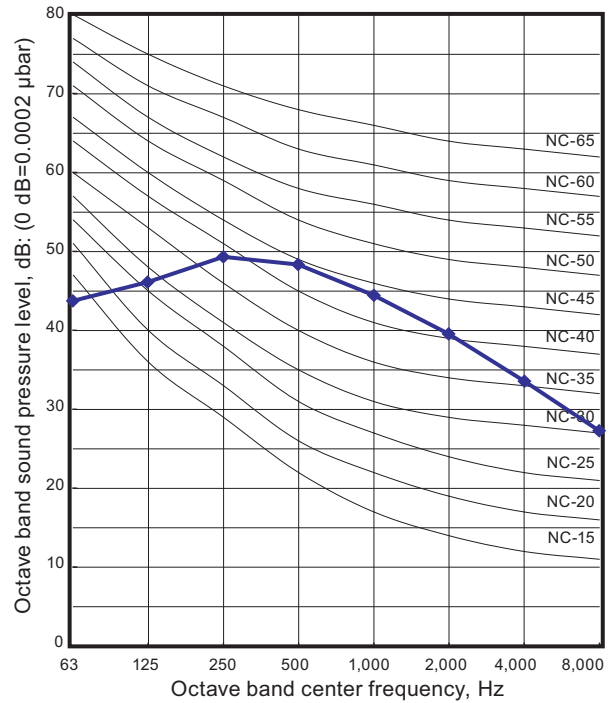

Model: AOEG18KBCA2

Cooling

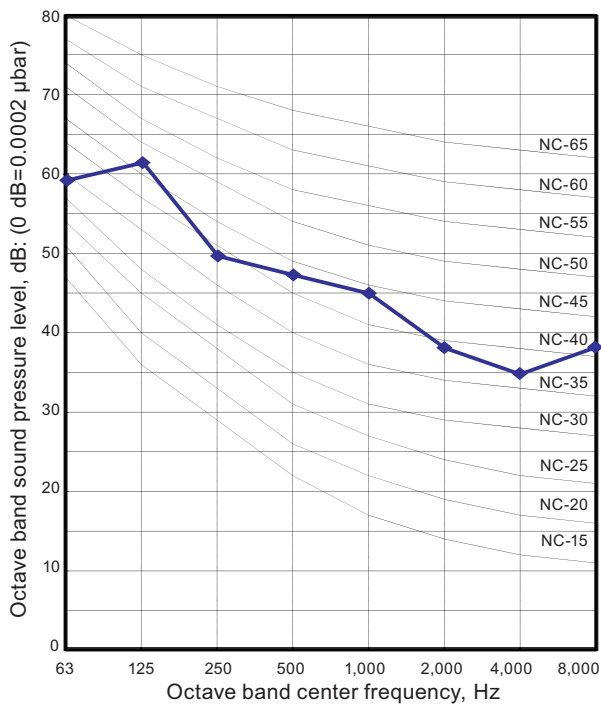

Heating

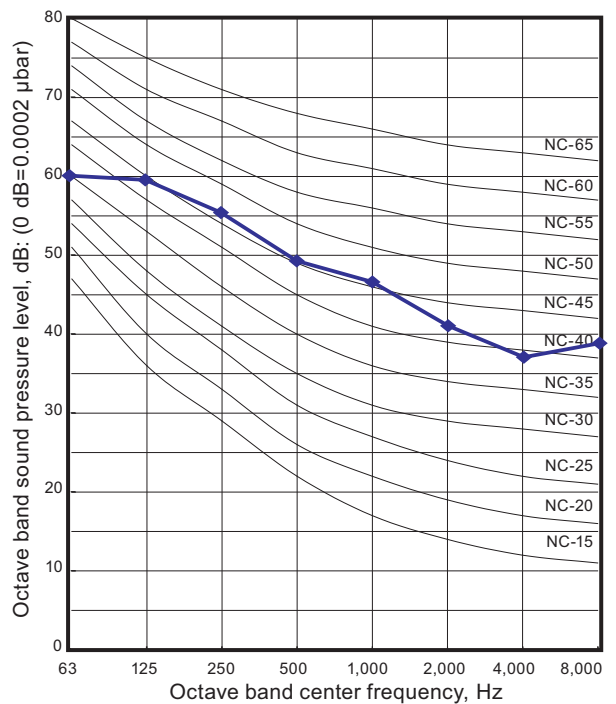

10-2. Sound level check point

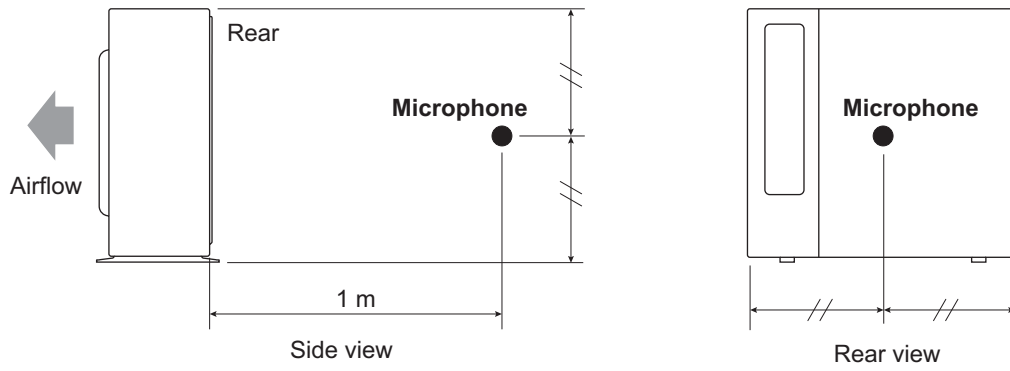

NOTE: Detailed shape of the actual outdoor unit might be slightly different from the one illustrated above.

11. Electrical characteristics

Model name			AOEG14KBCA2	AOEG18KBCA2
Power supply	Voltage	V	230 ~	
	Frequency	Hz	50	
Maximum operating current *1		A	10.9	11.6
Starting current		A	4.7	5.6
Wiring spec. *2	Main fuse (Circuit breaker) current		A	15
	Power cable		mm ²	1.5
	Connection cable *3	Cross-sectional area		1.5
		Limited wiring length		m

*1: Maximum operating current is the total current of the indoor unit and the outdoor unit.

*2: Selected sample based on Japan Electrotechnical Standards and Codes Committee E0005. As the regulations of wire size and circuit breaker differ in each country or region, select appropriate devices complied to the regional standard.



*3: This is the wiring length in case voltage descent is less than 2%. When the wiring length becomes longer, select the wiring of a more larger diameter.

12. Safety devices

Type of protection	Protection form		Model	
			AOEG14KBCA2	AOEG18KBCA2
Circuit protection	Current fuse (Main PCB)		250 V, 5 A 250 V, 20 A 250 V, 3.15 A	250 V, 5 A 250 V, 25 A 250 V, 3.15 A
Fan motor protection	Thermal protector	Activate	127 ±5 °C Fan motor stop	125 ±10 °C Fan motor stop
		Reset	95 °C or less Fan motor restart	120 ±10 °C Fan motor restart
Compressor protection	Temperature thermistor (Discharge temp.)	Activate	110 °C Compressor stop	
		Reset	After 7 minutes Compressor restart	
	Temperature thermistor (Compressor bottom temp.)	Activate	—	108 °C Compressor stop
		Reset	—	After 3 minutes, and 80 °C or less Compressor restart
	Thermal protection program (Outdoor temp.) (Only in COOL or DRY mode)	Activate	-20 °C Compressor stop	
		Reset	-15 °C Compressor restart	

13. Accessories

13-1. Models: AOEG14KBCA2 and AOEG18KBCA2

Part name	Exterior	Qty	Part name	Exterior	Qty
Installation manual		1	Drain pipe		1

14. Outdoor unit installation precautions

NOTE: The information listed below are general precautions.
Some models also include items that do not apply.

14-1. Places where prohibited for use

- Places where there is a danger of combustible gas leakage.
- Places where sulfur gas, chlorine gas, acid, alkali, or other matter which effects equipment is generated.
- Places affected by heat radiation from other heat sources.
- Places where the air is stagnant.
- Places where machinery which generates high frequencies is used.
- Ocean beaches and other areas where there is a lot of salt.
- Inside of vehicles, ships, and other conveyances.
- Places where voltage fluctuations are large such as a factory.

14-2. Points to remember when installing

- The product shall be installed at a place which can withstand the weight and vibration of the outdoor unit.
- To allow maintenance after refrigerant piping, drain piping, and the connection/installation of electric wiring, provide an maintenance space.
Maintenance space is shown in "Installation space" on page 1.
- Be careful when installing the set at the following places.

Condition	Contents	Countermeasures (Reference)
When installed near adjacent houses.	Perform installation work so that operating sound does not disturb the neighbors.	<ol style="list-style-type: none"> 1. Install a soundproof barrier. 2. Change the installation site.
When there is the possibility of strong wind.	<ul style="list-style-type: none"> • If the outdoor unit is exposed to strong wind, capacity may drop, frost may form during heating, and operation may be stopped by high pressure rise. In addition, when a very strong wind blows, the fan may be damaged. • When a very strong wind blows, there is the possibility of the outdoor unit being toppled over if held only by foundation bolts. 	<ol style="list-style-type: none"> 1. Install the outdoor unit with keeping a sufficient distance between the outlet side of the unit and a facing wall or fence. 2. Make the outlet direction and wind direction perpendicular. 3. Fasten the outdoor unit using toppling prevention hardware (purchased locally).
When snow accumulates.	If the outdoor unit is covered by accumulated snow, it may not be able to operate.	<ol style="list-style-type: none"> 1. Make the foundation as high as possible. 2. Perform snow prevention work.
When installing the inverter type.	It may generate noise in TV sets, stereos and PCs.	The inverter type should be installed at a sufficient distance from these equipments.