

OPERATION MANUAL



MODEL:(KG Series)

- * Write down the model name.
(Refer to the rating label.)
- * Bitte schreiben Sie den Modellnamen auf.
(Siehe Typenschild)
- * Veuillez écrire le nom du modèle.
(Consultez l'étiquette des spécifications.)
- * Anote el nombre de modelo.
(Consulte la etiqueta de calificación).
- * Annotare il nome del modello.
(Fare riferimento all'etichetta delle specifiche).
- * Καταγράψτε το όνομα μοντέλου.
(Ανατρέξτε στην ετικέτα τεχνικών στοιχείων.)
- * Registe o nome de modelo.
(Consulte a etiqueta de classificação.)
- * Lütfen model adını not ediniz.
(Derece etiketine bakınız.)

OPERATION MANUAL AIR CONDITIONER (Wall-mounted type)

Before using this product, read these instructions thoroughly and keep this manual for future reference.

BEDIENUNGSANLEITUNG KLIMAANLAGE (Wandmontierter Typ)

Bevor Sie dieses Produkt verwenden, lesen Sie diese Anweisungen sorgfältig durch und bewahren Sie diese Anleitung für späteres Nachschlagen auf.

MODE D'EMPLOI CLIMATISEUR (Type à montage mural)

Avant d'utiliser ce produit, veuillez lire attentivement ces instructions. Conservez ce manuel pour référence future.

MANUAL DE FUNCIONAMIENTO ACONDICIONADOR DE AIRE (Tipo montado en pared)

Antes de utilizar el producto, lea estas instrucciones detenidamente y conserve este manual para consultarlo en el futuro.

MANUALE DI ISTRUZIONI CONDIZIONATORE D'ARIA (Tipo montato a parete)

Prima di utilizzare l'apparecchio, leggere attentamente le presenti istruzioni e conservare il manuale per poterlo consultare il futuro.

ΕΓΧΕΙΡΙΔΙΟ ΛΕΙΤΟΥΡΓΙΑΣ ΚΛΙΜΑΤΙΣΤΙΚΟ (Επιτοίχιος τύπος)

Προτού χρησιμοποιήσετε το προϊόν, διαβάστε προσεκτικά τις παρούσες οδηγίες και φυλάξτε το παρόν εγχειρίδιο, ώστε να μπορείτε να ανατρέχετε σε αυτό στο μέλλον.

MANUAL DE FUNCIONAMENTO AR CONDICIONADO (Tipo mural)

Antes de utilizar este produto, leia atentamente estas instruções e guarde este manual para referência futura.

KULLANIM KILAVUZU KLİMA (Duvara Monte tip)

Bu ürünü kullanmadan önce verilen talimatları dikkatlice okuyun ve daha sonra tekrar faydalanmak üzere saklayın.

English

Deutsch

Français

Español

Italiano

Ελληνικά

Português

Türkçe



PART No. 9387602494-01

Contents

1. SAFETY PRECAUTIONS.....	1
2. PREPARATION.....	2
3. NAME OF PARTS	3
3.1. Indoor unit	3
3.2. Remote controller	3
3.3. Inserting batteries.....	5
4. BASIC OPERATIONS	5
5. AIRFLOW SETTINGS	5
5.1. Fan speed setting.....	5
5.2. Airflow direction setting	5
6. TIMER OPERATIONS.....	6
6.1. Weekly timer.....	6
6.2. On timer or Off timer.....	7
6.3. Program timer.....	7
6.4. Sleep timer	7
7. ENERGY SAVING OPERATIONS	7
7.1. Economy operation	7
7.2. Occupancy sensor for energy saving.....	7
7.3. Fan control for energy saving.....	8
8. OTHER OPERATIONS	8
8.1. Powerful operation	8
8.2. Outdoor Unit Low Noise operation	8
8.3. 10°C Heat operation.....	8
9. WLAN control	9
9.1. Usage precautions	9
9.2. Setting to use WLAN control	10
10. SETTINGS ON INSTALLATION.....	12
10.1. Remote controller custom code setting	12
11. CLEANING AND CARE.....	12
12. GENERAL INFORMATION	14
13. OPTIONAL PARTS	14
13.1. Wired remote controller	14
13.2. Multi-split type air conditioner.....	14
14. TROUBLESHOOTING	15

1. SAFETY PRECAUTIONS

To prevent personal injury or property damage, read this section carefully before you use this product, and be sure to comply with the following safety precautions.

Incorrect operation due to failure to follow the instructions may cause harm or damage, the seriousness of which is classified as follows:



WARNING

This mark warns of death or serious injury.



CAUTION

This mark warns of injury or damage to property.



This mark denotes an action that is PROHIBITED.



This mark denotes an action that is COMPULSORY.

Explanation of symbols displayed on the indoor unit or outdoor unit.



WARNING

This symbol shows that this product uses a flammable refrigerant. If the refrigerant is leaked and exposed to an external ignition source, there is a risk of fire.



CAUTION

This symbol shows that the operation manual should be read carefully.



CAUTION

This symbol shows that service personnel should be handling this equipment with reference to the installation manual.



CAUTION

This symbol shows that information is available such as the operation manual or installation manual.



WARNING





- This product shall be installed, operated and stored in a room with a floor area larger than X m².

Amount of refrigerant charge M (kg)	Minimum room area X (m ²)
M ≤ 1.22	-
1.22 < M ≤ 1.23	1.45
1.23 < M ≤ 1.50	2.15
1.50 < M ≤ 1.75	2.92
1.75 < M ≤ 2.0	3.82
2.0 < M ≤ 2.5	5.96
2.5 < M ≤ 3.0	8.59
3.0 < M ≤ 3.5	11.68
3.5 < M ≤ 4.0	15.26



(IEC 60335-2-40)

- This product contains no user-serviceable parts. Always consult authorized service personnel for repairing, installation, and relocation of this product. Improper installation or handling will cause leakage, electric shock, or fire.
- If you notice anything unusual, such as a burning smell or water leak, stop operation of the air conditioner immediately and disconnect it from all power sources, either by turning off the circuit breaker or disconnecting the power plug. Afterwards, contact an authorized service personnel.
- Take care not to damage the power supply cable. If it is damaged, it should be replaced only by authorized service personnel in order to avoid a hazard.
- If a refrigerant leakage is suspected, all naked flames shall be removed or extinguished, and consult authorized service personnel.
- In the event of a thunder storm or any prior sign of a lightning strike, turn off the air conditioner via the remote controller, and refrain from touching the product or the power source to prevent any electrical hazards.
- This product shall be stored in a room without continuously operating ignition sources (for example: open flames, an operating gas appliance, or an operating electric heater).
- This product shall be stored in a well-ventilated area.
- Be aware that refrigerants may not contain an odour.
- This product shall be stored so as to prevent mechanical damage from occurring.
- Disposing of the product shall be done properly, in compliance with national or regional regulations.
- During transportation or relocation of the indoor unit, pipes shall be covered with the wall hook bracket for protection. Do not move this product by holding the indoor unit pipes. (The stress applied to the pipe joints may cause the flammable gas to leak during operation).

WARNING

-  This product is not intended for use by persons (including children) with reduced physical, sensory or mental capabilities, or lack of experience and knowledge, unless they have been given supervision or instruction concerning use of this product by a person responsible for their safety. Children should be supervised to ensure that they do not play with this product.
- Dispose of the packing materials safely. Tear and dispose of the plastic packing bags so that children cannot play with them. There is danger of suffocation if children play with the original plastic bags.
-  Do not install the unit in area filled with mineral oil such as a factory or area containing a large amount of splashed oil or steam such as a kitchen.
- Do not install the unit in a location where it may be potentially exposed to leaked flammable gas or where corrosive gases are present, for example places near a hot spring.
- Do not start or stop the operation of this product by inserting or pulling out the power plug, or by turning on or off the circuit breaker.
- Do not use flammable gases near this product.
- Do not expose yourself directly to the cooling airflow for many hours.
- Do not insert your fingers or any other objects into the air inlet or the air outlet.
- Do not operate with wet hands.
- Do not use means to accelerate the defrosting process or to clean this product, other than those recommended by the manufacturer.
- Do not pierce or burn.
- Do not splash water over the product, to avoid safety hazards.

CAUTION

-  Provide occasional ventilation during use.
- Always operate this product with air filters installed.
- Ensure that any electronic equipment is at least 1 m (40 in) away from this product.
- Disconnect all the power supply when not using this product for extended periods.
- After a long period of use, ensure to get the mounting of the indoor unit checked to prevent this product from falling down.
- The airflow direction and the room temperature should be carefully considered when you use this product in a room with infants, children, elderly, or sick persons.
- Keep the surroundings of the outdoor unit clean and tidy, and do not place items around it. Any objects blocking or entering from the outlet ports may cause product malfunction.
-  Do not direct the airflow at fireplaces or heating appliances.
- Do not block or cover the air inlet and the air outlet.
- Do not apply any heavy pressure to the radiator fins.
- Do not climb on, place objects on, or hang objects from this product.
- Do not place any other electrical products or household belongings under this product. Dripping condensation from this product might get them wet and may cause damage or malfunction of your property.

CAUTION

-  Do not use this product for the preservation of food, plants, animals, precision equipment, artwork, or other objects. This may cause quality deterioration of those items.
- Do not expose animals or plants to the direct airflow.
- Do not drink the drainage from the air conditioner.
- Do not pull the power supply cable.
- Do not touch the aluminum fins of the heat exchanger built-in this product to avoid personal injury when you maintain the unit.
- Do not stand on unstable steps when operating or cleaning this product. It may overturn and can cause injury.



This product contains fluorinated greenhouse gases.

2. PREPARATION

WARNING

-  Take care to prevent infants and young children from accidentally swallowing the batteries.

CAUTION

-  If leaking battery fluid comes in contact with your skin, eyes, or mouth, immediately rinse with plenty of clean water, and consult your physician.
- Exhausted batteries must be removed immediately and be disposed of according to the local laws and regulations of your region.
-  Do not attempt to recharge dry batteries.
- Do not use dry batteries that have been recharged.

Indoor unit accessories

Check that the following accessories are included.

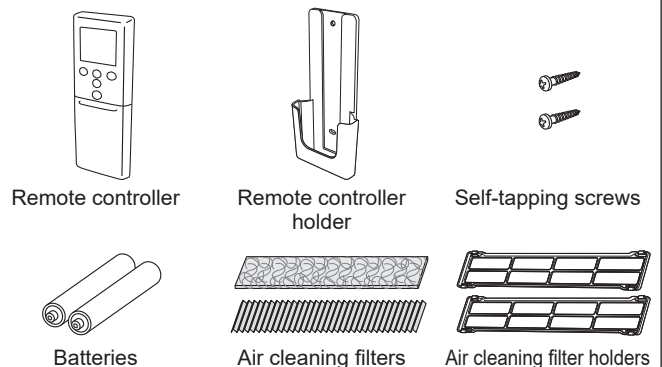

How to use the remote controller holder

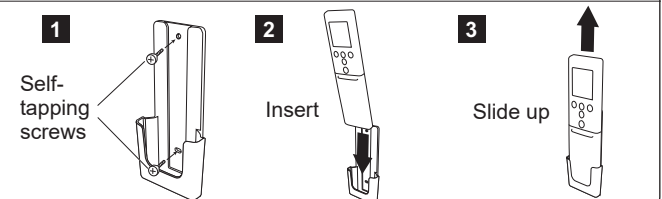

3. NAME OF PARTS

CAUTION

- For appropriate signal transmission between the remote controller and the indoor unit, keep the signal receiver away from the following items:
- Direct sunlight or other strong lights
 - Flat-panel television screen
- In rooms with instantaneous fluorescent lights, such as inverter type ones, the signal may not be transmitted properly. In such a case, consult the store of purchase.

3.1. Indoor unit

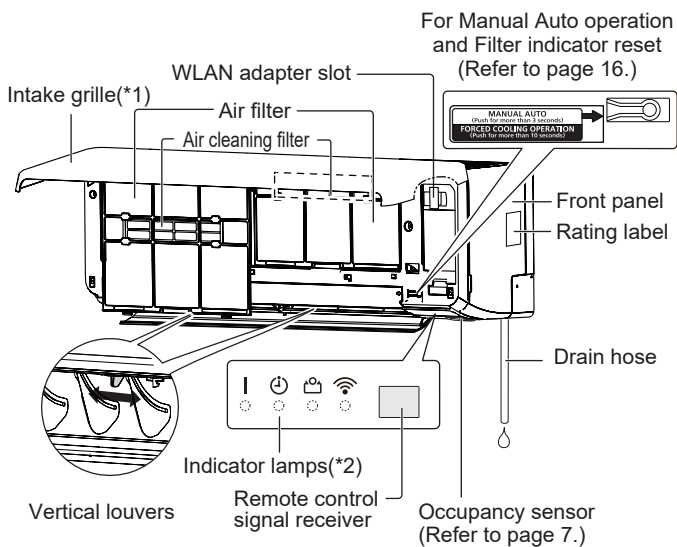

*1: Before starting the operation, make sure that the intake grille is closed completely. Incomplete closing may affect the proper function or performance of the product.

*2: Indicator lamps light in the following conditions.

	Name	Color	Operation or condition
	Operation	Green	Normal operation
🕒	Timer	Orange	Timer operation
🏠	Economy	Green	Economy operation 10°C Heat operation
📶	WLAN	Orange	Wireless LAN control is active.

3.2. Remote controller

When you use the optional remote controller, the appearance and the operation procedure may differ.

For details, refer to the operation manual of each remote controller.

CAUTION

- To prevent malfunction or damage of the remote controller:
 - Place remote controller at where will not be exposed to direct sunlight or excessive heat.
 - Remove batteries if the product is not going to be used for an extended period.
 - Obstacles such as a curtain or wall between the remote controller and the indoor unit may affect the appropriate signal transmission.
 - Use the remote control in the same room as the indoor unit.
 - Remove the protective film before use.
 - Keep the remote control out of reach of infants and young children.
 - Keep the batteries out of reach of infants and young children.
- Do not apply strong shocks to the remote controller.
Do not pour water on the remote controller.

Remote controller display

In this section, all the possible indicators are displayed for description. In actual operation, the display is linked with the button operation, and only shows the necessary indicators for each setting.

For 10°C Heat operation Refer to page 8.

🏠 10°C HEAT
○ Activates the 10°C Heat operation.

For Basic operations Refer to page 5.

🔌 Starts or stops the air conditioner operation.

MODE Changes the operation mode. *|

TEMP.
⬆️
⬇️ Adjusts the setting temperature. *|

For Energy saving operations Refer to page 7.

🏠 ECONOMY Activates or deactivates the Economy operation. |

ENERGY SAVING PROGRAM
SENSOR Activates or deactivates the Energy saving program that uses the occupancy sensor.

For Outdoor Unit Low Noise operation ... Refer to page 8.

OUTDOOR UNIT
LOW NOISE Activates or deactivates the Outdoor Unit Low Noise operation.

Do not press this button in normal use. It starts the test run (for use by authorized service personnel only).
NOTE: If the test run starts unintentionally, press 🔌 to quit the test run.

- * : The setting must be done while the setting screen is displayed for each function.
- | : The button is controllable only when the air conditioner is operating.
- 📶 : The instruction is relating to the wireless LAN control.

Signal transmitter

Aim at the signal receiver of the indoor unit properly.

- Operating range is approximately 7 m.
- [▲] will appear when the signal is transmitted.
- The indoor unit will emit a beep when it receives the signal properly. If there is no beep, press the button again.

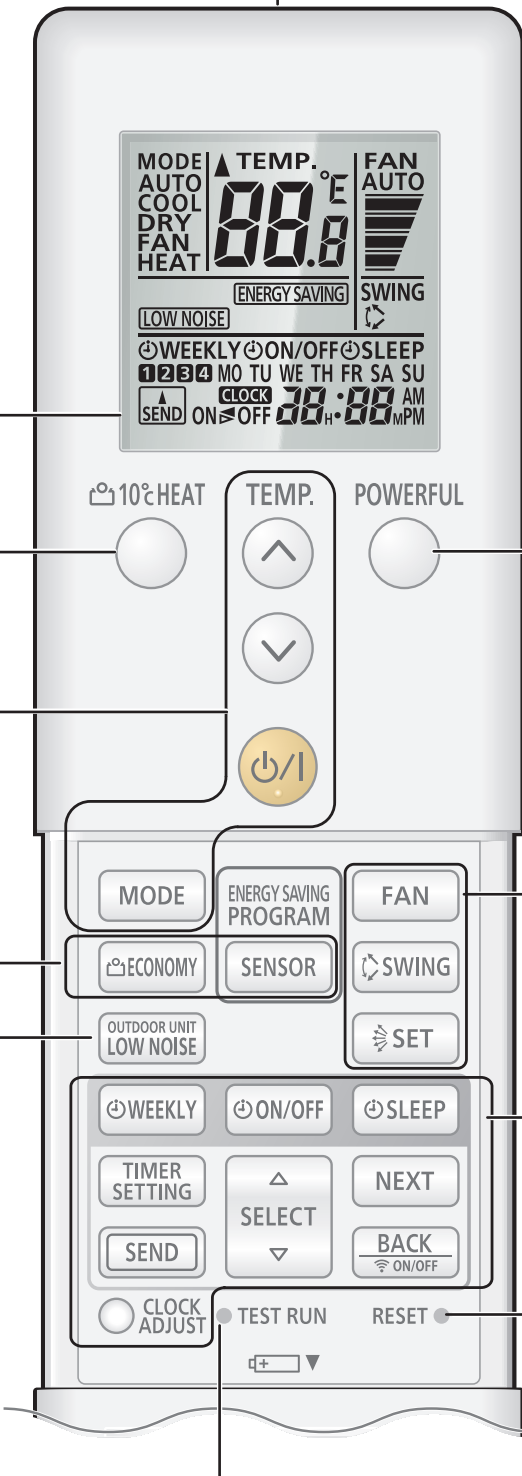

For Powerful operation Refer to page 8.

POWERFUL Activates or deactivates the Powerful operation. |

For Airflow settings Refer to page 5.

FAN Controls the fan speed. *|

SWING Starts or stops the automatic Swing operation. |

SET Controls the up/down airflow direction. |

For Timer operations Refer to page 6.

WEEKLY Activates or deactivates the Weekly timer.

ON/OFF Activates or deactivates the On timer, Off timer, or Program timer.

SLEEP Activates or deactivates the Sleep timer.

TIMER SETTING Starts the timer setting.

SEND Sends the timer or clock setting to the indoor unit.

By pressing and holding, enters the wireless LAN setting mode. (Refer to page 11.) 📶

NEXT Forwards the timer or clock setting to the next step.

Returns the timer or clock setting to the previous step.

BACK ON/OFF By pressing and holding, activates or deactivates the wireless LAN control. (Refer to page 11.) 📶

SELECT Adjusts the value of the timer or clock settings.

CLOCK ADJUST Starts the clock setting.

After replacing batteries

RESET Press this button as shown in the following figure. Use the tip of a ballpoint pen or other small object.



3.3. Inserting batteries

Battery type: R03/LR03/AAA x 2

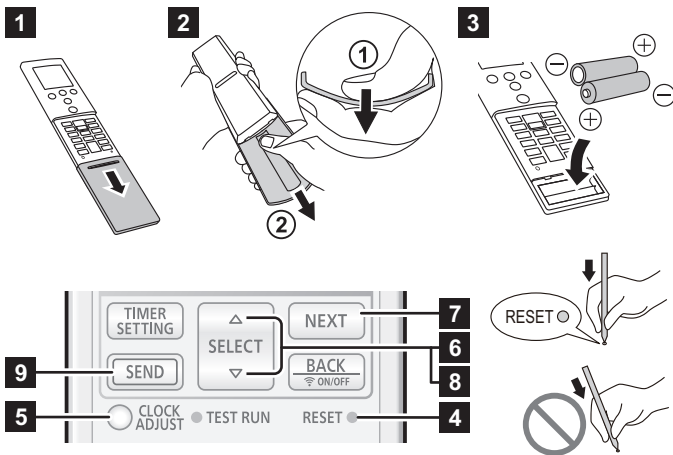

- 1** Pull the cover in the direction of the arrow and open it until it is trapped.
- 2** Remove the cover.
 - ① Turn the remote controller over and push the back side of the cover and remove the claws by curving the cover.
 - ② Pull in the direction of the arrow while curving the cover.
- 3** Put batteries as shown in the figure above.
- 4** Press this button as shown in the figure above. Use the tip of a ballpoint pen or other small objects.
- 5** Press **CLOCK ADJUST** to start the setting for day of the week and the clock.
- 6** Press **SELECT** ($\Delta \nabla$) to set day of the week (Monday to Sunday).
- 7** Press **NEXT** to continue.
- 8** Press **SELECT** ($\Delta \nabla$) to set the clock. Press the buttons to change the clock by a minute. Press and hold the buttons to change the clock by 10 minutes. * By pressing **TEMP.** ($\odot \ominus$), the time indicator can be changed from a 12-hour to a 24-hour clock.
- 9** Press **SEND** to complete the setting. Be close to the indoor unit. If you press the button from a distance, settings may not be properly sent.
- 10** Install and close the cover.

NOTES:

- Use the specified type of batteries only.
- Do not mix different types or new and used batteries together.
- Batteries can be used for about 1 year in ordinary use.
- If the remote control range noticeably shortens, replace the batteries and press **RESET** \odot as shown in the figure above.

4. BASIC OPERATIONS

3 steps to start operation

- 1.** Press \odot/\ominus to start or stop the operation.
- 2.** Press **MODE** to select the operation mode. The operation mode changes as follows.



- 3.** Press **TEMP.** ($\odot \ominus$) to set the desired temperature. The temperature changes by 0.5°C increments.

Temperature setting range	
Auto/Cooling/Dry	18.0°C to 30.0°C
Heating	16.0°C to 30.0°C

NOTES:

- In the Cooling mode, the indoor unit fan may stop from time to time to perform Fan control for energy saving that enables power-saving operation by stopping the rotation of the indoor unit fan when the outdoor unit is stopped. In the initial setting, this function is activated. To deactivate the function, refer to "7.3. Fan control for energy saving".
- In the Cooling or Dry mode, set the temperature lower than the current room temperature.
- In the Heating mode,
 - set the temperature higher than the current room temperature.
 - at the beginning of the operation, the indoor unit fan rotates at a very low speed for 3 to 5 minutes.
 - the Automatic defrosting operation overrides the Heating operation when necessary.
- In the Fan mode, temperature control is not available.

Temperature unit switching

- 1.** If the air conditioner is operating, press \odot/\ominus to stop the operation.
- 2.** Press and hold **TEMP.** (\odot) for more than 5 seconds. The current temperature unit will be displayed. (Factory setting: °C)
- 3.** Press **TEMP.** ($\odot \ominus$) to switch the temperature unit. (°C \leftrightarrow °F)
- 4.** Press \odot/\ominus to finish the setting. If you do not press the button for 30 seconds, the displayed temperature unit will be set.

5. AIRFLOW SETTINGS

5.1. Fan speed setting

- ☞ Press **FAN** to control the fan speed. The fan speed changes as follows.



When **AUTO** is selected, the fan speed depends on the operating condition.

To increase the air cleaning effect, set the fan speed to High.

5.2. Airflow direction setting

For details of the airflow ranges, refer to "Airflow direction range."

Up/down airflow direction setting

- ☞ Press **SET** to adjust the up/down airflow direction.

Left/right airflow direction setting

CAUTION

⚠ Before you adjust the left/right airflow direction, make sure that the horizontal louver has been stopped completely.

- ☞ Adjust two knobs of the vertical louvers by hand.

Swing operation setting

Press **SWING** to start/stop the Swing operation.

NOTE: The Swing operation may stop temporarily when the indoor unit fan is rotating at a very low speed or is stopped.

Airflow direction range

Up/down airflow direction

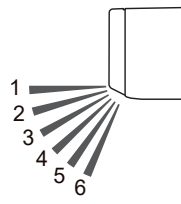

Change by SET	
Cooling, Dry	1 ↔ 2 ↔ 3 (↔ 4 ↔ 5 ↔ 6)
Heating, Fan	1 ↔ 2 ↔ 3 ↔ 4 ↔ 5 ↔ 6
Swing operation by SWING	
Cooling, Dry	1 ↔ 4
Heating	3 ↔ 6
Fan *	1 ↔ 4 or 3 ↔ 6

* The Swing operation range depends on the airflow direction set before the Swing operation.

NOTES:

- Do not adjust the louver by hand.
- In the Auto or Heating mode, the airflow direction stays position 1 for a while from the start of the operation.
- In the Cooling or Dry mode, the downward airflow can change to the upper as follows. This feature is to prevent condensation from dripping and damaging your property.
Condition: Position 4-6 keeps for 30 minutes
Airflow adjusted to: Position 3
- When using the mobile app, the up/down airflow can be selected from 4 positions.

6. TIMER OPERATIONS

NOTE: When [**⏰**] indicator on the indoor unit blinks, set the clock and timer again. This blinking shows that the internal clock go wrong due to an interruption of the power supply. (Refer to page 14.)

Timer setting procedure

Before setting the timer, adjust the clock. (Refer to "3.3. Inserting batteries").

- Press **TIMER SETTING**.
⏰WEEKLY on the remote controller display will blink.
- Press **SELECT** (△▽) to choose timer operation.
The timer operation will change as follows:

⏰WEEKLY	Weekly timer	Enables you to set operation schedules up to 4 setting for each day of the week.
⏰ON/OFF [ON]	On timer	Starts the operation at your desired time.
⏰ON/OFF [OFF]	Off timer	Stops the operation at your desired time.
⏰ON/OFF [ON/OFF]	Program timer	Operates as a combination of the On timer and Off timer.
⏰SLEEP	Sleep timer	Supports your comfortable sleep by moderating the air conditioner operation gradually.

- Press **NEXT**.
- Set each timer operation.
For details, refer to the following instructions of each timer setting.
- Press **SEND** to complete the timer setting.
Be close to the indoor unit.

- To cancel the timer setting during the procedure, press **TIMER SETTING** again.

6.1. Weekly timer

Setting details

- Select Weekly timer in step 2 of "Timer setting procedure".
- Press **SELECT** (△▽) to select the program number and the day of the week.
Selected program number (1 to 4) and the day of the week will blink.

MO	Monday
TU	Tuesday
WE	Wednesday
TH	Thursday
FR	Friday
SA	Saturday
SU	Sunday

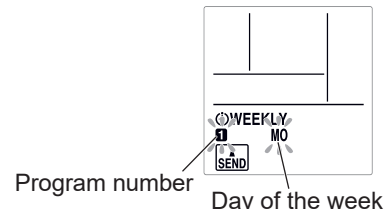

- Press **NEXT**.
- Press **SELECT** (△▽) to choose the timer operation.

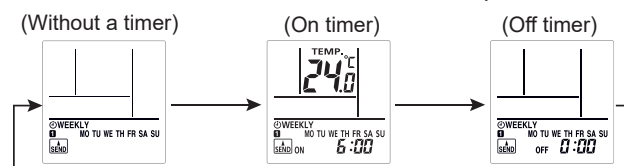

- Press **NEXT**.
* When you chose "Without a timer" in step 4, the setting display will return to step 1.
- Press **SELECT** (△▽) to set on time or off time.
- Press **NEXT**.
* When you chose "Off timer" in step 4, the setting display will return to step 1.
- Press **SELECT** (△▽) to set the temperature.

Temperature setting range

Auto, Cooling,	18.0°C to 30.0°C
or Dry mode:	*Even if you set to 10.0°C, 16.0°C to 17.5°C, the air conditioner will run at 18.0°C.
Heating mode:	10.0°C or 16.0°C to 30.0°C

- Press **NEXT**.
The setting display will return to step 1.
- Press **SEND** to complete the setting.
Be close to the indoor unit.
NOTE: [**⏰**] indicator on the indoor unit will not turn on even if the setting is complete.

- If you want to return the previous step, press **BACK** (⏪).
- To check the schedule, use **SELECT** (△▽) to browse the Weekly timer settings in step 2.
To finish checking, press **TIMER SETTING**.
- To deactivate the Weekly timer, press **⏰WEEKLY** while **⏰WEEKLY** is shown on the remote controller display.
The indicator will disappear.

NOTES:

- The operation modes will be the same as the mode at the last time operation was stopped, so Cooling → Heating → Cooling → Heating type of operations cannot be set automatically.
- If you set the On timer and Off timer on the same time, the On timer will work.
- If two On timers are set on the same time, the air conditioner will run in the order of the program number.
- You cannot use the Weekly timer and the other timers simultaneously.
If you use the On/Off timer, the Program timer, or the Sleep timer while the Weekly timer is activated, the Weekly timer will be deactivated.
In such a case, activate the Weekly timer after the other timer finishes.
- If the wired remote controller (optional) is connected, this function is restricted.

Examples of Weekly timer

Example 1

	7:00	9:00	11:00	17:00	23:00
Monday to Friday	Program 1 On 26°C Wake up	Program 2 Off Leave for work		Program 3 On 28°C Come back home	Program 4 Off Go to sleep
Saturday	(No timer settings)				
Sunday	(On)	Program 1 Off (On)	Program 2 Off (On)	Program 3 Off (On)	Program 4 Off (On)

Example 2: You can specify temperature settings using the On timer in the Weekly timer.

7:00	9:00	17:00	23:00
Program 1 On 28°C	Program 2 On 26°C	Program 3 On 27°C	Program 4 On 28°C

6.2. On timer or Off timer

- Select On timer or Off timer in step 2 of "Timer setting procedure".
- Press **SELECT** ($\triangle \nabla$) to set on time or off time.
Pressing the button: The time will change by +5/-5 minutes.
Pressing and holding the button: The time will change by +10/-10 minutes.
 - To deactivate the On/Off timer, press **ON/OFF** while **ON/OFF** is shown on the remote controller display. The indicator will disappear.

6.3. Program timer

- Set On timer and Off timer. (Refer to "6.2. On timer or Off timer").
- Select Program timer in step 2 of "Timer setting procedure".
The timer whose setting time is closer to the current time works first. The order of the timer operation is displayed as follows:

Timer	Indicator on the remote controller display
On→Off timer	ON▷OFF
Off→On timer	ON◀OFF

NOTE: You can set the Program timer only within a span of 24 hours.

6.4. Sleep timer

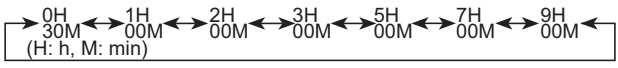
- Select Sleep timer in step 2 of "Timer setting procedure".
- Press **SELECT** ($\triangle \nabla$) to set the time until the operation stops.
Each time you press the button, the time changes as follows:

- To deactivate the Sleep timer, press **SLEEP** while **SLEEP** is shown on the remote controller display. The indicator will disappear.

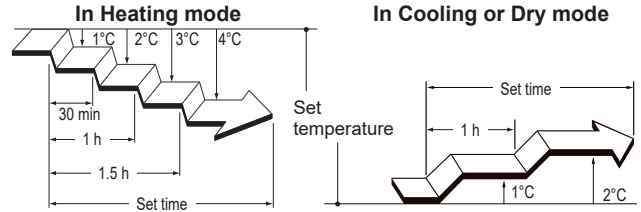
During the Sleep timer operation, the setting temperature changes as the following figure.



After the set time has elapsed, the air conditioner operation turns off.

7. ENERGY SAVING OPERATIONS

7.1. Economy operation

It saves more electricity than other operation modes by changing the set temperature to a moderate setting.

- Press **ECONOMY** to activate/deactivate the Economy operation.

[**ECONOMY**] indicator on the indoor unit will turn on.

Operation mode	Room temperature
Cooling/Dry	Few degrees higher than the set temperature
Heating	Few degrees lower than the set temperature

NOTES:

- In the Cooling, Heating, or Dry mode, the maximum output of this operation is approximately 70% of the usual operation.
- This operation cannot be performed during the temperature monitoring by the Auto mode.

7.2. Occupancy sensor for energy saving

WARNING

- Do not use this function when there are only infants, children, elderly, or sick persons in the room.

CAUTION

- Do not use this function in server rooms or other places where there is no one in the room.
- Do not place large objects near the occupancy sensor. Also keep heating units outside the sensor's detection area.

When no one is in the room, the air conditioner operates moderately to prevent waste of electricity.

(This function is activated at the time of purchase.)

- To change the setting, press **SENSOR**.

While the Energy Saving program is activated, **ENERGY SAVING** on the remote controller display will turn on.

NOTES:

- The following operations will override the Energy Saving program.
 - Sleep timer operation
 - 10°C Heat operation
- The Energy Saving program may not work when the room temperature is very different from the set temperature, such as when immediately after starting the operation.

■ Details on Energy Saving program

The occupancy sensor on the indoor unit detects the movement of persons.

If there is no one in the room for approximately 20 minutes, the temperature will be adjusted moderately.

When someone comes back into the room, the air conditioner reverts to the original settings.

Operation mode	Room temperature (When there is no one there)
Cooling/Dry	Higher than the set temperature (Max. +2°C)
Heating	Lower than the set temperature (Max. -4°C)
Auto	Depending on the operating mode (Cooling/ Heating/ Dry).

Detection range of the occupancy sensor

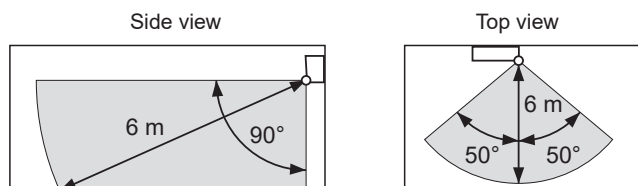

NOTE: Since the occupancy sensor detects infrared light given out by people, the detection may be incorrect in the following situations.

Situations in which the sensor may detect no one in the room, even when there is someone there:

- When the room temperature is high and the difference with people's body temperature is small. (Such as when the temperature is 30°C or higher in summer.)
- When someone in the room do not move for a long time.
- When someone is hidden behind a sofa, other furniture, glass, or in similar situations.
- When someone is wearing extremely thick clothing and turn their backs on the sensor.

Situations in which the sensor may detect people in the room, even when there is no one there

- When there is a dog or a cat moving around in the room.
- When wind is moving curtains or plants.
- When heating units, humidifiers, or electric appliances such as oscillating electric fans are operating.

7.3. Fan control for energy saving

In the Cooling operation, when the room temperature reaches the set temperature, the indoor unit fan rotates intermittently to save power. (This function is activated at the time of purchase.)

To change the setting, use the following steps;

1. Press until the indicators on the remote controller turn off.
2. Press and hold **FAN** for more than 5 seconds.
The **FE** and the current status will appear.
ON : Activated
OFF : Deactivated
3. Press **TEMP.** () to switch the status.
4. Press to send the setting to the indoor unit.
The display will return to the original screen.

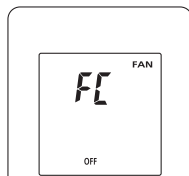

NOTE: If you do not press any buttons for 30 seconds after **FE** is displayed, **FE** will turn off. In this case, repeat the setting from step 2.

8. OTHER OPERATIONS

8.1. Powerful operation

In the Powerful operation, the air conditioner will operate at maximum power and strong airflow to cool down or warm up the room quickly.

NOTE: In the multi-split connection, this function cannot be used.

- ☞ Press **POWERFUL** to activate/deactivate the Powerful operation.
When activated, the indoor unit will emit 2 short beeps.
When deactivated, the indoor unit will emit 1 short beep.

The Powerful operation will be turned off automatically in the following situations:

- The Powerful operation runs for a certain amount of time, and the room temperature reaches the set temperature in the Cooling, Dry, or Heating mode.
- 20 minutes after the Powerful operation has started.

NOTES:

- The airflow direction and the fan speed are controlled automatically.
- The Powerful operation cannot be performed simultaneously with the Economy operation.
- The Powerful operation overrides the following operations. If the following operations are set, they will start after the Powerful operation finishes.
 - Outdoor Unit Low Noise operation
 - Energy Saving program
- If the wired remote controller (optional) is connected, this function is restricted.

8.2. Outdoor Unit Low Noise operation

The Outdoor Unit Low Noise operation lowers noise from the outdoor unit. During this operation, the rotation number of the compressor decreases, and the outdoor unit fan rotates slowly.

NOTE: In the multi-split connection, this function cannot be used.

- ☞ Press **OUTDOOR UNIT LOW NOISE** to activate/deactivate the Outdoor Unit Low Noise operation.
While the Outdoor Unit Low Noise operation is activated, **LOW NOISE** on the remote controller is displayed.
The setting is preserved even if the air conditioner is turned off.

NOTES:

- This operation cannot be performed simultaneously with the Fan mode, Dry mode, and Powerful operation.
- If the wired remote controller (optional) is connected, this function is restricted.

8.3. 10°C Heat operation

10°C Heat operation maintains the room temperature at 10.0°C so as to prevent the room temperature from dropping too low.

- ☞ Press **10°C HEAT** to activate the 10°C Heat operation.
The indoor unit will emit 1 short beep and indicator on the indoor unit will turn on.

- ☞ Press to turn off the air conditioner.
 indicator will turn off.

NOTES:

- During the 10°C Heat operation, only **SET** is valid.
- When the room temperature is warm enough, this operation will not perform.
- If the wired remote controller (optional) is connected, this function is restricted.

9. WLAN control

This operation manual describes only the setting procedure of the remote controller.

For how to operate the mobile app, refer to the operation manual of the mobile app.

NOTES:

- The air conditioner settings from the mobile app will not be reflected in the wireless remote controller.
- It will not be possible to operate and monitor by the mobile app while the power supply of the air conditioner is disconnected (via breaker or plug).
- The room temperature will be displayed in the mobile app during operation. However, the displayed room temperature may not be correct depending on the situation in the room or the air conditioner operating status. Use this only as a reference.
- If the mobile app and remote controller settings differ, the latest operation performed will take priority.
- If timer settings are done from the mobile app and from the wireless or wired remote controller, both timer settings will be active.

The contents of wireless LAN label are necessary for wireless LAN setup.

Write down the SSID and the PIN code to the following table.

Open the intake grille.

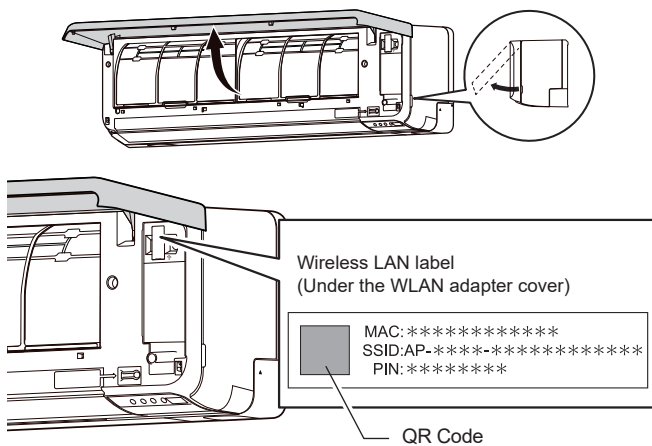

*The layout of the wireless LAN label may differ by the part or model.

Information on WLAN adapter

SSID	
PIN	

Wireless LAN-compatible standard	IEEE 802.11 b/g/n
Frequency bands	2.4 GHz (in the U.S. or Canada: 1 ch to 11 ch) (in the other regions: 1 ch to 13 ch)
Maximum radio-frequency power	40 mW
Wireless LAN security	Open WEP WPA (PSK) WPA2_Personal (PSK) WPS for same-LAN Registration

“AIRSTAGE Mobile” is a trademark of FUJITSU GENERAL LIMITED.

Android and Google Play are registered trademarks of Google LLC.

App Store is a service mark of Apple Inc., registered in the U.S. and other countries.

IOS is a trademark or registered trademark of Cisco in the U.S. and other countries and is used under license.

“QR Code” is a registered trademark of DENSO WAVE INCORPORATED.

9.1. Usage precautions

Usage precautions for wireless LAN control

WARNING

- ⊘ Do not repair, disassemble or remodel the WLAN adapter.
- Do not get the WLAN adapter wet or use it in locations with lots of moisture.
- Do not operate with wet hands.
- Do not install the WLAN adapter in locations where the use of wireless equipment is prohibited (e.g., hospitals).
- Do not use the WLAN control in a room where young children or people with physical disability are present.
- Do not use the WLAN control near persons with a pacemaker or similar devices.
- Do not use the WLAN control near automatic control equipment (e.g., automatic doors and fire alarms).

CAUTION

- ⓘ When cleaning the air conditioner, be sure to stop the operation and turn off the power. Otherwise, there is a risk of electric shock or injury.
 - ⊘ Do not stand on slippery, uneven, or unstable surfaces when install the WLAN adapter.
 - Do not put fingers, sticks, etc., in the connection part of the WLAN adapter and the insertion slot of the air conditioner.
 - The WLAN adapter is not a USB device. Do not connect to other than specified equipment. Otherwise, there is a risk of malfunction or fire.
- When you use the WLAN control, it will become possible to operate the air conditioner from locations where you cannot see it directly. This means that people in the room may be exposed to the unintended operation of the air conditioner. Check the condition of the room before using the WLAN control.
 - Be sure to check regularly that dust has not built up around the connection slot of the air conditioner for the WLAN adapter.
 - Be sure to check in advance that there are no malfunctions of the air conditioner.
 - Make sure that the airflow from the air conditioner will not cause any adverse effects. Objects may fall down causing personal injury, fire, or damage to property.
 - If you know that there are people in the vicinity of the air conditioner, inform them in advance that you will operate it from a distant location. Sudden operation of the air conditioner may surprise a person and cause the person to fall down or tumble if the person is on a step, ladder, etc. Furthermore, rapid changes of the room temperature may cause deterioration in a person's physical condition. Do not use the WLAN control when there are people in the room who are not able to control the temperature by themselves (For example, infants, children, those with physical disabilities, elderly or sick persons.).
 - Fully understand the reserved timer settings and other operations before using the WLAN control. Unexpected operation of the air conditioner may cause deterioration in a person's physical condition or an adverse effect on animals or plants.

- Frequently check the settings and operating situation of the air conditioner when using the WLAN control from a distant location. Rapid changes of the room temperature may cause deterioration in a person's physical condition or an adverse effect on animals or plants.
- If you operate the air conditioner by the WLAN control, the indicator lamps and reception sounds of the air conditioner do not work.
- If there is bad reception between the WLAN adapter and the access point, adjusting the access point position or direction of the antenna may improve the reception. It may also be possible to improve reception by moving the access point closer to the WLAN adapter or using a wireless LAN repeater.

Radio wave and security precautions

When you use a wireless LAN, there are precautions that you must follow in relation to radio waves, personal information, and so on. To use the WLAN control correctly, be sure to read the following precautions and the operation manual of the wireless LAN equipment you are using. We will assume no responsibility, unless legal liability is recognized, in regards to failures, other defects and damages incurred by use of the WLAN adapter that occur through incorrect use or during use by yourself or a third party.

Radio wave usage precautions



CAUTION



- Changes or modifications not expressly approved by the party responsible for compliance could void the user's authority to operate the equipment. This transmitter must not be co-located or operated in conjunction with any other antenna or transmitter.
- This equipment complies with FCC/IC radiation exposure limits set forth for an uncontrolled environment and meets the FCC radio frequency (RF) Exposure Guidelines and RSS-102 of the IC radio frequency (RF) Exposure rules. This equipment should be installed and operated keeping the radiator at least 20 cm or more away from person's body. (UTY-TFSXH3 [AP-WH3E]/UTY-TFSXH4 [AP-WH4E] model conforms to IC (Industry Canada) standard.)

NOTES:

- This device complies with Part 15 of FCC Rules and Industry Canada license-exempt RSS standard(s). Operation is subject to the following two conditions:
 - (1) this device may not cause interference, and
 - (2) this device must accept any interference, including interference that may cause undesired operation of this device. (UTY-TFSXH3 [AP-WH3E]/UTY-TFSXH4 [AP-WH4E] model conforms to IC (Industry Canada) standard.)
- This equipment has been tested and found to comply with the limits for a Class B digital device, pursuant to part 15 of the FCC Rules.
- Do not use the WLAN adapter in the following locations. Using the WLAN adapter in such locations may cause communications becoming unstable or not possible.
 - Near wireless communication equipment that uses the same frequency band (2.4 GHz) as the WLAN adapter.
 - In places where there are magnetic fields from equipment such as microwave ovens, or static electricity or radio wave interference occurs. (Radio waves may not reach depending on the environment.)

Personal Information (Security-related) Usage Precautions

- There is a possibility of interception if you use wireless LAN equipment due to the use of radio waves regardless of whether you use encryption or not.

- Wireless LAN uses radio waves to exchange information between the WLAN adapter and the access point. This means it has the advantage of freely being able to make a LAN connection if within reach of radio waves. On the other hand, if the radio waves are within a certain range, they will reach all locations beyond obstacles (e.g., walls). Therefore, it is possible your communications may be intercepted and read or illegally intruded upon.
- Do not connect to equipment and networks which you are not authorized to use when setting up your wireless connection.
- Initialize the settings of the WLAN adapter when disposing of it or transferring it to a third party.

Others

- Use the WLAN adapter as regular wireless LAN equipment.
 - Do not use the WLAN adapter in hospitals or in/near locations with medical equipment.
 - Do not use the WLAN adapter within an aircraft.
 - Do not use the WLAN adapter near electronic equipment that handles high-precision control or weak signals. Examples of electronic equipment to be careful of: Hearing aids, pacemakers, fire alarms, automatic doors, and other automatic control equipment
- This is not a guarantee of wireless connection and performance with all wireless routers and in all residential environments. Radio waves may not reach or may be interrupted in the following situations.
 - Use in buildings made from concrete, rebar, or metal
 - Installation near obstacles
 - Interference with wireless communication equipment using the same frequency
 - Places where there are magnetic fields from equipment such as microwave ovens, or static electricity or radio wave interference occurs
- Install and setup the WLAN adapter only after reading the operation manual of the access point.

9.2. Setting to use WLAN control

Step 1. Mobile app installation

1. Open "Google Play" or "App Store" depending on the type of your smartphone.
2. Search for "AIRSTAGE Mobile."
3. Install the mobile app following the instructions on your screen.

NOTE: If you cannot find the application software (mobile app), it is currently not available in your region.

Step 2. User registration

1. Open the installed mobile app.
2. Register the user by following the instructions of the mobile app.

Step 3. Air conditioner registration (pairing of WLAN adapter)

NOTES:

- Before starting this setting, wait for 60 seconds or more after the power supply is connected to the air conditioner (via breaker or plug).
- Check that the smartphone is linked to the access point you are connecting to the air conditioner. The setting does not work if it is not connected to the same access point.
- To control 2 or more air conditioners with the same smartphone, repeat the setup of the chosen mode.

- ☞ Scan the QR Code on the WLAN adapter to use the automatic entry of the SSID and the PIN of the WLAN adapter. Refer to page 9 for the location of the QR Code.
- ☞ Register the air conditioner by following the instructions of the mobile app.









<How to access the online manual>

1. Sign in to the mobile app.
2. Tap the Settings tab.
3. Tap [Support].
4. Tap [Manual].

When the registration is completed, [] indicator on the indoor unit will turn on.

Temporary deactivation of WLAN

NOTE: If you do not press any buttons of the remote controller for 60 seconds, the remote controller display will return to the original display.

1. If the air conditioner is operating, press  to stop the operation.
2. Press and hold  on the remote controller for more than 5 seconds.
 will be displayed on the remote controller display.
3. Select **OFF** using  ( ) on the remote controller. (*1)
4. Press  .
[] indicator on the indoor unit will turn off.

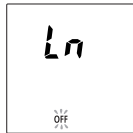
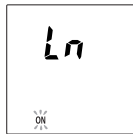

*1: If you want to activate WLAN again, select **ON** in step 2.

Initialization (reset)

Initialize (reset) the WLAN adapter in the following situations:











- Changing the access point
- Disposing of this product
- Transferring this product to a third party

Unregister the air conditioner

Unregister the air conditioner by using the mobile app. (Refer to the operation manual of the mobile app for details.)

Initialization of the WLAN adapter

NOTE: If you do not press any buttons of the remote controller for 60 seconds, the remote controller display will return to the original display.

1. If the air conditioner is operating, press  to stop the operation.
2. Press and hold  on the remote controller for more than 5 seconds.
 will be displayed on the remote controller display.
3. Select  using  ( ) on the remote controller.
4. Press  .
 on the remote controller display will blink.
5. Press  .
[] indicator on the indoor unit will turn off after blinking fast.

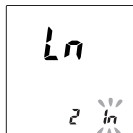
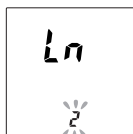
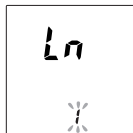

To continue use

If you or a third party wishes to continue the use of the WLAN adapter, follow the procedures in "Air conditioner registration (pairing of WLAN adapter)" to reconnect to a different access point.

NOTE: WLAN setup is not possible if the previous owner did not unregister or initialize the WLAN adapter. In this case, contact your authorized service personnel.

Firmware update

! CAUTION

Do not pull out the power plug nor turn off the circuit breaker during the firmware update of the indoor unit or WLAN adapter. It may cause malfunction.

For WLAN adapter

The firmware of the WLAN adapter may be updated automatically. During the updating, you cannot operate the air conditioner from the mobile app. It will take for a maximum of 5 minutes.

For indoor unit

The firmware of the indoor unit may be updated. You can set the schedule of the updating or update the firmware manually from the mobile app. For details, refer to the operation manual for the mobile app.

During the updating, the indicator lamps flash and the air conditioner stops the operation. (Refer to "State of indicator lamps".) It will take for a maximum of 30 minutes.

Removing WLAN adapter

! CAUTION

- Be sure to turn off the power supply of the air conditioner when installing or removing the WLAN adapter to avoid the risk of electric shock.
- Do not put fingers, sticks etc. in the connection part of the WLAN adapter and the connection slot of the indoor unit. Otherwise, electric shock or damage to this product may occur.
- Do not standing on an unstable platform when installing or removing the WLAN adapter to avoid injury.

1. Be sure to turn air conditioner off and disconnect all the power supplies.
2. Open the intake grille.

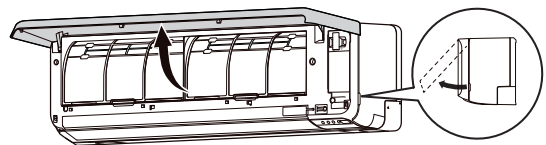

3. Open the WLAN adapter cover until it snaps.

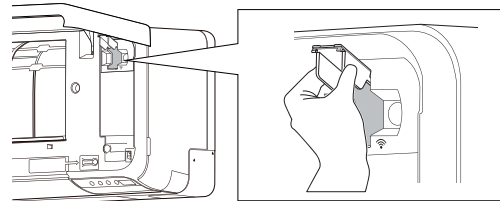

- Remove the WLAN adapter from the connection slot of the indoor unit in the direction as shown in the figure.

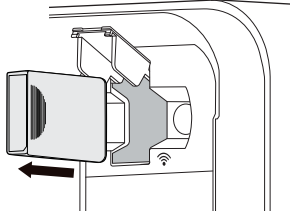

- Close the WLAN adapter cover and the intake grille.

10. SETTINGS ON INSTALLATION

10.1. Remote controller custom code setting

By setting custom codes of the indoor unit and the remote controller, you can specify the air conditioner which the remote controller controls. When two or more air conditioners are in the room and you wish to operate them separately, set the custom code (4 selections possible).

NOTE: If custom codes are different between the indoor unit and the remote controller, the indoor unit cannot receive a signal from the remote controller.

How to set the remote controller custom code

- Press **(ON)** until only the clock is displayed on the remote controller display.
- Press and hold **(MODE)** for more than 5 seconds.
The current custom code will be displayed (initially set to A).
- Press **(TEMP)** (⊙/⊙) to change the custom code between A (A) ↔ B (b) ↔ C (c/ε) ↔ D (d).
* Match the custom code on the display to the air conditioner custom code.
- Press **(MODE)** again.
The custom code will be set.
The display will return to the clock display.

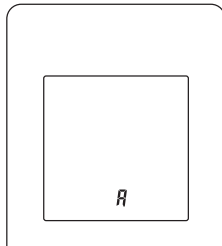

- To change the air conditioner custom code, contact authorized service personnel (initially set to A).
- If you do not press any buttons for 30 seconds after the custom code is displayed, the display returns to the clock display. In this case, repeat the setting from step 2.
- Depending on the remote controller, the custom code may return to A when replacing the batteries. In this case, reset the custom code as necessary. If you do not know the air conditioner custom code, try each code until you find the code which operates the air conditioner.

11. CLEANING AND CARE

CAUTION

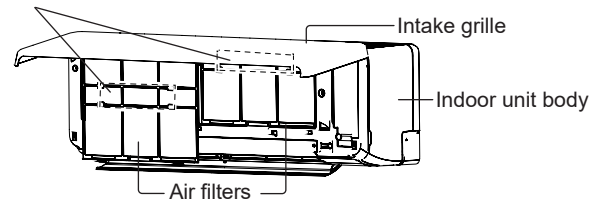

- Before cleaning this product, be sure to turn it off and disconnect all the power supply.
- Before starting operation, make sure that the intake grille has been shut completely. Incomplete closing of the intake grille might have an effect on the proper working or performance of the air conditioner.
- If the filter cleaning involves high-place work, consult authorized service personnel.
- Do not touch the aluminum fins of heat exchanger built-in the indoor unit to avoid personal injury when you maintain the unit.
- Do not expose the indoor unit to liquid insecticides or hair sprays.
- Do not stand on slippery, uneven or unstable surfaces when you maintain the unit.

Air cleaning filters

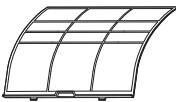

The frequency of the cleaning is as shown in the following table.

■ Frequencies at which the components are to be maintained

Name of parts	Frequency	
	Cleaning	Replacing
Indoor unit body, intake grille	When you notice	—
Air filter 	Every 2 weeks	—
Air cleaning filter (*1)		
Apple-catechin filter (UTR-FA16)  (White)	—	Every 3 months
Ion deodorization filter (UTR-FA16-2)  (Light blue)	Every 3 months	Every 3 years

*1: The air cleaning filters are sold separately. When you replace them, contact the store of purchase.

Cleaning indoor unit body

NOTES:

- Do not use water hotter than 40°C.
- Do not use scouring cleanser, volatile solvents such as benzene or thinner.

- Wipe the indoor unit body gently with a soft cloth moistened with warm water.
- Wipe the indoor unit body gently with a dry and soft cloth.

Cleaning air filter

- Open the intake grille until it snaps.

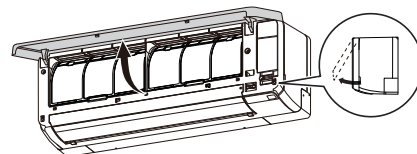

- Remove the air filters.

Lift up the air filters' handle, disconnect the two lower tabs, and pull out.

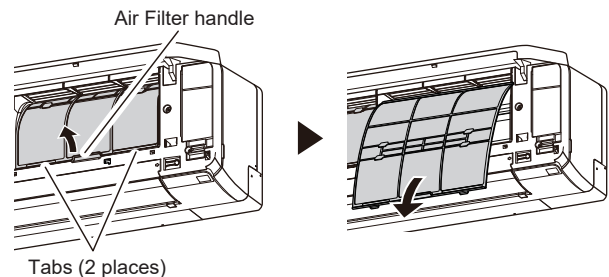

- Remove the dust in either of the following ways.

- Cleaning with a vacuum cleaner.
- Washing with mild detergent and warm water. After washing, dry the air filters thoroughly in the shade.

4. Replace the air filters.

Align the sides of the air filter with the panel, and push in fully. Make sure that the two lower tabs are returned to their holes in the indoor unit properly.

5. Close the intake grille.

Press 4 places on the intake grille to close it completely.

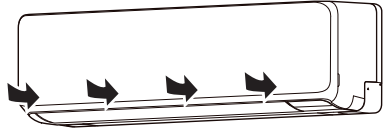

NOTE: If dirt accumulates on the air filter, airflow will be reduced, operating efficiency will lower, and the noise will increase.

Replacing air cleaning filters

NOTES:

- For the frequencies at which the air cleaning filters are to be replaced, refer to [Frequencies at which the components are to be maintained] in "CLEANING AND CARE".
- Use an air cleaning filter as soon as possible after opening the package. The air cleaning effect decreases when the filters are left in the opened package.

- Remove the air filters from indoor unit body. Refer to steps 1 ~ 2 of "Cleaning air filter".
- Remove the air cleaning filter holder and air cleaning filter from the air filter. Remove the 4 hooks of the air cleaning filter holder from the latches of the air filter.

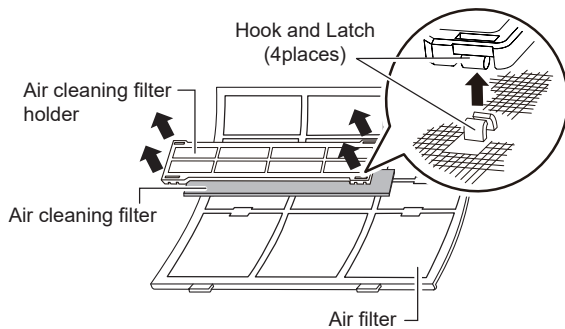

- Place a new or cleaned air cleaning filter on top of the air filter.
- Engage the latches of the air filter with the hooks of the air cleaning filter holder.

NOTE: Make sure that the air cleaning filter is within the air cleaning filter holder.

- Attach the air filter to the indoor unit body and close the intake grille. Refer to steps 4 ~ 5 of "Cleaning air filter".

Cleaning Ion deodorization filter

NOTES:

- Do not wash the Apple-catechin filter (white).
- For how to detach/attach the Ion deodorization filter, refer to "Replacing air cleaning filters".

- Wash it with water or lukewarm water. For heavy soiling, use diluent neutral detergent. Do not ream or rub, otherwise the deodorizing effect may decrease.
- Rinse the Ion deodorization filter with water flow.
- Dry the Ion deodorization filter in shade.

Removing and installing intake grille

Removing intake grille

- Open the intake grille until it snaps.
- Pull the mounting shafts while keeping the intake grille in a horizontal position.

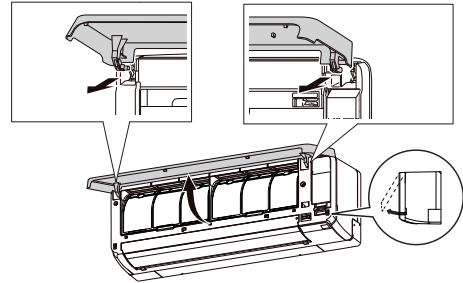

Installing intake grille

- While holding the intake grille horizontally, set the left and right mounting shafts into the pillow blocks at the top of the front panel. Insert the shaft until it snaps to latch each shaft properly.
- Close the intake grille. Press 4 places on the intake grille to close it completely.

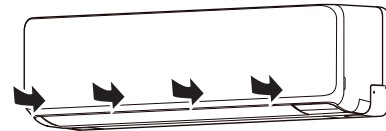

After extended non-use of the unit

If you have shut down the indoor unit for 1 month or more, perform the Fan mode operation for half a day to dry the internal parts thoroughly before the normal operation.

Additional inspection

After a long period of use, accumulated dust inside the indoor unit may reduce the performance even if you have maintained the unit properly. In such a case, a product inspection is recommended. For more information, consult authorized service personnel.

Filter indicator reset (Special setting)

This function can be used if set correctly during installation. Consult authorized service personnel in order to use this function.

☞ Clean the air filter when the indicator lamp shows the following:

Indicator lamp	Blinking pattern
	Blinks 3 times, at intervals of 21 seconds

After cleaning, reset the filter indicator by pushing on the indoor unit for 2 seconds or less.

12. GENERAL INFORMATION

■ Heating performance

This air conditioner operates on the heat-pump principle, absorbing heat from the air outdoors and transferring that heat to the indoor unit. As a result, the operating performance is reduced as outdoor air temperature drops.

If you feel that the heating performance is insufficient, we recommend you to use this air conditioner in conjunction with other kinds of heating appliances.

■ Automatic defrosting operation

When the outdoor temperature is very low with high humidity, frost may form on the outdoor unit during the heating operation, and it could reduce the operating performance of the product.

For frost protection, an automatic defrost function is equipped in this air conditioner.

If frost forms, the air conditioner will temporarily stop, and defrost circuit will operate briefly (maximum of 15 minutes.)

[] indicator on the indoor unit blinks during this operation.

If frost forms on the outdoor unit after the Heating operation, the outdoor unit will stop automatically after it operates for a few minutes. Then the Automatic defrosting operation starts.

■ Auto-restart function

In the event of a power interruption such as a blackout, the air conditioner stops once. But it restarts automatically and performs the previous operation when the power supply is resumed.

If any power interruption occurs after the timer is set, the counting down of the timer will be reset.

After the power supply is resumed, [] indicator on the indoor unit blinks to notify you that there has been a timer fault. In such a case, reset the clock and timer settings.

■ Malfunctions caused by other electrical devices

Use of other electrical appliances, such as an electric shaver or nearby use of a wireless radio transmitter, may cause the malfunction of the air conditioner.

If you encounter such a malfunction, turn off the circuit breaker once. Then turn it on again, and resume operation by the remote controller.

■ Operable conditions of temperature and humidity

Permissible ranges of temperature and humidity are as follows:

Cooling/Dry mode	Indoor temperature [°C]	18 to 32
	Indoor humidity [%]	80 or less (*1)
Heating mode	Indoor temperature [°C]	16 to 30

*1: If the air conditioner is used continuously for many hours, water may condense on the surface and drip.

- If the unit is operated under conditions except for the permissible temperature range, the air conditioner operation may stop because of the automatic protection circuit working.
- Depending on the operating conditions, the heat exchanger may freeze, causing water leakage or other malfunction (in the Cooling or Dry mode).

■ Other information

- Do not use the air conditioner for any purpose other than room cooling/dry, room heating, or fan.
- For the permissible ranges of temperature and humidity for the outdoor unit, refer to the outdoor unit specifications manual or product fiche.

13. OPTIONAL PARTS

13.1. Wired remote controller

The optional wired remote controller can be used.

You can use wired and wireless remote controllers together.

However, some functions of the wireless remote controller are restricted. If you set the restricted functions, beeps will be heard, and [], [], [] and [] indicator lamps on the indoor unit will blink.

<Restricted functions for wireless remote controller>

When using together with wired remote controller (2-wire)

- Weekly timer operation
- Powerful operation
- Outdoor Unit Low Noise operation
- 10°C Heat operation

You can use wired remote controller and wireless LAN control.

However, some operations from the mobile app are restricted.

Multiple remote controller

You can connect two wired remote controllers to one air conditioner.

Either remote controller can control the air conditioner.

However, the timer functions cannot be used by the secondary unit.

Group control

One remote controller can control up to 16 air conditioners. All of the air conditioners will be operated with the same settings.

NOTES:

- Be sure to deactivate the Energy saving program (occupancy sensor) of the wireless remote controller when you use the group control. Otherwise, you cannot operate the air conditioner by the wireless remote controller.
- You cannot use group control and wireless LAN control together.

13.2. Multi-split type air conditioner

This indoor unit can be connected to a multi-split type outdoor unit. The multi-split type air conditioner allows multiple indoor units to be operated in multiple locations. The indoor units may be operated simultaneously, in accordance with their respective output.

Simultaneous Use of Multiple Units

- When using a multi-split type air conditioner, the multiple indoor units can be operated simultaneously, but when 2 or more indoor units of the same group are operated simultaneously, the heating and cooling efficiency will be less than when a single indoor unit is used alone. Accordingly, when you wish to use more than 1 indoor unit for cooling at the same time, the use should be concentrated at night and other times when less output is required. In the same way, when multiple units are used simultaneously for heating, it is recommended that they be used in conjunction with other auxiliary space heaters, as required.
- Seasonal and outdoor temperature conditions, the structure of the rooms and the number of persons present may also result in differences of operating efficiency. We recommend that you try various operating patterns in order to confirm the level of heating and cooling output provided by your units, and use the units in the way that best matches your family's lifestyle.
- If you discover that 1 or more units deliver a low level of cooling or heating during simultaneous operation, we recommend that you stop the simultaneous operation of the multiple units.
- The operation cannot be done in the following different operating modes.

If the indoor unit is instructed to do an operating mode that it cannot perform, [] indicator on the indoor unit blinks (1 second on, 1 second off), and the unit goes into the standby mode.

Heating mode and Cooling mode (or Dry mode)

Heating mode and Fan mode

- The operation can be done in the following different operating modes.
 - Cooling mode and Dry mode
 - Cooling mode and Fan mode
 - Dry mode and Fan mode
- The operating mode (Heating mode or Cooling (Dry) mode) of the outdoor unit will be determined by the operating mode of the indoor unit that was operated first. If the indoor unit was started in the Fan mode, the operating mode of the outdoor unit will not be determined.

For example, if indoor unit (A) was started in the Fan mode and then indoor unit (B) was then operated in the Heating mode, the indoor unit (A) would temporarily start operation in the Fan mode, but when the indoor unit (B) started operating in the Heating mode, [] indicator for the indoor unit (A) would begin to blink (1 second on, 1 second off), and it would go into standby mode. The indoor unit (B) would continue to operate in the Heating mode.

14. TROUBLESHOOTING

WARNING

-  In the following events, immediately stop the operation of the air conditioner, and disconnect all the power supply by turning off the electrical breaker or disconnecting the power plug. Then consult your dealer or authorized service personnel.
- As long as the unit is connected to the power supply, it is not insulated from the power supply even if the unit is turned off.
- Unit smells of something burning or emits smoke
 - Water leaks from the unit

Does not operate at all.

- Has there been a power outage?
In this case, the unit restarts automatically after the power supply is resumed. (Refer to **page 14**.)
- Has the circuit breaker been turned off?
⇒ Turn on the circuit breaker.
- Has a fuse blown out or the circuit breaker been tripped?
⇒ Replace the fuse or reset the circuit breaker.
- Is the timer operating?
⇒ To check or deactivate the timer setting, refer to **page 6**.

Poor cooling or heating performance.

- Is the unit operating under the conditions except the permissible temperature range?
In this case, the air conditioner may stop because of the automatic protection circuit working.
- Is the air filter dirty?
⇒ Clean the air filter. (Refer to **page 12**.)
- Is the intake grille or outlet port of indoor unit blocked?
⇒ Remove the obstructions.
- Is the room temperature adjusted appropriately?
⇒ To change the temperature setting, refer to **page 5**.
- Is a window or door left opened?
⇒ Close the window or the door.
- Is the fan speed set to Quiet?
⇒ To change the fan speed, refer to **page 5**.
- Has the Outdoor Unit Low Noise operation been set?
⇒ To stop the Outdoor Unit Low Noise operation, refer to **page 8**.
- <In the Cooling mode> Is direct or strong sunlight shining into the room?
⇒ Close the curtains.
- <In the Cooling mode> Are there other heating appliance or computers operating, or too many people in the room?
⇒ Turn the heating appliance or computers off, or set the temperature lower. (Refer to **page 5**.)

Humidity does not drop during the Dry operation.

- You cannot set the target humidity in the Dry mode. If you feel high humidity, set the temperature lower.

Airflow is weak or stops.

- Is the fan speed set to Quiet?
⇒ To change the fan speed, refer to **page 5**.
- Has the Fan Control for Energy Saving set? In this case, the indoor unit fan may stop temporarily while the Cooling operation.
⇒ To cancel the Fan control for energy saving, refer to **page 8**.
- <In the Heating mode> Have you just started the operation?
In this case, the fan rotates at very low speed temporarily to warm up the internal parts of the unit.
- <In the Heating mode> Is the room temperature higher than the set temperature?
In this case, the outdoor unit stops and the indoor unit fan rotates at very low speed.
- <In the Heating mode> Is [] indicator blinking?
In this case, the Automatic defrosting operation is working. The indoor unit stops for a maximum of 15 minutes. (Refer to **page 14**.)
- <In the Dry mode> The indoor unit operates at low fan speed to adjust the room humidity, and may stop from time to time.
- <In the Auto mode> While the monitoring operation, the fan rotates at very low speed.

Noise is heard.

- Is the unit operating, or immediate after stopping operation?
In this case, refrigerant flowing sound may be heard. It may be particularly noticeable for 2-3 minutes after starting operation.
- Do you hear a slight squeaking sound during the operation?
This sound is produced by the minute expansion and contraction of the front panel caused by temperature change.
- <In the Heating mode> Do you hear a sizzling sound?
This sound is produced by the Automatic defrosting operation. (Refer to **page 14**.)

Smell coming from the unit.

- The air conditioner may absorb various smells generated from interior textile, furniture, or cigarette smoke. These smells may be emitted during the operation.

Mist or steam is emitted from the unit.

- <In the Cooling or Dry mode> A thin mist may be generated by condensation formed with sudden cooling process.
- <In the Heating mode> Is [] indicator on the indoor unit blinking?
In this case, steam may rise from the outdoor unit because of the Automatic defrosting operation. (Refer to **page 14**.)

Outdoor unit emits water.

- <In the Heating mode> The outdoor unit may emit water generated by the Automatic defrosting operation. (Refer to **page 14**.)

The unit operates differently from the remote controller setting.

- Are the batteries in the remote controller exhausted?
⇒ Replace the batteries.

Operation is delayed after restart.

- Has the power supply turned from Off to On suddenly?
In this case, the compressor will not operate for about 3 minutes to prevent a blowout of the fuse.

The mobile app does not work.

- Check that the version of the OS on your smartphone is supported.
⇒ Refer to "App Store" or "Google Play".

I have not received the e-mail when registering my account.

- Set the domain permissions so that it is not rejected as spam.

The method of registering additional air conditioners is unclear.

- To register additional air conditioners, repeat the setup of the chosen mode in "9.2. Setting to use WLAN control" for each air conditioner.

Wireless LAN setup is not possible.
<input type="checkbox"/> Check that your access point supports "WPS function." (Button mode) <input type="checkbox"/> Check if there was any previous owner using this wireless LAN control. If there was a previous owner, contact authorized service personnel.
Wireless LAN setup is not possible. (The connection settings of the WLAN adapter and access point are not complete)
<input type="checkbox"/> Check that your access point supports "IEEE 802.11 b/g/n". (Check with the operation manual of the access point.) <input type="checkbox"/> Check that the power to the indoor unit is on.
I am not able to operate this product from the mobile app.
<input type="checkbox"/> Check that the power to the indoor unit is on. <input type="checkbox"/> Check that the power to the access point is on. <input type="checkbox"/> Check that your smartphone is not in flight mode. <input type="checkbox"/> Check that you are not in a place where it is difficult to make a connection with radio waves.

Immediately stop operation and turn off the electrical breaker in the following cases. Then consult authorized service personnel.









- The problem persists even if you perform these checks or diagnostics.
- On the indoor unit, [] and [] blink while [] is blinking fast.







NOTE: For any troubleshooting related to the WLAN control, refer to the mobile app.

State of indicator lamps

 : The instruction is relating to the wireless LAN control.

Lighting pattern:  Blinking, — Any state (○ Off or ● On)

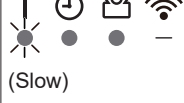
State	Causes and solutions	See page
	Automatic defrosting operation ⇒ Wait until finishing the defrosting (maximum of 15 minutes).	14
	Filter indicator ⇒ Clean the air filter and reset the filter sign.	13
	Error code display ⇒ Consult authorized service personnel.	-
	Timer setting error because of Auto restart ⇒ Reset the clock and timer settings.	14
	Test run operation (for authorized personnel only) ⇒ Press (b) to quit the test run.	3
	The power to the access point is not on. ⇒ Check that the power to the access point is on.	-
	There is a possibility that the WLAN adapter is not properly connected to the access point. ⇒ Disconnect the power supply to the air conditioner (via breaker or plug), and then re-connect.	9
	The firmware of the WLAN adapter is being updated. You cannot operate the air conditioner from the mobile app. Operate from the remote controller or wait until the update is complete (for a maximum of 5 minutes).	11
	During the air conditioner registration (pairing of WLAN adapter)	10

State	Causes and solutions	See page
	The indoor unit is preparing the firmware update. You cannot operate the air conditioner. Wait until the update is complete (for a maximum of 30 minutes).	11
 or 	<While the operation is stopped> The indoor unit is in the firmware update. You cannot operate the air conditioner. Wait until the update is complete (for a maximum of 30 minutes).	11
	Restricted function	-
	<While the operation is stopped> The firmware update of the indoor unit is complete. The settings from the wireless remote controller are initialized. Control the air conditioner from the wireless remote controller to resend the settings.	11
	<While the operation is stopped> If you cannot operate the air conditioner, the malfunction may occur on the firmware of the indoor unit. Consult authorized service personnel.	-
	(In the multi-split connection) Standby mode ⇒ Check the set operation mode of the indoor units.	14

Manual Auto operation and Filter indicator reset

You can operate the air conditioner with  on the indoor unit.

Status	Time to keep pressing	Mode or operation
In operation	More than 3 seconds	Stop
Stopping	2 seconds or less	Filter indicator reset
	More than 3 seconds and less than 10 seconds	Auto (*1)
	More than 10 seconds (Only for servicing.)(*2)	Forced cooling

*1: In multi-split connection, the operation mode follows the other indoor units.

*2: To stop the forced cooling, press this button or (b) on the remote controller.